

2023-2024

**topmaster**  
professional



topmaster professional

**2023-2024**



**BG**

Уважаеми Клиенти и Партньори,  
Имаме удоволствието да Ви представим новия продуктов каталог **Topmaster Professional**.

Марката **Topmaster Professional** е собствен бранд на Евромасер Импорт Експорт ООД, познат и утвърден на българския пазар от деветнадесет години. Разнообразието на инструментите от този бранд покрива практически целия диапазон дейности – строителство, дървообработване, металообработване, авто и градинска техника.

**Topmaster Professional** са инструменти за професионалисти, поради което тяхното най-високо качество и издръжливост са основен приоритет за нас.

Ежедневно инструментите се подлагат на специализирани тестове за издръжливост и устойчивост във водещи акредитирани и независими лаборатории, за да се гарантира спазването на най-високи стандарти за качество и безопасност. Повечето от продуктите **Topmaster Professional** са защитени с 30 години гаранция.\*

Развивайки производствената си програма през 2018 г., за улеснение в избора на точният инструмент при определена дейност, **Topmaster Professional** постави началото на ново, още по-високо

ниво със серията инструменти „Трето поколение“. То е продължение на създаденото през 2014 г. „Второ поколение“. Тази нова генерация към момента включва 120 инструмента, разпределени в 10 продуктов категории: ключове, клещи, отвертки, режещи и измервателни инструменти, такери, нитачки, чукове, строителство и градина.

Разликата между продуктите от различните поколения се обуславя основно от наличието на едни или други допълнителни функционални възможности. Това особено ясно се откроява при най-новите клещи, ключове и ролетки, някои от които силно улесняват или правят възможна работата на места, където стандартен модел (първо поколение) често би бил безполезен.

Второ и трето поколение са разделени в продуктовия каталог на марката с отличителни знаци, които правят разграничаването им от пръв поглед. Продуктите от първо поколение са без отличителен знак.

След утвърждаването на продуктите в България, **Topmaster Professional** успешно разширява дистрибуторската си мрежа и пазарния си дял в редица страни от Централна, Източна Европа, Африка и Близкия Изток.

**EN**

Dear Clients & Partners,  
We have the honor to present you the new **Topmaster Professional** product catalogue.

**Topmaster Professional** is Euromaster Import - Export Ltd's own brand, known & established on the Bulgarian market for already 19 years. The brand's tool variety covers practically the whole range of activities: building, woodworking, metalworking, automotive & garden equipment.

**Topmaster** products are tools for professionals, which is why their highest quality & endurance are our fundamental priorities.

On a daily basis the tools are subjected to specialized tests for endurance & durability in leading, accredited & independent laboratories in order to guarantee compliance with the highest standards of quality & safety. Most Topmaster products are covered by a 30 years warranty.\* By developing its production program in 2018, in order to ease up the choice of the right tool for a particular field of business, Topmaster has launched a new, even higher level with the "Third Generation" series. It is a continuation of the created in 2014 "Second Generation" series. This new generation currently includes 120 tools, distributed within 10

product categories: Wrenches, Pliers, Screwdrivers, Cutting & Measuring Tools, Stapler Guns, Riveters, Hammers, Construction & Gardening Tools.

The difference between products of different generations is mainly in the presence of some or other additional functionalities. This is particularly clear with the latest pliers, wrenches and measuring tapes, some of which make it easy to access & work in places where a standard model (First Generation) often would be rendered useless.

The 2<sup>nd</sup> and 3<sup>rd</sup> generations are divided into the product catalogue of the brand with distinctive logos that distinguish them at first glance. The 1<sup>st</sup> Generation products are basic professional models and without a distinctive logo.

After the establishment of its products in Bulgaria, Topmaster Professional successfully expands its distributional network & market share in a number of countries in Central & Eastern Europe, Africa & The Middle East.

**RO**

Dragi parteneri,  
Avem placerea sa va prezentam noul catalog **Topmaster Profesional**.

**Topmaster Profesional** este brandul EuroMaster Import – Export Ltd, fondat in urma cu 19 ani. Varietatea brandului acopera o gama diversa de activitati: constructii, prelucrarea lemnului, prelucrarea metalelor, auto si de gradina.

Produsele **Topmaster** sunt unelte pentru profesionisti, de aceea calitatea si rezistenta sunt prioritatile noastre.

Produsele sunt supuse continuu la teste de rezistenta si durabilitate in laboratoare acreditate independente pentru a garanta respectarea celor mai inalte standarde de calitate. Majoritatea produselor Topmaster sunt acoperite de o garantie de 30 de ani.\* Prin dezvoltarea programului sau de productie in 2018, pentru a usura alegerea uneltei potrivite pentru un anumit domeniu de activitate, **Topmaster** a lansat seria "a treia generatie". Este o continuare a celei de-a doua generatii creata in 2014.

Aceasta noua serie include in prezent 120 de scule de mana, distribuite in 10 categorii de produse: chei, clesti, surubelnite, unelte de taiere si masurare, pistoale pentru capsat, clesti pop nituri, ciocane, unelte pentru constructii si gradinarit.

Diferenta dintre produsele din generatii diferite este in principal in prezenta unor functii suplimentare. Acest lucru este deosebit de clar cu cei mai recenti clesti, chei si rulete, dintre care unele faciliteaza accesul si munca in locuri unde un model standard (prima generatie) ar fi de multe ori inutil.

Generatiile a doua si a treia sunt impartite in catalogul de produse al marcii, cu logo-uri distincte. Produsele din prima generatie sunt modele profesionale de baza si nu au un logo propriu.

De-a lungul timpului, **Topmaster Profesional** si-a extins cu succes retea de distributie in mai multe tari din Europa Centrala si de Est, Africa si Orientul Mijlociu.

\* **BG** - Можете да намерите гаранционните условия на сайта [www.topmaster.bg](http://www.topmaster.bg). **EN** - The warranty terms & conditions can be found on [www.topmaster.bg](http://www.topmaster.bg). **RO** - Termenii si conditiile de garantie pot fi gasite pe [www.topmaster.bg](http://www.topmaster.bg).





**Евромастер Импорт - Експорт ООД** е основана през 1992 г. и днес заема водещо място на пазара на професионалните и хоби инструменти в България, постигайки устойчив растеж през годините.

Нашата мисия, вече 28 години, е да задоволяваме потребителското търсене, спазвайки Европейските стандарти за качество, като произвеждаме, доставяме, развиваме и разширяваме асортимента ни от висококачествени продукти.

Най-важните предпоставки за успех на компанията са: **Опитът**, натрупан от изучаване на световните тенденции в търговията с електро и механични инструменти; **Куражът**, да се следва по-трудния, но в перспектива по-успешен път на създаване, развиване и налагане на собствени марки; **Доверието** към всеки служител на фирмата и всеки бизнес партньор.

Ние знаем в какво сме най-добри и сме насочили цялата си енергия към затвърждаването на позициите ни като лидер на българския пазар. Фокусирани сме върху това да вършим прекрасно работата си, да създаваме инструменти и машини, които да направят живота Ви по-лек и по-добър. Стремим се да бъдем блестящи във всеки детайл, давайки изключителна стойност на нашите продукти.

Така постигаме своите успехи.

**Euromaster Import - Export Ltd.** was founded in 1992 and today occupies a leading position in the market of professional and hobby tools in Bulgaria, achieving a sustainable level of growth over the years.

Our mission for 28 years now, has been to meet the consumer demand, complying with European quality standards by manufacturing, supplying, developing and expanding our range of high quality products.

The most important prerequisites for the company's success are: **Experience** gained from the study of global trends in the trade of power and hand tools; **Courage** to follow the more difficult, but in perspective the more successful way of creating, development and enforcement of own brands; **Trust** in each company employee and business partner.

We know what we are good at and direct all our energy to strengthen our position as a leader on the Bulgarian market. We are focused on doing our job perfectly, to create hand and power tools and to make your life easier and better. We strive to be brilliant in every detail, providing exceptional value to our products.

That is how we achieve our successes.

## ЕВРОМАСТЕР Импорт Експорт ООД

Р. България, 1231 София,  
бул. "Ломско шосе" 246  
тел.: 0700 44 155 за цялата страна  
e-mail: info@euromasterbg.com  
www.euromasterbg.com

## EUROMASTER Import Export Ltd.

Bulgaria, 1231 Sofia,  
246 Lomsko Shose Blvd.  
tel.: +359 87 530 0101  
e-mail: info@euromasterbg.com  
www.euromasterbg.com

## EUROMASTER SRL Romania

Str. Drumul Garii Otopeni,  
Nr. 6, Otopeni, Ilfov  
tel.: +4 021 3510106  
e-mail: info@euromasters.ro  
www.euromasters.ro

"Евромастер Импорт - Експорт" ООД, информира, че авторските права на този каталог, включващи неговия текст, поместените фотографии, пиктограми, схеми, чертежи и дизайн, принадлежат изключително на "Евромастер Импорт - Експорт" ООД и подлежат на правна защита съгласно „Закона за авторското право и сродните му права“ влязъл в сила на 01.08.1993 г. и последните изменения публикувани в „Държавен вестник“ бр. 32 от 28 Април 2009 г.

Копирането, публикуването, модифицирането с комерсиална цел на каталога, както и на отделни елементи от него без съгласието на "Евромастер Импорт Експорт" ООД, изразено в писмена форма, е строго забранено и може да доведе до подвеждане под отговорност.

All rights reserved. Euromaster Import - Export Ltd informs that the copyright of this catalog, including its text, photographs, pictograms, diagrams, drawings and designs belong exclusively to Euromaster Import - Export Ltd and are subject to legal protection.

Copying, publishing, modifying the catalog with commercial purposes, as well as individual elements thereof without the consent of Euromaster Import - Export Ltd expressed in written form is strictly prohibited and may result in liability.



www.topmaster.bg



# СЪДЪРЖАНИЕ

## ВЛОЖКИ, АКСЕСОАРИ И КОМПЛЕКТИ SOCKETS, ACESSORIES & SETS

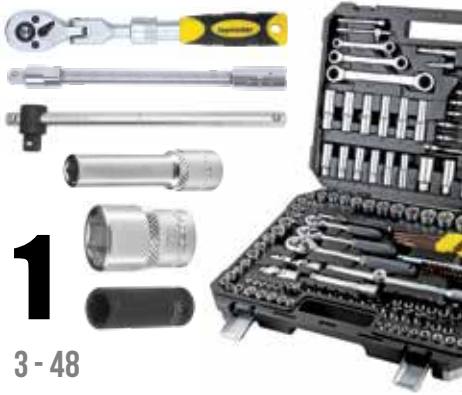

**1**

3 - 48

## КЛЮЧОВЕ SPANNERS



**2**

49-68

## ОТВЕРТКИ И НАКРАЙНИЦИ SCREWDRIVERS & BITS



**3**

69-96

## КЛЕЩИ PLIERS



**4**

97-128

## ИЗМЕРВАТЕЛНИ MEASURING TOOLS



**5**

129-142

## ЧУКОВЕ И ДЛЕТА HAMMERS, CHISELS, PUNCHES & AXES



**6**

143-154

## РЕЖЕЩИ CUTTING TOOLS



**7**

155-180

## ТАКЕРИ И НИТАЧКИ FASTENING TOOLS



**8**

181-186

## СТРОИТЕЛСТВО BUILDING TOOLS



**9**

187-196

## СПЕЦИАЛИЗИРАНИ АВТОИНСТРУМЕНТИ SPECIAL AUTOMOTIVE TOOLS & EQUIPMENT



**10**

197-222

## ГРАДИНА GARDEN TOOLS



**11**

223-234

## РАБОТНИ ОБЛЕКЛА И ОБУВКИ WORKING CLOTHES & SAFETY SHOES



**12**

235 - 250











## РЕКЛАМНИ ПРОДУКТИ ADVERTISING PRODUCTS



**13**

251-256



 Сътветства на DIN стандарт Compliant with DIN standard	 Напрежение Voltage	 Лампа Light	 Профил за намаляване на усието Super drive broach
 CE сертификат CE certificate	 Студено пресован Cold stamped	 Силен магнитен накрайник Strong magnetic hook	 Натоварване върху всички стени на вложката Superlock system
 GS/TÜV сертификат GS/TÜV certificate	 Изцяло полиран Fully polished	 MID сертификат MID certificate	 Пила за дърво Wood cutting
EN 60900:2004 Европейски стандарт European standart	 24 зъба 24 teeth	 Дебелина на лентата thickness blade	 Пила плоска Flat file
 Сертификат за работа до 1000V VDE certificate	 48 зъба 48 teeth	 Измерва в милиметри и инчове Millimetre and inch measurement	 Пила полуобла Half-rounded file
 Никелово покритие Nickel finish	 72 зъба 72 teeth	 Диапазон Range	 Пила квадратна Square file
 Магнит Magnet	 Реверс Revers	 Дебелина на профила Thickness of profile walls	 Пила за метал For metal
 Плосък връх Slotted tip	 Наклон на главата 15° Head offset 15°	 Три либели Number of levels	 Пила триъгълна Triangular file
 Връх тип phillips Phillips tip	 Наклон на челюстите Jaws offset	 Двоен стоп Additional tape block	 Пила обла Rounded file
 Връх тип pozidriv Pozidriv tip	 Тип на челюстите Jaws type	 Степен на точност Error range	 4 накрайника с различни размери 4 nosepieces of diferent sizes
 Връх тип Torx Torx tip	 Стомана #45 Steel #45	 Манган #65 Manganese #65	 Алуминиеви нитове Breaks aluminium rivets
 Шестограмен връх Hexagonal tip	 Прецизно полирани Fully polished micro finished	 7 зъба на инч 7 teeth per inch	 Стоманени нитове Breaks steel rivets
 Шестограмен връх специал Hexagonal rounded bit	 Твърдост Hardness	 По-бързо рязане Fast cut	 Нитове от неръждаема стомана Breaks stainless steel rivets
 шестограм Torx с отвор Torx with hole	 Силикон-ванадиева-хром-магнезиева стомана Silicon-vanadium-chrome-magnesium	 Закалени зъби Hardened teeth	 Дължина на скобите Staples length
 плосък връх slotted tip	 Хром-ванадиева стомана Chrome-vanadium steel	 Тристранно заточени Triangular sharpened	 Размер на скобите Staple size
 връх тип phillips phillips tip	 Хром-ванадиева стомана Chrome-vanadium steel	 Рязане и в двете посоки Two way cutting	 Размер на пироните Nail size
 връх тип Torx torx tip	 Хром-молибденова стомана Chrome-molibdenum steel	 Рязане на газобетон Concrete cutting	 Дължина на скобите Staples length
 шестстенна вложка hexagonal socket	 Неръждаема стомана Stainless steel	 Метален водач на ножа Metal blade guides	 Брой в комплект Quantity in set or package
 връх тип pozidriv pozidriv tip	 Висококачествена инструментална стомана T12 Super hard steel T12	 Тройно заточени Triple sharpened	 2 броя 2 pieces
 12-стенна вложка 12-point socket	 Висококачествена инструментална стомана Super hard steel	 Дебелина на ножа Blade thickness	 Диаметър Diameter



# 1

## *ВЛОЖКИ, АКСЕСОАРИ И КОМПЛЕКТИ* *SOCKETS, ACCESSORIES & SETS*





## HEXAGONAL SOCKET

- [BG] Вложка • [RO] Cheie tubulara` • [EL] Καρυδάκι εξάγωνο • [PT] Chave de caixa • [IT] Bussola • [SR] Nasadni ključ • [SI] Nasadni ključ
- [BH] Natikač • [RU] Головка сменная шестигранная • [MK] Ключ насаден

Art. № Art. №	Размер Size (mm)	D (mm)	d (mm)	l (mm)	t (mm)	t' (mm)	MINIMUM TEST TORQUES (Nm)	Баркод Barcode
330490	1/4" x 6	11.8	9.2	25	8	3.5	20.6(2.06)	
330491	1/4" x 7	11.8	10.8	25	8	4	26.8(2.68)	
330492	1/4" x 8	10.8	11.8	25	8	5	33.6(3.36)	
330493	1/4" x 9	11.6	12.8	25	8	5	41.1(4.11)	
330494	1/4" x 10	12.5	14.5	25	8	6	49.1(4.91)	
330495	1/4" x 11	13.9	15.8	25	8	7	57.8(5.78)	
330496	1/4" x 12	14.7	16.8	25	8	8	67.0(6.7)	
330497	1/4" x 13	15.7	17.8	25	8	8	68.6(6.86)	

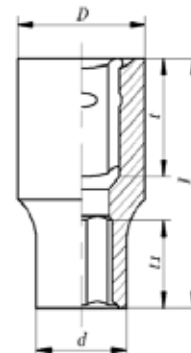

## HEXAGONAL SOCKET

- [BG] Вложка • [RO] Cheie tubulara` • [EL] Καρυδάκι εξάγωνο • [PT] Chave de caixa • [IT] Bussola • [SR] Nasadni ključ • [SI] Nasadni ključ
- [BH] Natikač • [RU] Головка сменная шестигранная • [MK] Ключ насаден

Art. № Art. №	Размер Size (mm)	D (mm)	d (mm)	l (mm)	t (mm)	t' (mm)	MINIMUM TEST TORQUES (Nm)	Баркод Barcode
330440	1/4" x 6	9.2	12	25	8	3.5	20.6 (2.06)	
330444	1/4" x 7	10.5	12	25	8	4	26.8 (2.68)	
330441	1/4" x 8	12	12	25	8	5	33.6 (3.36)	
330446	1/4" x 9	13	12	25	8	5	41.1 (4.11)	
330442	1/4" x 10	14	13	25	8	6	49.1 (4.91)	
330447	1/4" x 11	16	14	25	8	7	57.8 (5.78)	
330445	1/4" x 12	17	15	25	8	8	68.6 (6.86)	
330443	1/4" x 13	18	18	16	8	8	68.6 (6.86)	

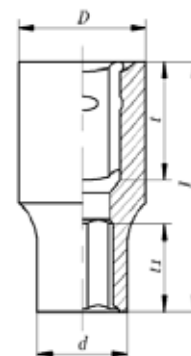

# HEXAGONAL DEEP SOCKET

- [BG] Вложка удължена • [RO] Cheie tubulara adanca
- [EL] Καρυδάκι εξάγωνο μακρύ • [PT] Chave caixa longa
- [IT] Bussola profonda • [SR] Nasadni ključ produženi
- [SL] Nasadni ključ dolgi • [BH] Natikač
- [RU] Удлиненная Шестигранная Головка
- [MK] Клуч насаден продолжен

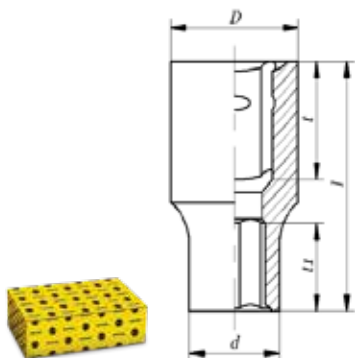

CR-V 50BV30 STEEL DIN 3124 1/4"

Art. № Art. №	Размер Size (mm)	D (mm)	d (mm)	l (mm)	t (mm)	t' (mm)	MINIMUM TEST TORQUES (Nm)	Баркод Barcode
330413	1/4" x 4	11.8	6.6	50	8	3	10.4	
330414	1/4" x 4.5	11.8	7.2	50	8	3.4	12.6	
330415	1/4" x 5	11.8	8	50	8	3.7	15.1	
330416	1/4" x 5.5	11.8	8.5	50	8	4.5	17.8	
330417	1/4" x 6	11.8	9.2	50	8	5.2	20.6	
330418	1/4" x 7	11.8	10.8	50	8	6	26.8	
330419	1/4" x 8	10.8	11.8	50	8	7.5	33.6	
330420	1/4" x 9	11.6	12.8	50	8	7.5	41.1	
330421	1/4" x 10	12.5	14.5	50	8	9	49.1	
330422	1/4" x 11	13.9	15.8	50	8	10.5	57.8	
330423	1/4" x 12	14.7	16.8	50	8	12	67	
330424	1/4" x 13	15.7	17.8	50	8	12	68.6	

# HEXAGONAL DEEP SOCKET

- [BG] Вложка удължена • [RO] Cheie tubulara adanca
- [EL] Καρυδάκι εξάγωνο μακρύ • [PT] Chave caixa longa
- [IT] Bussola profonda • [SR] Nasadni ključ produženi
- [SL] Nasadni ključ dolgi • [BH] Natikač
- [RU] Удлиненная Шестигранная Головка
- [MK] Клуч насаден продолжен



2<sup>ND</sup> GENERATION

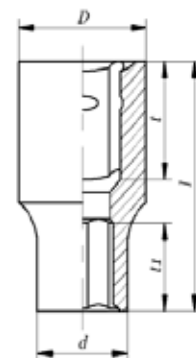

CR-V 50BV30 STEEL DIN 3124 1/4"

Art. № Art. №	Размер Size (mm)	D (mm)	d (mm)	l (mm)	t (mm)	t' (mm)	MINIMUM TEST TORQUES (Nm)	Баркод Barcode
330362	1/4" x 4	12	6.8	50	8	3	10.4	
330363	1/4" x 4.5	12	7.4	50	8	3.4	12.6	
330364	1/4" x 5	12	8	50	8	3.7	15.1	
330106	1/4" x 6	12	9.2	50	8	5.2	20.6	
330107	1/4" x 7	12	10.5	50	8	6	26.8	
330108	1/4" x 8	11	12	50	8	7.5	33.6	
330109	1/4" x 9	12	13	50	8	7.5	41.1	
330110	1/4" x 10	12	14	50	8	9	49.1	
330111	1/4" x 11	14	16	50	8	10.5	57.8	
330112	1/4" x 12	15	17	50	8	12	67	
330113	1/4" x 13	16	18	50	8	12	68.6	



## SOCKET E-TORX

- [BG] Вложка Е - TORX • [RO] Cheie tubulara E-TORX • [EL] Καρυδάκι e-torx • [PT] Chave E-Torx • [IT] Bussola • [SR] Nastavak na gedori E-TORX
- [SL] Nasadni ključ • [BH] Natikač • [RU] Сменная Головка Е - Torx • [MK] Ключ насаден

Art. № Art. №	Размер Size (mm)	D (mm)	d (mm)	l (mm)	t (mm)	t1 (mm)	MINIMUM TEST TORQUES (Nm)	Баркод Barcode
331400	1/4" x 6	12	8.1	25	8	6	120	
331401	1/4" x 7	12	8.9	25	8	7	130	



2<sup>ND</sup>  
GENERATION

30  
YEARS  
WARRANTY



CR-V  
50BV30  
STEEL

1/4"



## SLOTTED BIT SOCKET

- [BG] Вложка с накрайник • [RO] Bit tubulara ST • [EL] Μύτη κατσαβίδι ίσιο καρυδάκι • [PT] Chave Bits • [IT] Bussola Bit
- [SR] Nastavak na gedori ravni • [SL] Nastavek ploščati • [BH] Bit • [RU] Головка С Наконечником • [MK] Ключ насаден заштрафувач

Art. № Art. №	Размер Size		l (mm)	Баркод Barcode
330193	1/4"	7	37	



CR-V  
50BV30  
STEEL

1/4"



## PHILLIPS BIT SOCKET

- [BG] Вложка с накрайник • [RO] Bit tubulara PH • [EL] Μύτη κατσαβίδι σταυρός καρυδάκι • [PT] Chave Bits • [IT] Bussola Bit
- [SR] Nastavak na gedori krstasti • [SL] Nastavek ploščati • [BH] Bit • [RU] Головка С Наконечником • [MK] Ключ насаден заштрафувач

Art. № Art. №	Размер Size		l (mm)	Баркод Barcode
330194	1/4"	PH0	37	
330195	1/4"	PH1	37	
330197	1/4"	PH3	37	



CR-V  
50BV30  
STEEL

1/4"



## POZIDRIV BIT SOCKET

- [BG] Вложка с накрайник • [RO] Bit tubulara PZ • [EL] Μύτη κατσαβίδι PZ καρυδάκι • [PT] Chave bits • [IT] Bussola Bit
- [SR] Nastavak na gedori krstasti PZ • [SL] Nastavek ploščati • [BH] Bit • [RU] Головка с наконечником
- [MK] Ключ насаден заштрафувач

Art. № Art. №	Размер Size		l (mm)	Баркод Barcode
330198	1/4"	PZ1	37	



CR-V  
50BV30  
STEEL

1/4"



## TORX BIT SOCKET

- [BG] Вложка с накрайник • [RO] Bit tubulara Torx • [EL] Μύτη κατσαβίδι torx καριδάκι • [PT] Chave Bits • [IT] Bussola Bit
- [SR] Nastavak na gedori TORX • [SL] Nastavek ploščati • [BH] Bit • [RU] Головка С Наконечником • [MK] Ключ насаден заштрафувач

Art. № Art. №	Размер Size	L (mm)	I (mm)	D (mm)	Баркод Barcode
331601	1/4" T8	37	19	11.8	
331602	1/4" T10	37	19	11.8	
331603	1/4" T15	37	19	11.8	
331604	1/4" T20	37	19	11.8	
331605	1/4" T25	37	19	11.8	
331606	1/4" T27	37	19	11.8	
331607	1/4" T30	37	19	11.8	



2<sup>ND</sup>  
GENERATION

30  
YEARS  
WARRANTY



CR-V  
50BV30  
STEEL

1/4"



## ADAPTER

- [BG] Адаптер • [RO] Adapter • [EL] Αντάπτορας καστάνιας • [PT] Adaptador • [IT] Adattatore
- [SR] Adapter za nastavke • [SL] Adapter • [BH] Adapter • [RU] Переходник • [MK] Адаптер

Art. № Art. №	Размер Size	Баркод Barcode
330300	1/4"(F) x 3/8"(M)	



CR-V  
50BV30  
STEEL

1/4"



## EXTENSION BAR

- [BG] Удължение • [RO] Adapter lung
- [EL] Καστάνιας προέκταση • [PT] Alongador
- [IT] Bussola lunga • [SR] Produžetak za nasadni ključ
- [SL] Podaljšek • [BH] produžetak za patikače
- [RU] Удлинитель • [MK] Продолжеток

арт. № art. №	Размер Size (mm)	L (mm)	Баркод Barcode
330185	1/4" x 50	50	
330186	1/4" x 100	100	
330188	1/4" x 150	150	

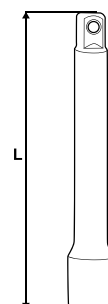

CR-V  
50BV30  
STEEL





1/4"





## WOBBLE EXTENSION BAR



- [BG] Удължение за работа под ъгъл • [RO] Adapter lung
- [EL] Κασάνιας προέκταση • [PT] Alongador • [IT] Bussola lunga
- [SR] Produžetak za nasadni ključ • [SL] Podaljšek gibljiv
- [BH] produžetak za natikače • [RU] Удлинитель • [MK] Продолжеток

арт. № art. №	Размер Size (mm)	L (mm)	Баркод Barcode
330171	1/4" x 50	50	
330172	1/4" x 75	75	
330173	1/4" x 100	100	
330174	1/4" x 150	150	
330175	1/4" x 250	250	



## FLEXIBLE EXTENSION BAR

- [BG] Удължител за накрайници гъвкав • [RO] Adapter flexibil
- [EL] Κασάνιας προέκταση ευκάμπτη • [PT] Porta Bits magnético
- [IT] Barra di estensione • [SR] Produžetak za nasadni ključ FLEX • [SL] Podaljšek
- [BH] produžetak za natikače • [RU] Удлинитель
- [MK] Флексибилен продолжеток

арт. № art. №	Размер Size	L (mm)	Баркод Barcode
330401	1/4"	145	
342901	1/4"	200	



## ADAPTER

- [BG] Адаптер за накрайници • [RO] Adapter
- [EL] Αντάπτορας μύτης για κασάνια • [PT] Adaptador
- [IT] Adattatore • [SR] Adapter za nastavke • [SL] Adapter
- [BH] Adapter • [RU] Переходник • [MK] Адаптер

Арт. № Art. №	Размер Size	L (mm)	Баркод Barcode
330366	1/4"x1/4" F	23	

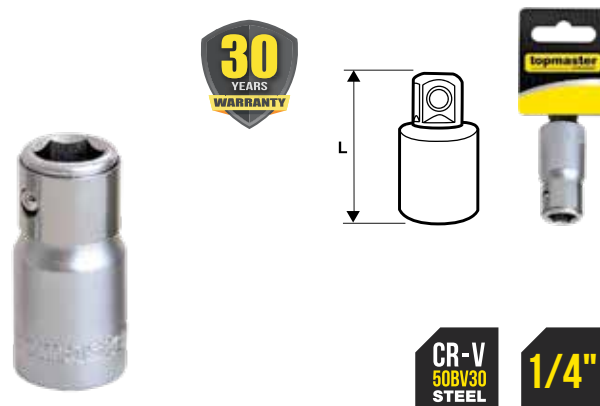

## BIT ADAPTER

- [BG] Адаптер • [RO] Adapter bit • [EL] Ανταπτορας μυτης για καστανια
- [PT] Adaptador • [IT] Adattatore • [SR] Adapter za nastavke • [SL] Adapter
- [BH] Adapter • [RU] Переходник • [MK] Адаптер

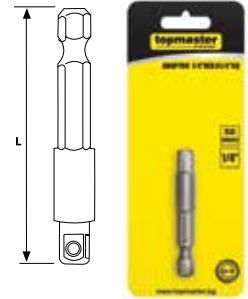

Арт. № Art. №	Размер Size	L (mm)	Баркод Barcode
330367	1/4" HEX x 1/4" F SQ	50	 3 800123 162626



## PENTA SOCKET BIT SET

- [BG] Вложки с накрайник • [RO] Bit tubulara • [EL] Μύτη κατσαβίδι καρυδάκι torx με τρύπα σετ
- [PT] Chave Bits • [IT] Bussola Bit • [SR] Nastavak na gedori TORX • [SL] Nastavek zvezda • [BH] Bit
- [RU] Набор Головок С Наконечниками • [MK] Битови сет



Арт. № Art. №	Размер Size	Баркод Barcode
330149	1/4" TS8 - 40	 3 4800972 003521

SIZES: TS8, TS10, TS15, TS20, TS25, TS27, TS30, TS40



## SLIDING T-BAR

- [BG] Върток подвижна "Т" - дръжка • [RO] Levier strangere • [EL] Μανελα ταφ • [PT] Chave T deslizante
- [IT] Leva di serraggio satinata • [SR] T ručica za gedoru • [SL] ROČICA \*T\* • [BH] Klizač • [RU] Ворток
- [MK] Насаден клуч со Т рачка

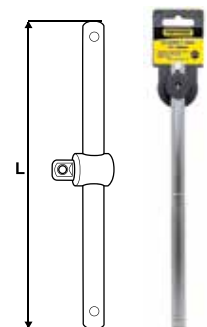

Арт. № Art. №	Размер Size	L (mm)	Баркод Barcode
330152	1/4"	100	 3 800123 114638 11





## FLEXIBLE HANDLE

- [BG] Върток • [RO] Maner flexibil • [EL] Μανέλα ρυθμιζόμενη • [PT] Chave • [IT] Leva di serraggio satinata
- [SR] Ručica za gedoru zglobna • [SL] Gibljiv ročaj • [BH] Račna mehaničarska • [RU] Вороток • [MK] Држач

30  
YEARS  
WARRANTY

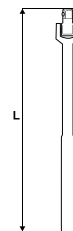

Cr-V  
STEEL

1/4"

Art. №  
Art. №      Размер  
Size      L  
(mm)      Баркод  
Barcode

336909

1/4"

150



## SPINNER HANDLE

- [BG] Върток • [RO] Maner tubulare • [EL] Κατσαβίδι αντάπτορας για καρδιάκι • [PT] Chave
- [IT] Leva di serraggio satinata • [SR] Ručica za gedoru • [SL] Gibljiv ročaj • [BH] Račna mehaničarska
- [RU] Вороток • [MK] Држач

30  
YEARS  
WARRANTY



Cr-V  
STEEL

1/4"

Art. №  
Art. №      Размер  
Size      L  
(mm)      Баркод  
Barcode

330156

1/4"

150



## UNIVERSAL JOINT

- [BG] Кардан • [RO] Cuplaj cardanic • [EL] Πολύσπαστο
- [PT] Chave • [IT] Leva di serraggio satinata • [SR] Adapter za gedoru
- [SL] Gibljiv ročaj • [BH] Račna mehaničarska • [RU] Вороток • [MK] Кардански зглоб

30  
YEARS  
WARRANTY

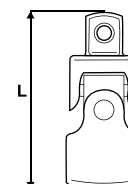

CR-V  
50BV30  
STEEL

DIN  
3123

1/4"

Art. №  
Art. №      Размер  
Size      L  
(mm)      Баркод  
Barcode

330164

1/4"

40



## TWISTING RATCHET HANDLE

- [BG] Тресчотка с въртяща дръжка • [RO] Clichet cu maner rotativ • [EL] Κασάνια ρυθμιζόμενη
- [PT] Roquete • [IT] Cricchetto a manico rotante • [SR] Čegrtaljka • [SL] Raglja z vrtljivo ročico
- [BH] Račna • [RU] Трещотка с Вращающейся Ручкой • [MK] Двонасочна крцкалка со вртлива рачка

30  
YEARS  
WARRANTY

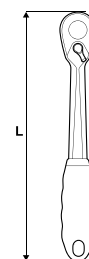

Cr-V  
STEEL

60

1/4"

арт. №  
art. №      Размер  
Size      L  
(mm)      Зъби  
Teeth      Баркод  
Barcode

336701

1/4"

180

60



## RATCHET HANDLE EXTENSION

- [BG] Тресчотка с телескопична дръжка • [RO] Maner clichet extensibil • [EL] Καστάνια αρθρωτή τηλεσκοπική
- [PT] Roquete • [IT] Chiave a cricchetto • [SR] Čegrtaljka • [SL] Raglja • [BH] Račna
- [RU] Трещотка с телескопической ручкой • [MK] Телескопска рачка со крцкало



арт. № art. №	Размер Size	L (mm)	Зъби Teeth	Баркод Barcode
336906	1/4"	160-210	72	



## RATCHET HANDLE EXTENSION

- [BG] Тресчотка с телескопична дръжка • [RO] Maner clichet extensibil • [EL] Καστάνια αρθρωτή τηλεσκοπική
- [PT] Roquete • [IT] Chiave a cricchetto • [SR] Čegrtaljka zglobna • [SL] Teleskopska raglja • [BH] Račna
- [RU] Трещотка С Телескопической Ручкой • [MK] Телескопска рачка со крцкало



арт. № art. №	Размер Size	L (mm)	Зъби Teeth	Баркод Barcode
336908	1/4"	185 - 235	72	



## SLIM RATCHET HANDLE

- [BG] Тресчотка • [RO] Maner clichet • [EL] Καστάνια • [PT] Roquete • [IT] Chiave a cricchetto
- [SR] Čegrtaljka • [SL] Teleskopska raglja • [BH] Račna • [RU] Трещотка • [MK] Рачка со крцкало



арт. № art. №	Размер Size	L (mm)	Зъби Teeth	Баркод Barcode
330342	1/4"	140	48	





## RATCHET HANDLE

- [BG] Тресчотка • [RO] Maner clichet • [EL] Καστάνια • [PT] Roquete • [IT] Chiave a cricchetto • [SR] Čegrtaljka
- [SL] Raglja • [BH] Račna • [RU] Трещотка • [MK] Рачка со крцкало



арт. № art. №	Размер Size	L (mm)	Зъби Teeth	Баркод Barcode
330167	1/4"	150	72	



## RATCHET HANDLE

- [BG] Тресчотка • [RO] Maner clichet • [EL] Καστάνια • [PT] Roquete • [IT] Chiave a cricchetto • [SR] Čegrtaljka
- [SL] Raglja • [BH] Račna • [RU] Трещотка • [MK] Рачка со крцкало



арт. № art. №	Размер Size	L (mm)	Зъби Teeth	Баркод Barcode
336903	1/4"	155	72	



## BI - HEXAGONAL SOCKET SET

- [BG] Вложки комплект 12-стенни • [RO] Set tubulare • [EL] Καστάνια сет • [PT] Roquete • [IT] Chiave a cricchetto
- [SR] Nasadni ključevi na šini • [SL] Set nastavkov z ragljo • [BH] Natikač set • [RU] Набор Головок • [MK] Гарнитура насадни клучеви



арт. № art. №	Размер Size	Баркод Barcode
331610	1/4"	



## SOCKET SET E-TORX

- [BG] Вложки E-TORX комплект • [RO] Set tubulare E-Torx • [EL] Καρυδάκια σετ e-torx • [PT] Jogo 10 chaves torx • [IT] Kit bussole
- [SR] Nasadni ključevi na šini • [SL] Set nastavkov • [BH] Natikač set • [RU] Набор E-Torx Головок • [MK] Гарнитура насадни клучеви



арт. № art. №	Размер Size	Баркод Barcode
330148	1/4"-3/8"	



## HEXAGONAL DEEP SOCKET

- [BG] Вложка удължена • [RO] Tubulara adanca • [EL] Καρυδάκι εξαγώνο μακρό • [PT] Chave caixa longa • [IT] Bussola profonda
- [SR] Nasadni ključ produženi • [SL] Šestkotni dolgi nasadni ključ • [BH] Natikač • [RU] Удлиненная Головка • [MK] Клуч насаден продолжен

Арт. № Art. №	Размер Size (mm)	D (mm)	d (mm)	l (mm)	t (mm)	t <sub>1</sub> (mm)	MINIMUM TEST TORQUES (Nm)	Баркод Barcode
330114	3/8" x 8	17	12	63	11.5	5	45.5	
330116	3/8" x 10	17	14.5	63	11.5	9	76.7	
330117	3/8" x 11	17	15.7	63	11.5	10.5	96	
330118	3/8" x 12	16	17	63	11.5	12	118	
330119	3/8" x 13	16.5	18	63	11.5	12	141	
330120	3/8" x 14	17	19.7	63	11.5	15	169	
330121	3/8" x 15	19	21	63	11.5	15	198	
330123	3/8" x 17	20	23.5	63	11.5	15	225	

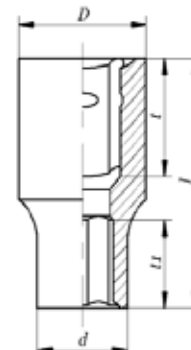

## SLOTTED BIT SOCKET



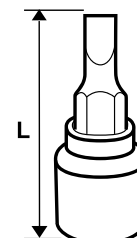

- [BG] Вложка с накрайник • [RO] Bit tubulara ST • [EL] Μύτη κατσαβίδι ίσιο καρυδάκι • [PT] Chave Bits • [IT] Bussola Bit
- [SR] Nastavak na gedori prjosnati • [SL] Nastavek ploščati • [BH] Bit • [RU] Наконечник • [MK] Клуч насаден заштрафувач

Арт. № Art. №	Размер Size	⌀	L (mm)	Баркод Barcode
330282	3/8"	4	48	
330283	3/8"	6	48	
330284	3/8"	8	48	



## POZIDRIV BIT SOCKET

- [BG] Вложка с крайник • [RO] Bit tubulara PZ • [EL] Μύτη κατσαβίδι σταυρός καρδιάκι • [PT] Chave Bits • [IT] Bussola Bit
- [SR] Nastavak na gedori PZ • [SL] Nastavek zvezda • [BH] Bit • [RU] Головка С Наконечником
- [MK] Клуч насаден заштрафувач

Art. № Art. №	Размер Size		L (mm)	Баркод Barcode
330285	3/8"	PZ1	48	
330286	3/8"	PZ2	48	
330287	3/8"	PZ3	48	

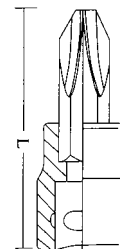

CR-V  
50BV30  
STEEL



3/8"



## EXTENSION BAR

- [BG] Удължение • [RO] Adapter lung • [EL] Κασάνιας προέκταση
- [PT] Alongador • [IT] Bussola lunga • [SR] Nastavak za nasadni ključ
- [SL] Podaljšek gibljiv • [BH] produžetak za natikače • [RU] Удлинитель
- [MK] Продолжеток

арт. № art. №	Размер Size (mm)	L (mm)	Баркод Barcode
330372	3/8" x 50	50	
330373	3/8" x 75	75	
330374	3/8" x 150	150	
330375	3/8" x 250	250	

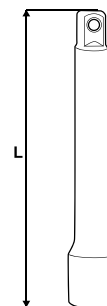





CR-V  
50BV30  
STEEL

3/8"



## WOBBLE EXTENSION BAR

- [BG] Удължение за работа под ъгъл • [RO] Adapter lung
- [EL] Κασάνιας προέκταση • [PT] Alongador • [IT] Bussola lunga
- [SR] Nastavak za nasadni ključ • [SL] Podaljšek gibljiv
- [BH] Produžetak za natikače • [RU] Удлинитель • [MK] Продолжеток

арт. № art. №	Размер Size (mm)	L (mm)	Баркод Barcode
330176	3/8" x 50	50	
330177	3/8" x 75	75	
330178	3/8" x 150	150	
330179	3/8" x 250	250	
330180	3/8" x 450	450	



2<sup>ND</sup>  
GENERATION

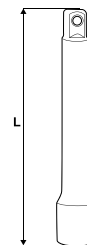

CR-V  
50BV30  
STEEL



DIN  
3123

3/8"



## ADAPTER

- [BG] Адаптер • [RO] Adapter • [EL] Καστάνιας αντάπτορας
- [PT] Adapter • [IT] Adattatore • [SR] Adapter za nasadni ključ
- [SL] Nastavek • [BH] Adapter • [RU] Переходник • [MK] Адаптер

Арт. № Art. №	Размер Size	L (mm)	Баркод Barcode
330377	3/8" F x 1/4" M	25	
330378	3/8" F x 1/2" M	36	

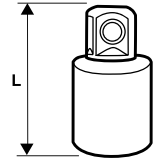

CR-V  
50BV30  
STEEL



DIN  
3123

3/8"



## ADAPTER

- [BG] Адаптер • [RO] Adapter • [EL] Καστάνιας αντάπτορας • [PT] Adapter • [IT] Adattatore
- [SR] Adapter za nasadni ključ • [SL] Nastavek • [BH] Adapter • [RU] Переходник • [MK] Адаптер

арт. № art. №	Размер Size	L (mm)	Баркод Barcode
330102	3/8" F x 1/4" M	25	
330101	3/8" F x 1/2" M	36	



30  
YEARS  
WARRANTY

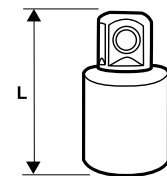



CR-V  
50BV30  
STEEL

DIN  
3123

3/8"

## 3-WAY SLIDING T-HEAD

- [BG] Адаптер с отвор за върток • [RO] Adapter • [EL] Μανέλας αντάπτορας • [PT] Adapter
- [IT] Adapter • [SR] Adapter za nasadni ključ • [SL] Nastavek za t ročico
- [BH] Adapter • [RU] Шарнир • [MK] Адаптер

арт. № art. №	Размер Size	L (mm)	Баркод Barcode
330437	3/8" F x 1/2" M	37	
330438	3/8" F x 1/4" M	26	



30  
YEARS  
WARRANTY

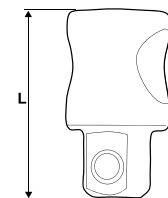

CR-V  
50BV30  
STEEL

DIN  
3123

3/8"

## SLIDING BAR - SATIN

- [BG] Върток подвижна "Т" - дръжка • [RO] Levier strangere satinat • [EL] Μανέλα ταφ • [PT] Chave T deslizante
- [IT] Leva di serraggio satinata • [SR] T nastavak za gedoru • [SL] Ročica \*T\* • [BH] Klizač • [RU] Вороток
- [MK] "Т" рачка со наставка

арт. № art. №	Размер Size	L (mm)	Баркод Barcode
330153	3/8"	200	

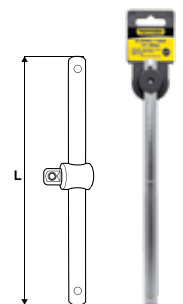

2<sup>ND</sup>  
GENERATION

30  
YEARS  
WARRANTY

Cr-V  
STEEL

DIN  
3122

3/8"

## UNIVERSAL JOINT

- [BG] Кардан • [RO] Cuplaj cardanic • [EL] Πολύσπαστο • [PT] Cardan
- [IT] Bussola tubolare flessibile • [SR] Nastavak za nasadni ključ zglobni
- [SL] Zglob kardanski • [BH] Natikač zglobni • [RU] Шарнир • [MK] Кардански зглоб

арт. № art. №	Размер Size	L (mm)	Баркод Barcode
330165	3/8"	56	



## RATCHET HANDLE EXTENSION

- [BG] Тресчотка с телескопична дръжка • [RO] Maner clichet extensibil • [EL] Καστάνια τηλεσκοπική
- [PT] Roquete • [IT] Chiave a cricchetto • [SR] Čegrtaljka • [SL] Raglja podaljševalna • [BH] Račna
- [RU] Трещотка С Телескопической Ручкой • [MK] Телескопска рачка со крцкало



арт. № art. №	Размер Size	L (mm)	Зъби Teeth	Баркод Barcode
336905	3/8"	230-330	72	



## RATCHET HANDLE

- [BG] Тресчотка • [RO] Maner clichet • [EL] Καστάνια • [PT] Roquete • [IT] Chiave a cricchetto
- [SR] Čegrtaljka • [SL] Račna • [BH] Račna • [RU] Трещотка • [MK] Рачка со крцкало



арт. № art. №	Размер Size	L (mm)	Зъби Teeth	Баркод Barcode
330168	3/8"	200	72	



## RATCHET HANDLE

- [BG] Тресчотка • [RO] Maner clichet • [EL] Καστάνια • [PT] Roquete • [IT] Chiave a cricchetto
- [SR] Čegrtaljka • [SL] Raglja • [BH] Račna • [RU] Трещотка • [MK] Рачка со крцкало





















арт. № art. №	Размер Size	Зъби Teeth	L (mm)	Баркод Barcode
336902	3/8"	72	210	



# HEXAGONAL SOCKET

- [BG] Вложка • [RO] Cheie tubulara • [EL] Καρυδάκι εξαγωνο κοτό • [PT] Chave de caixa • [IT] Bussola 6 punti • [SR] Nasadni ključ
- [SL] Šestkotni nasadni ključ • [BH] Natikač • [RU] Шестигранная сменная головка • [MK] Ключ насаден

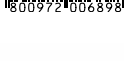

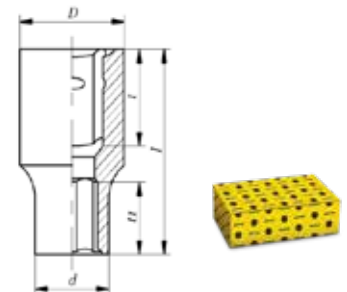















Art. № Art. №	Размер Size (mm)	D (mm)	d (mm)	l (mm)	t (mm)	t1 (mm)	MINIMUM TEST TORQUES (Nm)	Баркод Barcode
330379	1/2" x 8	21.8	13.7	38	16	5	120	
330381	1/2" x 9	21.8	14.2	38	16	5	130	
330382	1/2" x 10	21.8	15.3	38	16	6	147	
330383	1/2" x 11	21.8	16.5	38	16	7	178	
330384	1/2" x 12	21.8	17.8	38	16	8	212	
330385	1/2" x 13	21.8	19	38	16	8	249	
330386	1/2" x 14	21.8	20.3	38	16	10	288	
330387	1/2" x 15	20.5	21.8	38	16	10	331	
330388	1/2" x 16	20.5	21.8	38	16	10	377	
330389	1/2" x 17	21.8	23.8	38	16	10	425	
330403	1/2" x 18	22.8	25.8	38	16	12	477	
330404	1/2" x 19	22.8	25.8	38	16	12	531	
330405	1/2" x 21	23.8	27.8	38	16	12	569	
330406	1/2" x 22	26	29.8	38	16	14	569	
330407	1/2" x 23	28	31.8	39	16	14	569	
330408	1/2" x 24	28	31.8	39	16	16	569	
330409	1/2" x 27	30	35.8	42	16	18	569	
330410	1/2" x 30	34	39.8	44	16	20	569	
330489	1/2" x 32	36	41.8	44	16	22	569	





# HEXAGONAL SOCKET

- [BG] Вложка • [RO] Cheie tubulara • [EL] Καρυδάκι εξάγωνο κοντό • [PT] Chave de caixa • [IT] Bussola 6 punti • [SR] Nasadni ključ
- [SL] Šestkotni nasadni ključ • [BH] Natikač • [RU] Шестигранная сменная головка • [MK] Ключ насаден

Art. № Art. №	Размер Size (mm)	D (mm)	d (mm)	l (mm)	t (mm)	t' (mm)	MINIMUM TEST TORQUES (Nm)	Баркод Barcode
330461	1/2" x 8	22	13	38±1	16	5	120	
330462	1/2" x 9	22	14	38±1	16	5	130	
330463	1/2" x 10	22	15	38±1	16	6	147	
330464	1/2" x 11	22	16	38±1	16	7	178	
330465	1/2" x 12	22	17	38±1	16	8	212	
330466	1/2" x 13	22	19	38±1	16	8	249	
330467	1/2" x 14	22	20	38±1	16	10	288	
330468	1/2" x 15	21	21	38±1	16	10	331	
330469	1/2" x 16	21	22	38±1	16	10	377	
330470	1/2" x 17	22	24	38±1	16	10	425	
330471	1/2" x 18	23	25	38±1	16	12	477	
330472	1/2" x 19	23	26	38±1	16	12	531	
330473	1/2" x 21	24	28	38±1	16	12	569	
330474	1/2" x 22	24	30	38±1	16	14	569	
330475	1/2" x 24	30	32	38±1	16	16	569	
330476	1/2" x 27	30	36	42±1	16	18	569	
330477	1/2" x 30	30	40	44±1	16	20	569	
330478	1/2" x 32	30	42	44±1	16	22	569	



# BI - HEXAGONAL SOCKET

- [BG] Вложка 12 стенна • [RO] Cheie tubulara 12 colturi • [EL] Καρυδάκι 12γωνο • [PT] Chave caixa 12 faces
- [IT] Bussola 12 punti s • [SR] Nasadni ključ 12-ugaoni • [SL] Dvanajstkotni nasadni ključ
- [BH] Natikač • [RU] 12 Стенная смеанная головка • [MK] Ключ насаден

Art. № Art. №	Размер Size (mm)	D (mm)	d (mm)	l (mm)	t (mm)	t' (mm)	MINIMUM TEST TORQUES (Nm)	Баркод Barcode
330425	1/2" x 8	21.8	13.7	38	16	5	110	
330426	1/2" x 9	21.8	14.2	38	16	5	120	
330427	1/2" x 10	21.8	15.3	38	16	6	147(14.7)	
330428	1/2" x 11	21.8	16.5	38	16	7	178(17.8)	
330429	1/2" x 12	21.8	17.8	38	16	8	212(21.2)	
330430	1/2" x 13	21.8	19	38	16	8	249(24.9)	
330431	1/2" x 14	21.8	20.3	38	16	10	288(28.8)	
330432	1/2" x 15	20.5	21.8	38	16	10	331(33.1)	
330433	1/2" x 16	20.5	21.8	38	16	10	377(37.7)	
330434	1/2" x 17	21.8	23.8	38	16	10	425(42.5)	
330435	1/2" x 18	22.8	25.8	38	16	12	477(47.7)	
330454	1/2" x 19	22.8	25.8	38	16	12	531(53.1)	
330483	1/2" x 21	23.8	27.8	38	16	12	569(56.9)	
330484	1/2" x 22	26	29.8	38	16	14	569(56.9)	
330485	1/2" x 24	28	31.8	39	16	14	569(56.9)	
330486	1/2" x 27	30	35.8	42	16	18	569(56.9)	
330487	1/2" x 30	34	39.8	44	16	20	569(56.9)	
330488	1/2" x 32	36	41.8	44	16	22	569(56.9)	

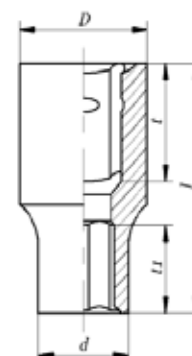

# BI - HEXAGONAL SOCKET

- [BG] Вложка 12 стенна • [RO] Cheie tubulara 12 colturi • [EL] Καρυδάκι 12γωνο • [PT] Chave caixa 12 faces
- [IT] Bussola 12 punti • [SR] Nasadni ključ 12-ugaoni • [SL] Dvanajstkotni nasadni ključ • [BH] Natikač
- [RU] 12 Стенная Сменная Головка • [MK] Ключ насаден

Art. № Art. №	Размер Size (mm)	D (mm)	d (mm)	l (mm)	t (mm)	t <sup>1</sup> (mm)	MINIMUM TEST TORQUES (Nm)	Баркод Barcode
------------------	---------------------	-----------	-----------	-----------	-----------	------------------------	------------------------------------	-------------------

330257	1/2" x 8	22	13	38±1	16	5	110	
330258	1/2" x 9	22	14	38±1	16	5	120	
330259	1/2" x 10	22	15	38±1	16	6	147	
330260	1/2" x 11	22	16	38±1	16	7	178	
330261	1/2" x 12	22	18	38±1	16	8	212	
330262	1/2" x 13	22	19	38±1	16	8	249	
330263	1/2" x 14	22	20	38±1	16	10	288	
330264	1/2" x 15	21	22	38±1	16	10	331	
330265	1/2" x 16	21	22	38±1	16	10	377	
330266	1/2" x 17	22	22	38±1	16	10	425	
330267	1/2" x 18	23	23	38±1	16	12	477	
330268	1/2" x 19	23	23	38±1	16	12	531	
330269	1/2" x 20	24	28	38±1	16	12	569	



330270	1/2" x 21	24	24	38±1	16	12	569	
330271	1/2" x 22	24	24	38±1	16	14	569	
330273	1/2" x 24	25	25	38±1	16	16	569	
330276	1/2" x 27	30	30	42±1	16	18	569	
330279	1/2" x 30	30	30	44±1	16	20	569	
330280	1/2" x 32	30	30	44±1	16	22	569	

# SOCKET E-TORX

- [BG] Вложка E - TORX • [RO] Tubulara • [EL] Καρυδάκι e-torx • [PT] Chave E-Torx • [IT] Bussola E
- [SR] Nasadni ključ • [SL] Nasadni ključ E-TORX • [BH] Natikač • [RU] Сменная головка E - Torx • [MK] Ключ насаден

art. № art. №	Размер Size (mm)	D (mm)	d (mm)	l (mm)	t (mm)	t <sup>1</sup> (mm)	Баркод Barcode
------------------	---------------------	-----------	-----------	-----------	-----------	------------------------	-------------------

331101	1/2" x 8	22	13	38	16	7.5	
331102	1/2" x 10	22	15	38	16	7.5	
331103	1/2" x 12	22	16	38	16	9	
331104	1/2" x 14	22	18	38	16	10	
331105	1/2" x 16	22	20	38	16	11	
331106	1/2" x 18	22	20	38	16	12.5	



331107	1/2" x 20	22	24	38	16	14	
331108	1/2" x 22	22	26	38	16	15	
331109	1/2" x 24	22	28	38	16	15	



# HEXAGONAL DEEP SOCKET NEW

- [BG] Вложка удължена • [RO] Cheie tubulara adanca
- [EL] Καρυδάκι εξαγώνο μακρύ • [PT] Chave caixa long
- [IT] Bussola profonda • [SR] Nasadni ključ produženi
- [SL] Šestkotni dolgi nasadni ključ • [BH] Natikač
- [RU] Удлиненная шестигранная головка
- [MK] Ключ насаден продолжен

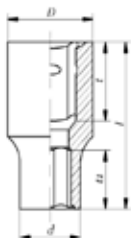

Art. № Art. №	Размер Size (mm)	D (mm)	d (mm)	l (mm)	t (mm)	t' (mm)	MINIMUM TEST TORQUES (Nm)	Баркод Barcode
330000	1/2" x 10	21.8	15.3	78	16	9	147	
330001	1/2" x 11	21.8	16.5	78	16	10.5	178	
330002	1/2" x 12	21.8	17.8	78	16	12	212	
330003	1/2" x 13	21.8	19	78	16	12	249	
330004	1/2" x 14	21.8	20.3	78	16	15	288	
330005	1/2" x 15	20.5	21.8	78	16	15	331	
330006	1/2" x 16	20.5	21.8	78	16	15	377	
330007	1/2" x 17	21.8	23.8	78	16	15	425	
330008	1/2" x 18	22.8	25.8	78	16	18	477	
330009	1/2" x 19	22.8	25.8	78	16	18	531	
330010	1/2" x 21	23.8	27.8	78	16	18	569	
330011	1/2" x 22	26	29.8	78	16	21	569	
330012	1/2" x 24	28	31.8	78	16	24	569	
330013	1/2" x 27	30	35.8	78	16	27	569	
330014	1/2" x 30	34	39.8	78	16	30	569	
330015	1/2" x 32	36	41.8	78	16	33	569	

# HEXAGONAL DEEP SOCKET



- [BG] Вложка удължена • [RO] Cheie tubulara adanca
- [EL] Καρυδάκι εξαγώνο μακρύ • [PT] Chave caixa long
- [IT] Bussola profonda • [SR] Nasadni ključ produženi
- [SL] Šestkotni dolgi nasadni ključ • [BH] Natikač
- [RU] Удлиненная шестигранная головка
- [MK] Ключ насаден продолжен

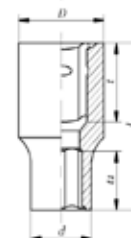

Art. № Art. №	Размер Size (mm)	D (mm)	d (mm)	l (mm)	t (mm)	t' (mm)	MINIMUM TEST TORQUES (Nm)	Баркод Barcode
330127	1/2" x 10	22	15	38±1	16	6	147	
330128	1/2" x 11	22	16	38±1	16	7	178	
330129	1/2" x 12	22	18	38±1	16	8	212	
330130	1/2" x 13	22	19	38±1	16	12	249	
330131	1/2" x 14	22	20	38±1	16	15	288	
330132	1/2" x 15	21	22	38±1	16	15	331	
330133	1/2" x 16	21	22	38±1	16	15	377	
330134	1/2" x 17	22	24	38±1	16	15	425	
330135	1/2" x 18	23	25	38±1	16	18	477	
330136	1/2" x 19	23	26	38±1	16	18	531	
330137	1/2" x 20	24	24	38±1	16	18	569	
330138	1/2" x 21	24	24	38±1	16	18	569	
330139	1/2" x 22	24	24	38±1	16	21	569	
330141	1/2" x 24	25	25	38±1	16	24	569	
330144	1/2" x 27	30	30	38±1	27	569		
330145	1/2" x 30	30	30	42±1	16	30	569	
330146	1/2" x 32	30	30	44±1	16	33	569	

## BI - HEXAGONAL DEEP SOCKET

- [BG] Вложка удължена 12 стенна • [RO] Cheie tubulara adanca 12 colturi • [EL] Καρυδάκι 12γωνο μακρύ • [PT] Chave caixa longa 12 faces
- [IT] Bussola profonda 12 punti • [SR] Nasadni ključ produženi 12-ugaoni • [SL] Dvanajstkotni dolgi nasadni ključ • [BH] Natikač
- [RU] 12 стенная смеанная шести гранная головка • [MK] Ключ насаден продолжен



арт. № art. №	Размер Size (mm)	D (mm)	d (mm)	l (mm)	t (mm)	t <sup>1</sup> (mm)	MINIMUM TEST TORQUES (Nm)	Баркод Barcode
330326	1/2" x 10	22	15	77	16	6	147	
330327	1/2" x 11	22	16	77	16	7	178	
330328	1/2" x 12	22	18	77	16	8	212	
330329	1/2" x 13	22	19	77	16	12	249	
330330	1/2" x 14	22	20	77	16	15	288	
330331	1/2" x 16	21	22	77	16	15	377	
330332	1/2" x 17	22	24	77	16	15	425	
330333	1/2" x 18	23	25	77	16	18	477	
330334	1/2" x 19	23	26	77	16	18	531	
330335	1/2" x 21	24	28	77	16	18	569	
330336	1/2" x 22	24	30	77	16	21	569	
330337	1/2" x 24	25	32	77	16	24	569	
330338	1/2" x 27	30	36	77	16	27	569	
330339	1/2" x 30	30	40	77	16	30	569	
330340	1/2" x 32	30	42	77	16	33	569	



## SLOTTED BIT SOCKET



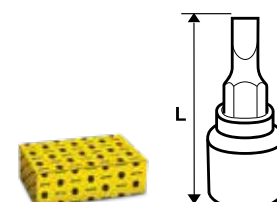

- [BG] Вложка с накрайник • [RO] Bit tubulara ST • [EL] Μύτη καταβίδι ίσιο καρυδάκι • [PT] Chave Bits • [IT] Bussola Bit
- [SR] Nastavak na gedori pljosnati • [SL] Nastavek ploščati • [BH] Bit • [RU] Головка с наконечником • [MK] Ключ насаден заштрафувач

арт. № art. №	Размер Size		L (mm)	Баркод Barcode
330292	1/2"	8	55	
330293	1/2"	12	55	
330294	1/2"	16	55	



## PHILLIPS BIT SOCKET

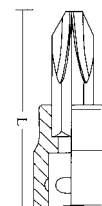

- [BG] Вложка с накрайник • [RO] Bit tubulara PH • [EL] Μύτη καθαβίδι σταυρός καρυδάκι • [PT] Chave Bits • [IT] Bussola Bit
- [SR] Nastavak na gedori PZ • [SL] Nastavek križni • [BH] Bit • [RU] Головка С Наконечником • [MK] Ключ насаден зашрафувач

арт. № art. №	Размер Size		L (mm)	Баркод Barcode
330288	1/2"	PH1	55	
330289	1/2"	PH2	55	
330290	1/2"	PH3	55	
330291	1/2"	PH4	55	



## SPARK PLUG SOCKET WITH MAGNET

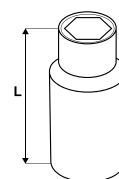

- [BG] Вложка за свеци с магнит • [RO] Cheie tubulara magnetica bujii • [EL] Καρυδάκι εξαγωγή μακρύ για μπουζί • [PT] Chave de vela magnética
- [IT] Bussola per candele 6 punti • [SR] Nasadni ključ magnetni • [SL] Ključ za svečke • [BH] Natikač za svjećicu magnetni
- [RU] Сменная свечная головка с магнитом • [MK] Насаден клуч за свеќици

арт. № art. №	Размер Size (mm)	L (mm)	Баркод Barcode
330451	1/2" x 16	70	
330452	1/2" x 21	70	



## SPARK PLUG SOCKET

- [BG] Вложка за свеци • [RO] Cheie tubulara bujii • [EL] Καρυδάκι εξαγωγή μακρύ για μπουζί
- [PT] Chave de vela • [IT] Bussola satinata • [SR] Nasadni ključ za svečice
- [SL] Ključ za svečke • [BH] Natikač za svjećicu
- [RU] Сменная Свечная Головка
- [MK] Насаден клуч за свеќици

арт. № art. №	Размер Size (mm)	L (mm)	Баркод Barcode
331005	1/2" x 16	70	
331006	1/2" x 19	70	
331007	1/2" x 21	70	

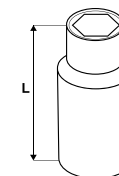



## BI-HEXAGONAL SPARK PLUG SOCKET WITH MAGNET

- [BG] Вложка за свещи с магнит 12-стенна • [RO] Tubulara pt. Bujii 12 pct magnetica CR-V • [EL] Καρυδάκι εξαγώνο μακρό για μπουζί
- [PT] Chave de vela magnética • [IT] Bussola per candele 6 punti • [SR] Nasadni ključ magnetni • [SL] Ključ za svečke
- [BH] Natikač za svjećicu magnetni • [RU] Сменная свечная головка с магнитом • [MK] Насаден клуч за свеќици

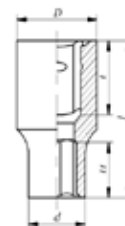

арт. № art. №	Размер Size (mm)	L (mm)	Баркод Barcode
330453	1/2" x 21 mm	70	



## EXTENSION BAR

- [BG] Удължение • [RO] Adapter lung • [EL] Κασάνιας προέκταση • [PT] Alongador
- [IT] Bussola lunga • [SR] Nastavak za nasadni ključ • [SL] Nastavek za nasadni ključ
- [BH] Produžetak za natikače • [RU] Удлинитель • [MK] Пролонжеток

арт. № art. №	Размер Size (mm)	L (mm)	Баркод Barcode
330016	1/2" x 50	75	
330017	1/2" x 125	125	
330018	1/2" x 250	250	

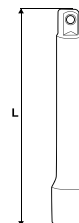

## WOBBLE EXTENSION BAR

- [BG] Удължение за работа под ъгъл • [RO] Adapter lung
- [EL] Κασάνιας προέκταση με δυνατότητα κλίσης • [PT] Alongador
- [IT] Bussola lunga • [SR] Nastavek za nasadni ključ • [SL] Podaljšek gibljiv
- [BH] Produžetak za natikače • [RU] Удлинитель • [MK] Пролонжеток

арт. № art. №	Размер Size (mm)	L (mm)	Баркод Barcode
330181	1/2" x 50	50	
330182	1/2" x 125	125	
330183	1/2" x 250	250	
330184	1/2" x 500	500	

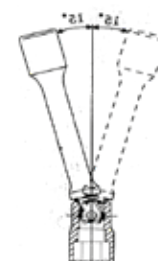

## ADAPTER

- [BG] Адаптер • [RO] Adapter • [EL] Καστάνιας αντάπτορας • [PT] Adapter
- [IT] Adattatore • [SR] Adapter za nasadni ključ • [SL] Natavek • [BH] Adapter
- [RU] Переходник • [MK] Адаптер

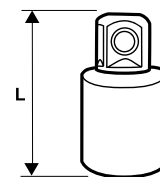



арт. № art. №	Размер Size	L (mm)	Баркод Barcode
330020	1/2" F x 3/8" M	43	

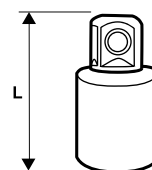

## ADAPTER

- [BG] Адаптер • [RO] Adapter • [EL] Καστάνιας αντάπτορας
- [PT] Adapter • [IT] Adattatore • [SR] Adapter za nasadni ključ
- [SL] Natavek • [BH] Adapter • [RU] Переходник • [MK] Адаптер





арт. № art. №	Размер Size	L (mm)	Баркод Barcode
330104	1/2" F x 3/8" M	43	
330103	1/2" F x 3/4" M	43	

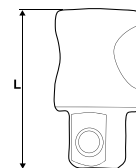

## ADAPTER

- [BG] Адаптер с отвор за върток • [RO] Adapter
- [EL] Μανέλας αντάπτορας • [PT] Adapter • [IT] Adattatore
- [SR] Adapter za nasadni ključ • [SL] Nastavek za t ročico • [BH] Adapter
- [RU] Переходник • [MK] Адаптер



арт. № art. №	Размер Size	L (mm)	Баркод Barcode
330436	1/2" F x 3/8" M	27	



## BIT ADAPTER

- [BG] Адаптер за накрайници • [RO] Adapter biti
- [EL] Αντάπτορας μύτης για καστάνια • [PT] Adapter • [IT] Adattatore Bit
- [SR] Adapter za nasadni ključ • [SL] Bit Natavek • [BH] Bit adapter
- [RU] Переходник • [MK] Адаптер за битови





арт. № art. №	Размер Size	Баркод Barcode
330368	1/2" (F) x 10 mm (F)	



## FLEX HANDLE

- [BG] Върток чупещ • [RO] Maner de forta flexibil • [EL] Μανέλα ρυθμιζόμενη • [PT] Chave articulada • [IT] Manico tubolare
- [SR] Ručica za gedoru sa zglobom • [SL] Ročaj z zglobom • [BH] Račna mehaničarska
- [RU] Вороток • [MK] Рачка со зглоб тип L

арт. № art. №	Размер Size	L (mm)	Баркод Barcode
330323	1/2"	380	 3 800123 120398
336910	1/2"	450	 3 800972 001176

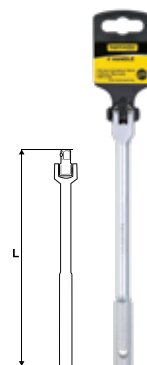

## L- TYPE HANDLE

- [BG] Върток Г – образен • [RO] Maner de forta tip L • [EL] Μανέλα γωνιακή • [PT] Chave L
- [IT] Manico tubolare tipo "L" • [SR] L nastavak za gedoru • [SL] Ročaj "L" • [BH] klizač
- [RU] Г - Образный Вороток • [MK] Рачка со зглоб тип "L"

арт. № art. №	Размер Size	L (mm)	Баркод Barcode
330022	1/2"	250	 3 800972 007307

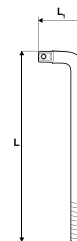

## L- TYPE HANDLE

- [BG] Върток Г – образен • [RO] Maner de forta tip L • [EL] Μανέλα γωνιακή • [PT] Chave L
- [IT] Manico tubolare tipo "L" • [SR] L nastavak za gedoru • [SL] Ročaj "L" • [BH] klizač
- [RU] Г - Образный Вороток • [MK] Рачка со зглоб тип "L"

арт. № art. №	Размер Size	L (mm)	Баркод Barcode
330296	1/2"	250	 3 800123 145933



## L- TYPE HANDLE

- [BG] Върток Г – образен • [RO] Maner de forta tip L • [EL] Μανέλα γωνιακή • [PT] Chave L • [IT] Manico tubolare tipo "L"
- [SR] L nastavak za gedoru • [SL] Ročaj "L" • [BH] klizač • [RU] Г - Образный Вороток
- [MK] Рачка со зглоб тип "L"

арт. № art. №	Размер Size	L (mm)	Баркод Barcode
330297	1/2"	315	 3 800123 145940

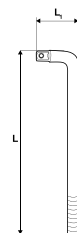

## SLIDING T BAR

- [BG] Върток подвижна "Т"- дръжка със заключване • [RO] Levier strangere • [EL] Μανελα ταφ
- [PT] Chave T deslizante • [IT] Manico tubolare • [SR] T nastavak za gedoru • [SL] Drsna ročica "T"
- [BH] Klizač • [RU] Вороток • [MK] "Т" рачка со наставак



арт. № art. №	Размер Size (mm)	L (mm)	Баркод Barcode
330344	1/2"	300	

- Бутон за задържане и освобождаване на вложките  
- Push Button

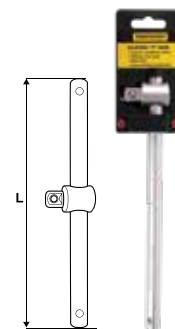

## SLIDING T BAR

- [BG] Върток подвижна "Т"- дръжк • [RO] Levier strangere • [EL] Μανελα ταφ • [PT] Chave T deslizante • [IT] Leva di serraggio satinata "T"
- [SR] T nastavak za gedoru • [SL] Drsna ročica "T" • [BH] Klizač • [RU] Вороток • [MK] Рачка со зглоб тип Т



арт. № art. №	Размер Size	L (mm)	Баркод Barcode
330154	1/2"	250	
330155	1/2"	300	

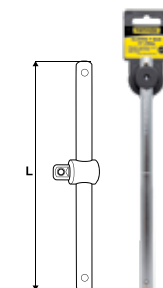

## UNIVERSAL JOINT

- [BG] Кардан • [RO] Cuplaj cardanic • [EL] Πολύπαστο • [PT] Cardan
- [IT] Bussola tubolare flessibile • [SR] Nastavak za nasadni ključ zglobni
- [SL] Zglob kardanski • [BH] Natikač zglobni • [RU] Шарнир • [MK] Кардански зглоб

арт. № art. №	Размер Size	L (mm)	Баркод Barcode
330166	1/2"	72	

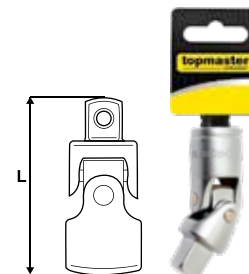



## TWISTER RATCHET HANDLE

- [BG] Тресчотка с въртяща дръжка • [RO] Cheie clichet cu maner rotativ • [EL] Καστάνια • [PT] Roquete
- [IT] Cricchetto a manico rotante • [SR] Čegrtaljka • [SL] Račna z vrtljivo ročico • [BH] Račna • [RU] Тресчотка
- [MK] Двонасочна крцкалка со вртлива рачка



арт. № art. №	Размер Size	L (mm)	Зъби Teeth	Баркод Barcode
336702	1/2"	290	60	 3 80012311626951



## RATCHET HANDLE EXTENSION

- [BG] Тресчотка с телескопична дръжка • [RO] Maner clichet extensibil • [EL] Καστάνια τηλεσκοπική • [PT] Roquete
- [IT] Cricchetto con manico • [SR] Čegrtaljka • [SL] Račna podaljševalna • [BH] Račna • [RU] Тресчотка с телескопичной ручкой
- [MK] Телескопска рачка со крцкало



арт. № art. №	Размер Size	L (mm)	Зъби Teeth	Баркод Barcode
336904	1/2"	300-445	72	 3 800972 001114



## RATCHET HANDLE EXTENSION

- [BG] Тресчотка с телескопична дръжка • [RO] Maner clichet extensibil • [EL] Καστάνια αρθρωτή τηλεσκοπική
- [PT] Roquete • [IT] Cricchetto con manico • [SR] Čegrtaljka • [SL] Račna podaljševalna • [BH] Račna
- [RU] Тресчотка с телескопичной ручкой • [MK] Телескопска рачка со крцкало



арт. № art. №	Размер Size	L (mm)	Зъби Teeth	Баркод Barcode
336907	1/2"	340-475	72	 3 800972 001145



## SLIM RATCHET HANDLE

- [BG] Тресчотка • [RO] Maner clichet • [EL] Καστάνια
- [PT] Roquete • [IT] Cricchetto con manico • [SR] Čegrtaljka • [SL] Račna • [BH] Račna
- [RU] Тресчотка • [MK] Рачка со крцкало

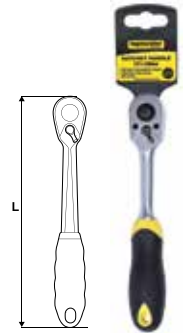

арт. № art. №	Размер Size	L (mm)	Зъби Teeth	Баркод Barcode
330341	1/2"	260	48	



## RATCHET HANDLE

- [BG] Тресчотка • [RO] Maner clichet • [EL] Καστάνια • [PT] Roquete • [IT] Cricchetto con manico
- [SR] Čegrtaljka • [SL] Račna • [BH] Račna • [RU] Тресчотка • [MK] Рачка со крцкало



арт. № art. №	Размер Size	L (mm)	Зъби Teeth	Баркод Barcode
336901	1/2"	250	72	



## RATCHET HANDLE

- [BG] Тресчотка • [RO] Maner clichet • [EL] Καστάνια • [PT] Roquete • [IT] Cricchetto con manico
- [SR] Čegrtaljka • [SL] Račna • [BH] Račna • [RU] Тресчотка • [MK] Рачка со крцкало



арт. № art. №	Размер Size	L (mm)	Зъби Teeth	Баркод Barcode
330170	1/2"	255	72	



## SPLIN SOCKET SET

- [BG] Вложки Splin • [RO] Set tubulare spline • [EL] карубакта сѐт splin • [PT] Jogo 12 chaves
- [IT] Kit bussole aldrive 12 pezzi • [SR] Nasadni ključevi 12-ugaoni na šini • [SL] Nastavki na obešalu.
- [BH] Natikač set • [RU] Набор сменных головок • [MK] Гарнитура насадни клучеви



Sizes: 10, 11, 12, 13, 14, 16, 17, 19, 21, 22, 24 mm



арт. № art. №	Размер Size (mm)	Броя в компл. Pcs/Set	Баркод Barcode
330320	1/2"	12	



## STAR SOCKET SET

- [BG] Вложки E - TORX комплект • [RO] Set tubulare E-Torx • [EL] Карубакта star сѐт • [PT] Jogo 9 chaves torx • [IT] Kit bussole
- [SR] Nasadni ključevi TORX na šini • [SL] Nastavki TORX • [BH] Natikač set • [RU] Набор сменных E - Torx головок
- [MK] Гарнитура насадни клучеви



E10, E11, E12, E14, E16, E18, E20, E22, E24



арт. № art. №	Размер Size (mm)	Броя в компл. Pcs/Set	Баркод Barcode
330150	1/2"	9	





## HEXAGONAL SOCKET

- [BG] Вложка • [RO] Tubulara • [EL] Καρυδάκι εξαγώνο • [PT] Chave de caixa • [IT] Bussola
- [SR] Nasadni ključ • [SL] Šestkotni nasadni ključ • [BH] Natikač šestougaoni
- [RU] Сменная головка • [MK] Насаден клуч

арт. № art. №	Размер Size (mm)	D (mm)	d (mm)	l (mm)	t (mm)	t' (mm)	MINIMUM TEST TORQUES (Nm)	Баркод Barcode
330225	3/4" x 22	36	32	50	25	13	569	
330227	3/4" x 24	36	34	50	25	14	569	
330230	3/4" x 27	36	38	52	25	16	665	
330233	3/4" x 30	38	42	54	25	17	795	
330234	3/4" x 32	38	44	56	25	20	888	
330237	3/4" x 35	42	48	58	25	22	984	
330238	3/4" x 36	42	50	58	25	22	1084	
330241	3/4" x 41	45	56	64	25	26	1432	

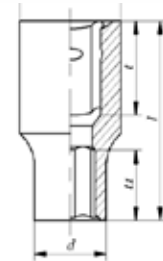

## BI - HEXAGONAL SOCKET

- [BG] Вложка 12 стена • [RO] Cheie tubulara 12 colturi • [EL] Καρυδάκι 12γωνο • [PT] Chave caixa 12 faces
- [IT] Bussola 12 punti • [SR] Nasadni ključ 12-ugaoni • [SL] Dvanajstkotni nasadni ključ • [BH] Natikač
- [RU] 12 Стенная Сменная Головка • [MK] Клуч насаден

арт. № art. №	Размер Size (mm)	D (mm)	d (mm)	l (mm)	t (mm)	t' (mm)	MINIMUM TEST TORQUES (Nm)	Баркод Barcode
337600	3/4" x 22	36	33	50	24	14	569	
337601	3/4" x 24	36	34	50	24	16	569	
337602	3/4" x 27	36	38	52	24	18	665	
337603	3/4" x 30	38	42	54	24	20	795	
337604	3/4" x 32	38	44	56	24	22	888	
337605	3/4" x 35	42	48	56	24	22	984	
337606	3/4" x 36	42	50	58	24	24	1084	
337607	3/4" x 41	48	56	64	24	27	1432	
337608	3/4" X 46	48	62	66	24	30	1650	
337609	3/4" X 55	54	74	77	24	36	1720	

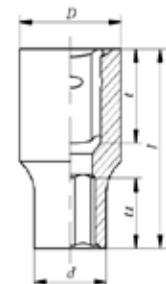



## EXTENSION BAR

- [BG] Удължение • [RO] Adapter lung
- [EL] Κασάνιας προέκταση • [PT] Alongador • [IT] Bussola lunga
- [SR] Nastavak za nasadni ključ • [SL] Podaljšek
- [BH] Produžetak za natikače • [RU] Удлинитель
- [MK] Продолжеток

арт. №  
art. №

Размер  
Size

L  
(mm)

Баркод  
Barcode

335902 3/4" 200

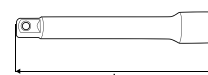

CR-V  
50BV30  
STEEL

DIN  
3123

3/4"

## ADAPTER

- [BG] Адаптер • [RO] Adapter • [EL] Κασάνιας αντάπτορας • [PT] Adapter • [IT] Adattore • [SR] Adapter za nastavk
- [SL] Adapter • [BH] Natavek • [RU] Переходник • [MK] Адаптер

арт. №  
art. №

Размер  
Size

Баркод  
Barcode

330105 3/4"F x 1/2"(M)



330369 3/4"(F) x 1"(M)



330370 1"F x 3/4"(M)

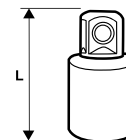

CR-V  
50BV30  
STEEL

DIN  
3123

1/2"

3/4"

1"

## L- TYPE HANDLE

- [BG] Върток Г – образен • [RO] Maner de forta "L" • [EL] Μανέλα γωνιακή • [PT] Chave T deslizante
- [IT] Manico tubolare tipo "L" • [SR] L nastavak za gedoru • [SL] Ročica \*L\* • [BH] Klizač • [RU] Г - Образный вороток
- [MK] Рачка тип L

арт. №  
art. №

Размер  
Size

L  
(mm)

Баркод  
Barcode

331702 3/4" 450

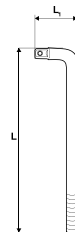

Cr-V  
STEEL

3/4"

## SLIDING T BAR

- [BG] Върток подвижна "Т"- дръж • [RO] Levier strangere • [EL] Μανέλα ταφ • [PT] Chave T deslizante • [IT] Manico tubolare
- [SR] T nastavak za gedoru • [SL] Drsna ročica \*T\* • [BH] Klizač • [RU] Вороток с Г - образной ручкой
- [MK] Рачка со зглоб тип Т

арт. №  
art. №

Размер  
Size

L  
(mm)

Баркод  
Barcode

331701 3/4" 500

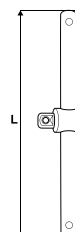

Cr-V  
STEEL

DIN  
3122

3/4"

## RATCHET HANDLE

- [BG] Тресчотка • [RO] Maner clichet • [EL] Κασάνια • [PT] Roquete • [IT] Cricchetto • [SR] Čegrtaljka • [SL] Račna
- [BH] Račna • [RU] Тресчотка • [MK] Рачка со крчкало

арт. №  
art. №

Размер  
Size

L  
(mm)

Зъби  
Teeth

Баркод  
Barcode

330380 3/4" 500 24



Cr-V  
STEEL

DIN  
3122

24

3/4"

# HEXAGONAL IMPACT SOCKET

- [BG] Вложка ударна • [RO] Cheie tubulara de impact • [EL] Καρυδάκι εξάγωνο κρουστικό • [PT] Chave impacto • [IT] Bussola ad impatto
- [SR] Nasadni ključ udarni kovani • [SL] Šestkotni IMPACT nasadni ključ • [BH] Natikač • [RU] Ударная Головка • [MK] Ударен насаден клуч

арт. № art. №	Размер Size (mm)	D (mm)	d (mm)	l (mm)	t (mm)	t <sup>1</sup> (mm)	MINIMUM TEST TORQUES (Nm)	Баркод Barcode
330345	1/2" x 10	24.8	17.5	38	16	4.2	147	
330593	1/2" x 11	24.8	18	38	16	4.9	178	
330594	1/2" x 12	24.8	19	38	16	5.6	212	
330595	1/2" x 13	24.8	20	38	16	5.6	249	
330596	1/2" x 14	24.8	22	38	16	7	288	
330597	1/2" x 15	24.8	23	38	16	7	331	
330346	1/2" x 16	24.8	24	38	16	7	377	
330201	1/2" x 17	29.8	26	38	16	7	425	
330200	1/2" x 18	29.8	27	38	16	8.4	477	
330202	1/2" x 19	29.8	28	38	16	8.4	531	
330203	1/2" x 21	29.8	29.8	38	16	9.8	569	

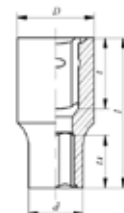

330347	1/2" x 22	30	31.8	38	16	9.8	569	
330205	1/2" x 24	30	33.8	40	16	11.2	569	
330206	1/2" x 27	30	37.8	42	16	12.6	569	
330207	1/2" x 30	30.5	41.8	44	16	14	569	
330208	1/2" x 32	32.5	43.8	44	16	15.4	569	

# HEXAGONAL DEEP IMPACT SOCKET

- [BG] Вложка удължена ударна • [RO] Cheie tubulara impact adanca • [EL] Καρυδάκι εξάγωνο κρουστικό μακρύ • [PT] Chave impacto longa
- [IT] Bussola ad impatto profonda • [SR] Nasadni ključ udarni kovani produženi • [SL] Šestkotni dolgi IMPACT nasadni ključ
- [BH] Natikač • [RU] Удлиненная Ударная Головка • [MK] Ударен насаден клуч , дол

арт. № art. №	Размер Size (mm)	D (mm)	d (mm)	l (mm)	t (mm)	t <sup>1</sup> (mm)	MINIMUM TEST TORQUES (Nm)	Баркод Barcode
330600	1/2" x 10	24.8	17.5	78	16	4.2	147	
330601	1/2" x 11	24.8	18	78	16	4.9	178	
330602	1/2" x 12	24.8	19	78	16	5.6	212	
330603	1/2" x 13	24.8	20	78	16	5.6	249	
330604	1/2" x 14	24.8	22	78	16	7	288	
330605	1/2" x 15	24.8	23	78	16	7	331	
330606	1/2" x 16	24.8	24	78	16	7	377	
330209	1/2" x 17	29.8	26	78	16	7	425	
330607	1/2" x 18	29.8	27	78	16	8.4	477	
330210	1/2" x 19	29.8	28	78	16	8.4	531	
330211	1/2" x 21	29.8	29.8	78	16	9.8	569	

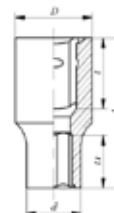

330212	1/2" x 24	30	33.8	78	16	11.2	569	
330608	1/2" x 27	30	37.8	78	16	13.6	569	
330609	1/2" x 30	30.5	41.8	78	16	14	569	
330610	1/2" x 32	32.5	43.8	78	16	15.4	569	

## IMPACT UNIVERSAL JOINT

- [BG] Кардан ударен • [RO] Cuplaj cardanic impact • [EL] Πολύσπαστο κρουστικό
- [PT] Cardan impacto • [IT] Bussola tubolare flessibile impatto
- [SR] Zglobni kovani nastavak • [SL] Zglob kardanski
- [BH] Natikač zglobni • [RU] Ударный шарнир
- [MK] Кардански зглоб

арт. № art. №	Размер Size	L (mm)	Баркод Barcode
330221	1/2"	72	



CR-Mo STEEL DIN 3121 1/2"

## IMPACT ADAPTER

- [BG] Адаптер ударен • [RO] Adapter Impact • [EL] Κασάνιας αντάπτορας
- [PT] Adapter • [IT] Adattatore • [SR] Adapter za nastavk • [SL] Adapter
- [BH] Natavek • [RU] Переходник • [MK] Адаптер

арт. № art. №	Размер Size	L (mm)	Баркод Barcode
337700	1/2"Fx3/4"M	58	



CR-Mo STEEL 1/2" 3/4"

## HEXAGONAL IMPACT SOCKET

- [BG] Вложка ударна • [RO] Cheie tubulara impact • [EL] Καρυδάκι εξαγώνο κρουστικό κοντό • [PT] Chave de impacto • [IT] Bussola ad impatto
- [SR] Nasadni ključ udarni kovani • [SL] Šestkotni IMPACT nasadni ključ • [BH] Natikač • [RU] Ударная головка • [MK] Ударен насаден клуч

арт. № art. №	Размер Size (mm)	D (mm)	d (mm)	l (mm)	t (mm)	t' (mm)	Баркод Barcode
330618	3/4" x 17	44	30	53	24	7	
330611	3/4" x 19	44	33	53	24	8.4	
330612	3/4" x 21	44	35	53	24	9.8	
330690	3/4" x 22	44	36	53	24	9.8	
330250*	3/4" x 22	44	36	50	25	9.8	
330613	3/4" x 24	44	38	53	24	11.2	
330693	3/4" x 27	44	41	53	24	12.6	
330691	3/4" x 30	44	46	53	24	14	
330253*	3/4" x 30	44	46	53	25	14	
330623	3/4" x 32	44	48	57	24	15.4	
330614	3/4" x 33	44	50	57	24	15.4	
330692	3/4" x 36	44	53	57	24	16.8	
330616	3/4" x 38	44	56	57	24	18.9	
330617	3/4" x 41	44	59	58	24	18.9	
330622	3/4" x 46	44	66	62	24	21	

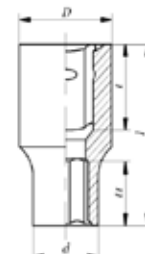

CR-Mo STEEL DIN 3129 3/4"

\* Артикулът е с хенгер

330624	3/4" x 50	54	71	65	24	23.1	
330625	3/4" x 52	54	74	68	24	25.2	
330626	3/4" x 57	54	79	70	24	27.3	

## IMPACT UNIVERSAL JOINT

- [BG] Кардан ударен • [RO] Cuplaj cardanic impact
- [EL] Πολύσπαστο κρουστικό • [PT] Cardan impacto
- [IT] Bussola tubolare flessibile impatto
- [SR] Zglobni kovani nastavak • [SL] Zglob kardanski IMPACT
- [BH] Natikač zglobni • [RU] Ударный шарнир
- [MK] Кардански зглоб

арт. № art. №	Размер Size	Баркод Barcode
330647	3/4"	



## IMPACT ADAPTER









- [BG] Адаптер ударен • [RO] Adapter Impact • [EL] Κασάνιας αντάπτορας • [PT] Adapter • [IT] Adattatore
- [SR] Adapter za nastavak • [SL] Adapter • [BH] Natavek • [RU] Переходник • [MK] Адаптер

арт. № art. №	Размер Size	Баркод Barcode
330646	3/4"Fx 1/2"М	
337703	1"Fx 3/4"М	



## HEXAGONAL DEEP IMPACT SOCKET

- [BG] Вложка ударна удължена • [RO] Cheie tubulara adanca impact • [EL] Καρυδάκι εξάγωνο κρουστικό • [PT] Chave impacto
- [IT] Bussola ad impatto • [SR] Nasadni ključ udarni kovani produženi • [SL] Šestkotni IMPACT nasadni ključ • [BH] Natikač
- [RU] Ударная сменная головка • [MK] Ударен насаден клуч, долг

арт. № art. №	Размер Size (mm)	D (mm)	d (mm)	l (mm)	t (mm)	t <sup>1</sup> (mm)	Баркод Barcode
335801	1" x 24	54	42	90	29	11.2	
335802	1" x 27	54	46	90	29	12.6	
335803	1" x 30	54	49	90	29	14	
335804	1" x 32	54	52	90	29	15.4	
335806	1" x 33	54	54	90	29	15.4	
335805	1" x 36	54	56	92	29	16.8	
330670	1" x 38	54	58	92	29	18.9	
330671	1" x 46	54	68	95	29	21	
330672	1" x 50	54	73	95	29	23.1	

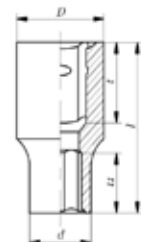



## TORX IMPACT BIT SOCKET SET

- [BG] Вложки ударни с накрайник TORX комплект • [RO] Socket Bit Impact • [EL] Καρυδακια κρουστικά με μπη torx • [PT] Soquete de broca de impacto • [IT] Socket Bit di impatto • [SR] Накрајници вложки • [SL] Vtičnica za udarce
- [BH] Set udarnih natikača torx • [RU] Набор Ударных Сменных Торх Головок
- [MK]

**T30, T40, T45, T50,  
T55, T60, T70, T80**



арт. № art. №	Размер Size	Баркод Barcode
338800	1/2"	 3 800972 4012608



## IMPACT BIT SOCKET SET

- [BG] Вложки ударни с накрайник шестограм комплект
- [RO] Socket Bit Impact • [EL] Καρυδακια κρουστικά με μπη αλλεν
- [PT] Soquete de broca de impacto • [IT] Socket Bit di impatto
- [SR] Накрајници вложки • [SL] Vtičnica za udarce • [BH] Set udarnih natikača • [RU] Набор Ударных Сменных Головок С Шестигранным Наконечником • [MK]

**H6, H7, H8, H10,  
H12, H14, H17, H19**



арт. № art. №	Размер Size	Баркод Barcode
338801	1/2"	 3 800972 4012691



## IMPACT DEEP SOCKET SET

- [BG] Вложки ударни удължени комплект
- [RO] Cheie tubulara impact adanca • [EL] Καρυδακια κρουστικα μακρια • [PT] Soquete profundo do impacto
- [IT] Bussola ad impatto profonda • [SR] Nasadni ključ udarni kovani produženi • [SL] Šestkotni dolgi impact nasadni ključ • [BH] Set dubokih udarnih natikača
- [RU] Набор Ударных Удлиненных Сменных Головок
- [MK]

**10, 12, 13, 14, 15,  
17, 19, 21, 22, 24 mm**



арт. № art. №	Размер Size	Баркод Barcode
338803	1/2"	



## IMPACT DEEP SOCKET SET

- [BG] Вложки ударни удължени комплект • [RO] Cheie tubulara impact adanca • [EL] Καρυδακια κρουστικα μακρια • [PT] Soquete profundo do impacto
- [IT] Bussola ad impatto profonda • [SR] Nasadni ključ udarni kovani produženi • [SL] Šestkotni dolgi impact nasadni ključ • [BH] Set dubokih udarnih natikača
- [RU] Большой Набор Ударных Удлиненных Сменных Головок
- [MK]

**10, 11, 12, 13, 14,  
15, 16, 17, 18, 19, 21,  
24, 27, 30, 32 mm**



арт. № art. №	Размер Size	Баркод Barcode
338802	1/2"	



# SOCKET SET

- [BG] Комплект инструменти • [RO] Trusa chei tubulare • [EL] Κασέτινα καρυδάκια • [PT] Jogo • [IT] Kit bussole • [SR] Set nasadnih ključeva
- [SL] Garnitura v kovčku • [BH] Set gedora • [RU] Набор Сменных Головок • [MK] Сет алати



14 бр. 1/4" Вложки  
14 units 1/4" Dr. Sockets  
14 buc 1/4" Tubulare

4, 4.5, 5, 5.5, 6,  
6.5, 7, 8, 9, 10,  
11, 12, 13, 14 mm



5 бр. 1/4" Удължени Вложки  
5 units 1/4" Dr. Deep Sockets  
5 buc 1/4" Lunga Tubulare

8, 10, 11, 12, 13 mm



Подвижна Свързка  
Universal Joint  
Adapter Tubulare Flexibil

1/4" DR.

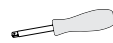

Върток  
Spinner Handle  
Maner ptr Tubulare

1/4" DR.



Върток Т-образен  
Sliding T-bar  
Levier Strangere Satin

1/4" DR.



Удължител 2 броя  
2 Units Extension Bar  
Adapter Lung 2 buc

1/4" DR. x 50, 100 mm



Тресчотка 45 зъба  
Ratchet Handle 45 teeth Cheie Clichet  
45 dinti

1/4" DR.

арт. №  
art. №

Размер  
Size

Баркод  
Barcode

339106P

1/4"



# SOCKET SET

- [BG] Комплект инструменти • [RO] Trusa chei tubulare
- [EL] Κασέτινα καρυδάκια • [PT] Jogo • [IT] Kit bussole
- [SR] Set nasadnih ključeva • [SL] Garnitura v kovčku • [BH] Set gedora
- [RU] Набор Сменных Головок • [MK] Сет алати



- 13 бр. 1/4" Вложки  
- 13 units 1/4" Dr. Sockets  
- 13 buc 1/4" Tubulare

4, 4.5, 5, 5.5, 6, 7, 8, 9, 10, 11, 12, 13, 14 mm



- Подвижна Свързка  
- Universal Joint  
- Adapter Tubulare Flexibil

1/4" DR.

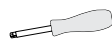

- Върток  
- Spinner Handle  
- Maner ptr Tubulare

1/4" DR.



- Adapter  
- Адаптер  
- Adapter

1/4" DR.



- Flexible Extension bar  
- Удължител за накрайници  
- Prelungitor Magnetic ptr Biti

1/4" DR.



- Върток Т-образен  
- Sliding T-bar  
- Levier Strangere Satin

1/4" DR. x 150 mm



- Удължител 2 броя  
- 2PC Extension Bar  
- Adapter Lung

1/4" DR. x 50, 100 mm



- Тресчотка 72 зъба  
- Ratchet Handle 72 teeth  
- Cheie Clichet 72 dinti

1/4" DR. x 150 mm



- 21 бр. Вложки с Накрайник  
- 21 PC 1/4" DR. Bit Socket  
- 21 buc 1/4" Tubulare cu bit

⊕ Phillips: PH1, PH2, PH3  
⊙ Hex: 3, 4, 5, 6, 7, 8 mm  
⊖ Slotted: 4, 5.5, 7 mm  
⊗ Pozi: PZ1, PZ2, PZ3  
⊛ Torx: T10, T15, T20, T25, T30, T40 mm



- Шестограми 3 броя  
- 3 PC Hex Key Wrenches  
- 3 buc Imbus Maner

1.5, 2, 2.5 mm

арт. №  
art. №

Размер  
Size

Баркод  
Barcode

339105P

1/4"



# SOCKET SET

- [BG] Комплект инструменти • [RO] Trusa chei tubulare • [EL] Κασέτινα καρυδάκια • [PT] Jogo • [IT] Kit bussole • [SR] Set nasadnih ključeva
- [SL] Garnitura v kovčku • [BH] Set gedora • [RU] Набор сменных головок • [MK] Сет алати



арт. № art. №	Размер Size	Баркод Barcode
339104P	1/2"	 318001231167478



- [BG]**
1. Релефно брандиран куфар
  2. Стоманени панти
  3. Матово хромирани, здрави, метални закопчалки
- [EN]**
1. Embossed branding suitcase
  2. Steel hinges
  3. Matte chrome, metal buckles
- [RO]**
1. gofrată valiza brandingul
  2. balamale din oțel
  3. crom mat, cleme de metal

	12 бр. 1/2" Вложки 12 units 1/2" Dr. Sockets 12 buc 1/2" Tubulare	10, 11, 12, 13, 14, 15, 16, 17, 18, 19, 22, 24 mm
	3 бр. 1/2" Удължени Вложки 3 units 1/2" Dr. Deep Sockets 3 buc 1/2" Lunga Tubulare	13, 17, 19 mm
	Подвижна Свързка Universal Joint Adapter Tubulare Flexibil	1/2" DR.
	- Адаптор Комбиниран - TM Head 1/2" DR. - Adapter 1/2" DR.	1/2" DR.
	2 бр. Вложка за Свещи 2 units Spark Plug Sockets 2 Buc Tubulara ptr Bujii	1/2" DR.x16 mm
	Удължител Extension Bar Adapter Lung	1/2" DR. x 250 mm
	Тресчотка 45 зъба Ratchet Handle 45 teeth Cheie Clichet 45 dinti	1/2" DR.



# SOCKET SET

- [BG] Комплект инструменти • [RO] Trusa chei tubulare • [EL] Κασέτινα καρυδάκια • [PT] Jogo • [IT] Kit bussole • [SR] Set nasadnih ključeva  
• [SL] Garnitura v kovčku • [BH] Set gedora • [RU] Набор сменных головок • [MK] Сет алати



2<sup>ND</sup>  
GENERATION



арт. №  
art. №

Размер  
Size

Баркод  
Barcode









339103P



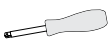



1/4" & 1/2"



318001231674611

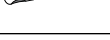

	13 бр. 1/4" Вложки 13 units 1/4" Dr. Sockets 13 buc 1/4" Tubulare	4, 4.5, 5, 5.5, 6, 7, 8, 9, 10, 11, 12, 13, 14 mm
	8 бр. 1/4" Удължени Вложки 8 units 1/4" Dr. Deep Sockets 8 buc 1/4" Lunga Tubulare	6, 7, 8, 9, 10, 11, 12, 13 mm
	- Подвижна Свързка - Universal Joint - Adapter Tubulare Flexibil	1/4" DR.
	- Върток - Spinner Handle - Maner ptr Tubulare	1/4" DR.
	- Върток Т-образен - Sliding T-bar - Levier Strangere Satin	1/4" DR.
	- Удължител 2 броя - 2PC Extension Bar - Adapter Lung	1/4" DR. x 50, 100mm
	- Тресчотка 72 зъба - Ratchet Handle 72 teeth - Cheie Clichet 72 dinti	1/4" DR.
	- 18 бр. Вложки с Накрайник - 18PC 1/4" DR. Bit Socket - 18 buc 1/4" Tubulare cu bit	⊕ Phillips: PH1, PH2 ● Hex: 3, 4, 5, 6 mm ⊖ Slotted: 4, 5.5, 7 mm ⊗ Pozi: PZ1, PZ2 ⊛ Torx: T8, 10, 15, 20, 25, 27, 30 mm
	15 бр. 1/2" Вложки 15 units 1/2" Dr. Sockets 15 buc 1/2" Tubulare	10, 13, 14, 15, 16, 17, 18, 19, 20, 21, 22, 24, 27, 30, 32 mm

	4 бр. 1/2" Удължени Вложки 4 units 1/2" Dr. Deep Sockets 4 buc 1/2" Lunga Tubulare	14, 15, 17, 19 mm
	2 бр. Вложка за Свещи 2 units Spark Plug Sockets 2 Buc Tubulara ptr Bujii	1/2" DR. x 16, 21 mm
	- Удължител 2 броя - 2PC Extension Bar - Adapter Lung	1/2" DR. x 125, 250 mm
	- Подвижна Свързка - Universal Joint - Adapter Tubulare Flexibil	1/2" DR.
	- Адаптор Комбиниран - TM Head 1/2" DR. - Adapter 1/2" DR.	1/2" DR.
	- Тресчотка 72 зъба - Ratchet Handle 72 teeth - Cheie Clichet 72 dintii	1/2" DR.
	- 15 бр. Накрайници 5/16" 30 mm - 15 PC Bits 5/16" 30 mm - 15 buc biti 5/16" 30 mm	⊕ Phillips: PH3, PH4 ● Hex: 8, 10, 12, 14 mm ⊖ Slotted: 8, 10, 12.5 mm ⊗ Pozi: PZ3, PZ4 ⊛ Torx: T40, T45, T50, T55 mm
	- Адаптер за накрайници - Bit Coupler - Imbus Furtun	1/2" DR. / 8 mm

# SOCKET SET

- [BG] Комплект инструменти • [RO] Trusa chei tubulare • [EL] Κάσεταινα καρυбаκια • [PT] Jogo • [IT] Kit bussole • [SR] Set nasadnih ključeva
- [SL] Garnitura v kovčku • [BH] Set gedora • [RU] Набор сменных головок • [MK] Сет алати



арт. №  
art. №      Размер  
Size      Баркод  
Barcode

339102P

1/4" & 1/2"



	13 бр. 1/4" Вложки 13 units 1/4" Dr. Sockets 13 buc 1/4" Tubulare	4, 4.5, 5, 5.5, 6, 7, 8, 9, 10, 11, 12, 13, 14 mm
	8 бр. 1/4" Удължени Вложки 8 units 1/4" Dr. Deep Sockets 8 buc 1/4" Lunga Tubulare	6, 7, 8, 9, 10, 11, 12, 13 mm
	5 бр. 1/4" DR. Вложки E-Torx 5 units 1/4" Dr. Star Sockets 5 buc 1/4" DR. Tubulare Cruce Dubla	E4, E5, E6, E7, E8
	- Подвижна Свързка - Universal Joint - Adapter Tubulare Flexibil	1/4" DR.
	- Върток - Spinner Handle - Maner ptr Tubulare	1/4" DR.
	- Върток Т-образен - Sliding T-bar - Levier Strangere Satin	1/4" DR.
	- Удължител 2 броя - 2PC Extension Bar - Adapter Lung	1/4" DR. x 50, 100mm
	- Тресчотка 45 зъба - Ratchet Handle 45 teeth - Cheie Clichet 45 dintii	1/4" DR. x 150mm
	- 18 бр. Вложки с Накрайник - 18PC 1/4" DR. Bit Socket - 18 buc 1/4" Tubulare cu bit	⊕ Phillips: PH1, PH2 ● Hex: 3, 4, 5, 6 mm ⊖ Slotted: 4, 5.5, 7 mm ⊖ Pozi: PZ1, PZ2 ⊕ Torx: T8, 10, 15, 20, 25, 27, 30 mm
	- Шестограм 4 броя - 4 PC Hex Key Wrenches - 4 buc Imbus Maner	1.5, 2, 2.5 mm

	17 бр. 1/2" Вложки 17 units 1/2" Dr. Sockets 17 buc 1/2" Tubulare	10, 11, 12, 13, 14, 15, 16, 17, 18, 19, 20, 21, 22, 24, 27, 30, 32 mm
	5 бр. 1/2" Удължени Вложки 5 units 1/2" Dr. Deep Sockets 5 buc 1/2" Lunga Tubulare	14, 15, 17, 19, 22 mm
	8 бр. 1/2" DR. Вложки E-Torx 8 units 1/2" Dr. Star Sockets 8 buc 1/2" DR. Tubulare Cruce Dubla	E10, E11, E12, E14, E16, E18, E20, E24
	2 бр. Вложка за Свещи 2units Spark Plug Sockets 2 buc Tubulara ptr Vujii	1/2" DR. x 16, 21 mm
	- Удължител 2 броя - 2PC Extension Bar - Adapter Lung	1/2" DR. x 125, 250 mm
	- Подвижна Свързка - Universal Joint - Adapter Tubulare Flexibil	1/2" DR.
	- Адаптор Комбиниран - TM Head 1/2" DR. - Adapter 1/2" DR.	1/2" DR.
	- Тресчотка 45 зъба - Ratchet Handle 45 teeth - Cheie Clichet 45 dintii	1/2" DR. x 250 mm
	16 бр. Накрайници 5/16"x30mm 16 PC 5/16" x 30mm Bits 16 Buc 5/16" x 30mm Biti	⊕ Phillips: PH3, PH4 ● Hex: 7, 8, 10, 12, 14 mm ⊖ Slotted: 8, 10, 12 mm ⊖ Pozi: PZ3, PZ4 ⊕ Torx: T40, 45, 50, 55, 60 mm
	- Адаптер за накрайници - Bit Coupler - Imbus Furtun	1/2" DR./ 8 mm

# SOCKET SET

- [BG] Комплект инструменти • [RO] Trusa chei tubulare • [EL] Κασέτινα καρμπάκια • [PT] Jogo • [IT] Kit bussole • [SR] Set nasadnih ključeva
- [SL] Garnitura v kovčku • [BH] Set gedora • [RU] Набор сменных головок • [MK] Сет алати



2<sup>ND</sup>  
GENERATION



арт. №  
art. №      Размер  
Size      Баркод  
Barcode

339107      1/4", 3/8" & 1/2"



318001231167508

X150

1/4"

3/8"

1/2"

Cr-V  
STEEL

DIN

45



- 13 бр. 1/4" Вложки  
- 13 units 1/4" Dr. Sockets  
- 13 buc 1/4" Tubulare      4, 4.5, 5, 5.5, 6, 7, 8, 9, 10, 11, 12, 13, 14 mm

- 6 бр. 1/4" Удължени Вложки  
- 6 units 1/4" Dr. Deep Sockets  
- 6 buc 1/4" Lunga Tubulare      4, 5, 6, 7, 8, 9 mm

- 5 бр. 1/4" DR. Вложки E-Torx  
- 5 units 1/4" Dr. Star Sockets  
- 5 buc 1/4" DR. Tubulare Cruce Dubla      E4, E5, E6, E7, E8

- Подвижна Свързка  
- Universal Joint  
- Adapter Tubulare Flexibil      1/4" DR.

- Върток  
- Spinner Handle  
- Maner ptr Tubulare      1/4" DR.

- Върток Т-образен  
- Sliding T-bar  
- Levier Strangere Satin      1/4" DR.

- Удължител 2 броя  
- 2PC Extension Bar  
- Adapter Lung      1/4" DR. x 50, 100 mm

- Тресчотка 45 зъба  
- Ratchet Handle 45 teeth  
- Cheie Clichet 45 dintii      1/4" DR.

- Адаптер за накрайници  
- Bit Coupler  
- Imbus Furtun      1/4" DR. / 8 mm

- 20 бр. Вложки с Накрайник  
- 20PC 3/8" DR. Bit Socket  
- 20 buc 3/8" Tubulare cu bit

⊕ Phillips: PH1, PH2, PH3  
⊙ Hex: 3, 4, 5, 6, 8, 10 mm  
⊖ Slotted: 4, 5.5, 6.5 mm  
⊗ Pozzi: PZ1, PZ2, PZ3  
⊛ Torx: T30, T40, T45, T50, T55

- Подвижна Свързка  
- Universal Joint  
- Adapter Tubulare Flexibil      3/8" DR.

- 6 бр. 3/8" DR. Вложки E-Torx  
- 6 units 3/8" Dr. Star Sockets  
- 6 buc 3/8" DR. Tubulare Cruce Dubla      E10, E11, E12, E14, E16, E18

- 11 бр. 3/8" Вложки  
- 11 units 3/8" Dr. Sockets  
- 11 buc 3/8" Tubulare      9, 10, 11, 12, 13, 14, 15, 16, 17, 18, 19 mm

- 6 бр. 3/8" Удължени Вложки  
- 6 units 3/8" Dr. Deep Sockets  
- 6 buc 3/8" Lunga Tubulare      10, 11, 12, 13, 14, 15 mm

- 2 бр. 3/8" DR. Вложка за Свещи  
- 2 units 3/8" DR. Spark Plug Sockets      3/8" DR. x 16, 21 mm  
- 2 Buc 3/8" DR. Tubulara ptr Bujii

- Тресчотка 45 зъба  
- Ratchet Handle 45 teeth      3/8" DR.  
- Cheie Clichet 45 dintii

- Шестограм 9 броя  
- 9 PC Hex Key Wrenches      1.5, 2, 2.5, 3, 4, 5, 6, 8, 10 mm  
- 9 buc Imbus Maner

- 17 бр. 1/2" Вложки  
- 17 units 1/2" Dr. Sockets  
- 17 buc 1/2" Tubulare      10, 11, 12, 13, 14, 15, 16, 17, 18, 19, 20, 21, 22, 24, 27, 30, 32 mm

- 6 бр. 1/2" Удължени Вложки  
- 6 units 1/2" Dr. Deep Sockets  
- 6 buc 1/2" Lunga Tubulare      10, 12, 13, 14, 17, 19 mm

- 3 бр. 1/2" DR. Ударни Вложки  
- 3 units 1/2" Dr. Impact Sockets      E20, E22, E24  
- 3 buc 1/2" DR. Tubulare Cruce Dubla

- 4 бр. 1/2" DR. Вложки E-Torx  
- 4 units 1/2" Dr. Star Sockets      17, 19, 21, 23mm  
- 4 buc 1/2" DR. Tubulare Impact

- Удължител 2 броя  
- 2PC Extension Bar  
- Adapter Lung      1/2" DR. x 125, 250mm

- Подвижна Свързка  
- Universal Joint  
- Adapter Tubulare Flexibil      1/2" DR.

- Адаптор Комбиниран  
- TM Head 1/2" DR.      1/2" DR.  
- Adapter 1/2" DR.

- Тресчотка 45 зъба  
- Ratchet Handle 45 teeth      1/2" DR.  
- Cheie Clichet 45 dintii

- 10 бр. 1/4" Накрайници  
- 10 PC 1/4 Shank Bits      ⊕ Torx: T10H, T15H, T20H,  
- 10 Buc 1/4 Biti      T25H, T27H, T30H, T40H,  
ST20, ST25, ST30

- Ключ звездогаечен 12бр  
- 12 PC Combination Wrench      8, 9, 10, 11, 12, 13, 14, 15, 16,  
- 12 buc Cheie combinata      17, 18, 19 mm

- Ключ тресчотка 3бр  
- 3 PC Ring end ratchet spanner      8x10, 12x13, 17x19 mm  
- 3 buc Cheie inelare double







# SOCKET SET





- [BG] Комплект инструменти • [RO] Trusa chei tubulare
- [EL] Κασέτινα καρυδάκια • [PT] Jogo • [IT] Kit bussole
- [SR] Set nasadnih ključeva • [SL] Garnitura v kovčku • [BH] Set gedora
- [RU] Набор Сменных Головок • [MK] Сет алати



арт. № art. №	Размер Size	Баркод Barcode
339203	1/4"	 3 480097 24016101

x46
1/4"
Cr-V STEEL
DIN
72

	- 13 бр. 1/4" Вложки - 13 units 1/4" Dr. Sockets - 13 buc 1/4" Tubulare	4, 4.5, 5, 5.5, 6, 7, 8, 9, 10, 11, 12, 13, 14 mm
	- Подвижна Свързка - Universal Joint - Adapter Tubulare Flexibil	1/4" DR.
	- Върток - Spinner Handle - Maner ptr Tubulare	1/4" DR.
	- Адаптер - Adapter - Adapter	1/4" DR.
	- Удължител за накрайници - Flexible Extension bar - Prelungitor Magnetic ptr Biti	1/4" DR.

	- Върток Т-образен - Sliding T-bar - Levier Strangere Satin	1/4" DR. x 150 mm
	- Удължители 2 бр. - 2 units Extension Bar - Adapter Lung	1/4" DR. x 50, 100 mm
	- Тресчотка 72 зъба - Ratchet Handle 72 teeth - Cheie Clichet 72 dinti	1/4" DR. x 155 mm
	- 21 бр. Вложки с накрайник - 21 units 1/4" DR. Bit Socket - 21 buc 1/4" Tubulare cu bit	⊕ Phillips: PH1, PH2, PH3 ● Hex: 3, 4, 5, 6, 7, 8 mm ⊖ Slotted: 4, 5.5, 7 mm ⊗ Pozi: PZ1, PZ2, PZ3 ⊕ Torx: T10, T15, T20, T25, T30, T40 mm
	- Шестограми 3 бр. - 3 units Hex Key Wrenches - 3 buc Imbus Maner	1.5, 2, 2.5 mm











# SOCKET SET









- [BG] Комплект инструменти • [RO] Trusa chei tubulare
- [EL] Κασέτινα καρυδάκια • [PT] Jogo • [IT] Kit bussole
- [SR] Set nasadnih ključeva • [SL] Garnitura v kovčku • [BH] Set gedora
- [RU] Набор Сменных Головок • [MK] Сет алати



арт. № art. №	Размер Size	Баркод Barcode
339204	1/4" & 1/2"	

x82
1/4"
1/2"
Cr-V STEEL
DIN
72



	- Върток T-образен - Sliding T-bar - Levier Strangere Satin	1/4" DR. x 115 mm
	- Удължител 2 бр. - 2 units Extension Bar - Adapter Lung	1/4" DR. x 50, 100 mm
	- Тресчотка 45 зъба - Ratchet Handle 45 teeth - Cheie Clichet 45 dinti	1/4" DR. x 155 mm
	- 17 бр. Вложки с накрайник - 17 units 1/4" DR. Bit Socket - 17 buc 1/4" Tubulare cu bit	<ul style="list-style-type: none"> <li>⊕ Phillips: PH1, PH2</li> <li>● Hex: 3, 4, 5, 6 mm</li> <li>⊖ Slotted: 4, 5, 7 mm</li> <li>⊗ Pozi: PZ1, PZ2</li> <li>⊙ Torx: T8, T10, T15, T20, T25, T30 mm</li> </ul>
	- Върток - Spinner Handle - Maner ptr Tubulare	1/4" DR. x 150 mm
	- Flexible Extension bar - Удължител за накрайници - Prelungitor Magnetic ptr Biti	1/4" DR. x 145 mm
	16 бр. Накрайници 5/16" x 30 mm 16 units 5/16" x 30 mm Bits 16 Buc 5/16" x 30 mm Biti	<ul style="list-style-type: none"> <li>⊕ Phillips: PH3, PH4</li> <li>● Hex: 7, 8, 10, 12 mm</li> <li>⊖ Slotted: 7, 8, 10, 12 mm</li> <li>⊗ Pozi: PZ3, PZ4</li> <li>⊙ Torx: T30, 40, 45, 50 mm</li> </ul>
	- Подвижна Свързка - Universal Joint - Adapter Tubulare Flexibil	1/4" DR.

	- 13 бр. 1/4" Вложки - 13 units 1/4" Dr. Sockets - 13 buc 1/4" Tubulare	4, 4.5, 5, 5.5, 6, 7, 8, 9, 10, 11, 12, 13, 14 mm
	- 12 бр. 1/2" Вложки - 12 units 1/2" Dr. Sockets - 12 buc 1/2" Tubulare	14, 15, 16, 17, 18, 19, 20, 22, 24, 27, 30, 32 mm
	- Подвижна Свързка - Universal Joint - Adapter Tubulare Flexibil	1/2" DR.
	- Тресчотка 45 зъба - Ratchet Handle 45 teeth - Cheie Clichet 45 dinti	1/2" DR. x 255 mm
	- Адаптор Комбиниран - TM Head 1/2" DR. - Adapter 1/2" DR.	1/2" DR.
	2 бр. Вложка за Свещи 2 units Spark Plug Sockets 2 Buc Tubulara ptr Buji	1/2" DR. x 16, 21 mm
	- Удължители 2 броя - 2 units Extension Bar - Adapter Lung	1/2" DR. x 125, 250 mm
	- Адаптер за накрайници - Bit Coupler - Imbus Furtun	1/2" DR. / 8 mm
	- Ключ звездогоачен 9 бр. - 9 units Combination Wrench - 9 buc Cheie combinata	8, 10, 11, 12, 13, 14, 17, 19, 22 mm









# SOCKET SET





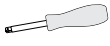

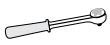



- [BG] Комплект инструменти • [RO] Trusa chei tubulare
- [EL] Κασέτινα καρυδάκια • [PT] Jogo • [IT] Kit bussole
- [SR] Set nasadnih ključeva • [SL] Garnitura v kovčku • [BH] Set gedora
- [RU] Набор Сменных Головок • [MK] Сет алати



арт. № art. №	Размер Size	Баркод Barcode
339206	1/4" & 1/2"	

x108
1/4"
1/2"
Cr-V STEEL
DIN
72

	13 бр. 1/4" Вложки 13 units 1/4" Dr. Sockets 13 buc 1/4" Tubulare	4, 4.5, 5, 5.5, 6, 7, 8, 9, 10, 11, 12, 13, 14 mm
	8 бр. 1/4" Удължени Вложки 8 units 1/4" Dr. Deep Sockets 8 buc 1/4" Lunga Tubulare	6, 7, 8, 9, 10, 11, 12, 13 mm
	5 бр. 1/4" DR. Вложки E-Torx 5 units 1/4" Dr. Star Sockets 5 buc 1/4" DR. Tubulare Cruce Dubla	E4, E5, E6, E7, E8
	- Подвижна Свързка - Universal Joint - Adapter Tubulare Flexibil	1/4" DR.
	- Върток - Spinner Handle - Maner ptr Tubulare	1/4" DR.
	- Върток T-образен - Sliding T-bar - Levier Strangere Satin	1/4" DR.
	- Удължител 2 броя - 2 units Extension Bar - Adapter Lung	1/4" DR. x 50, 100 mm
	- Тресчотка 45 зъба - Ratchet Handle 45 teeth - Cheie Clichet 45 dintii	1/4" DR. x 155 mm
	- 18 бр. Вложки с Накрайник - 18 units 1/4" DR. Bit Socket - 18 buc 1/4" Tubulare cu bit	⊕ Phillips: PH1, PH2 ● Hex: 3, 4, 5, 6 mm ⊖ Slotted: 4, 5.5, 6.5 mm ⊛ Pozi: PZ1, PZ2 ⊛ Torx: T8, 10, 15, 20, 25, 27, 30 mm
	- Шестограм 3 броя - 3 units Hex Key Wrenches - 3 buc Imbus Maner	1.5, 2, 2.5 mm

	17 бр. 1/2" Вложки 17 units 1/2" Dr. Sockets 17 buc 1/2" Tubulare	10, 11, 12, 13, 14, 15, 16, 17, 18, 19, 20, 21, 22, 24, 27, 30, 32 mm
	5 бр. 1/2" Удължени Вложки 5 units 1/2" Dr. Deep Sockets 5 buc 1/2" Lunga Tubulare	14, 15, 17, 19, 22 mm
	8 бр. 1/2" DR. Вложки E-Torx 8 units 1/2" Dr. Star Sockets 8 buc 1/2" DR. Tubulare Cruce Dubla	E10, E11, E12, E14, E16, E18, E20, E24
	2 бр. Вложка за Свещи 2 units Spark Plug Sockets 2 Buc Tubulara ptr Vujii	1/2" DR. x 16, 21 mm
	- Удължител 2 броя - 2 units Extension Bar - Adapter Lung	1/2" DR. x 125, 250 mm
	- Подвижна Свързка - Universal Joint - Adapter Tubulare Flexibil	1/2" DR.
	- Адаптор Комбиниран - TM Head 1/2" DR. - Adapter 1/2" DR.	1/2" DR.
	- Тресчотка 45 зъба - Ratchet Handle 45 teeth - Cheie Clichet 45 dintii	1/2" DR. x 250 mm
	17 бр. Накрайници 5/16"x30 mm 17 units 5/16" x 30 mm Bits 17 Buc 5/16" x 30 mm Biti	⊕ Phillips: PH3, PH4 ● Hex: 7, 8, 10, 12, 14 mm ⊖ Slotted: 8, 10, 12 mm ⊛ Pozi: PZ3, PZ4 ⊛ Torx: T40, 45, 50, 55, 60 mm
	- Адаптер за накрайници - Bit Coupler - Imbus Furtun	1/2" DR. / 8 mm









# SOCKET SET



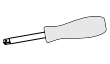







- [BG] Комплект инструменти • [RO] Trusa chei tubulare
- [EL] Κασέτινι καρυδάκια • [PT] Jogo • [IT] Kit bussole
- [SR] Set nasadnih ključeva • [SL] Garnitura v kovčku • [BH] Set gedora
- [RU] Набор Сменных Головок • [MK] Сет алати



арт. № art. №	Размер Size	Баркод Barcode
339207	1/4" & 3/8" & 1/2"	

X216
1/4"
3/8"
1/2"
Cr-V STEEL
DIN
72

	- 13 бр. 1/4" Вложки - 13 units 1/4" Dr. Sockets - 13 buc 1/4" Tubulare	4, 4.5, 5, 5.5, 6, 7, 8, 9, 10, 11, 12, 13, 14 mm
	- 18 бр. Удължени Вложки - 18 units Deep Sockets - 18 buc Lunga Tubulare	1/4" - 4, 5, 6, 7, 8, 9, 10 mm 3/8" - 10, 11, 12, 13, 14, 15 mm 1/2" - 16, 17, 18, 19, 22 mm
	- 14 бр. Вложки E-Torx - 14 units Star Sockets - 14 buc Tubulare Cruce Dubla	1/4" - E4, E5, E6, E7, E8 mm 3/8" - E10, E11, E12, E14, E16, E18 mm 1/2" - E20, E22, E24 mm
	- Върток - Spinner Handle - Maner ptr Tubulare	1/4" DR.
	- Върток Т-образен - Sliding T-bar - Levier Strangere Satin	1/4" DR.
	- Адаптери за накрайници - Bit Coupler - Imbus Furtun	1/4" - 1/4" 3/8" - 5/16" 1/2" - 5/16"
	- 30 бр. 1/4" DR. Вложки с накрайници - 30 units 1/4" DR. Bit Socket - 30 buc 1/4" DR. Tubulare cu bit	⊕ Phillips: PH0, PH1, PH2 ● Hex: 3, 4, 5, 6 mm ⊖ Slotted: 4, 5.5, 6.5, 7 mm ⊗ Torx: T8, T9, T10, T15, T20, T25, T27, T30, TS8, TS9, TS10, TS15, TS20, TS25, TS27, TS30 2 Units - 1/2" DR. BIT SOCKETS: T55, T60
	- 10 бр. 3/8" Вложки - 10 units 3/8" Dr. Sockets - 10 buc 3/8" Tubulare	10, 11, 12, 13, 14, 15, 16, 17, 18, 19 mm
	- 3 бр. Вложки за свещи - 3 units Spark Plug Sockets - 3 buc Tubulara ptr Vujii	3/8 DR. x 16 mm 1/2" DR. x 16, 21 mm
	- Шестограми 8 броя - 8 units Hex Key Wrenches - 8 buc Imbus Maner	1, 1.5, 2, 2.5, 3, 4, 5, 6 mm

	- 14 бр. 1/2" Вложки - 14 units 1/2" Dr. Sockets - 14 buc 1/2" Tubulare	13, 14, 15, 16, 17, 18, 19, 20, 21, 22, 24, 27, 30, 32 mm
	- Удължител 5 броя - 5 units Extension Bar - Adapter Lung	1/2" DR. x 125, 250 mm 3/8" DR. x 125 mm 1/4" DR. x 50, 100 mm
	- Кардани - Universal Joints - Adapter Tubulare Flexibil	1/4" DR. 3/8" DR. 1/2" DR.
	- Адаптор Комбиниран - TM Head 1/2" DR. - Adapter 1/2" DR.	1/2" DR.
	- Тресчотка - Ratchet Handles - Cheie Clichet	45 teeth 1/2" DR. 72 teeth 1/4" DR. 45 teeth 3/8" DR.
	- 44 бр. 1/4" Накрайници - 44 units 1/4" Shank Bits - 44 Buc 1/4" Biti	⊖ SL3, 4, 5, 5.5, 6, 6.5, 7, 8 mm ⊕ PH0; PH1; PH2; PH3 ⊗ PZ0; PZ1; PZ2; PZ3 ● HEX H2, 2.5, 3, 4, 5, 6, 7, 8 mm ⊗ Torx T8, 9, 10, 15, 20, 25, 27, 30, 40, 45 ⊙ Torx (hole) 8, 9, 10, 15, 20, 25, 27, 30, 40, 45
	- 30 бр. 5/16" Накрайници - 30 units 5/16" Shank Bits - 30 Buc 5/16" Biti	⊖ SL6, 6.5, 8 mm ⊕ PH3, PH4; ⊗ PZ3, PZ4 ● HEX H5.5, 6, 6.5, 7, 8, 10, 12; ⊗ Torx T27, 30, 35, 40, 45, 50; ⊙ Torx (hole) TT27, 30, 35, 40, 45, 50 ● M5, 6, 8, 10
	- 2 бр. 1/2" Накрайници - 2 units 1/2" Shank Bits - 2 Buc 1/2" Biti	
	- Ключове звездагачни 12 бр - 12 units Combination Spanners - 12 buc Cheie combinata	8, 9, 10, 11, 12, 13, 14, 15, 16, 17, 18, 19 mm
	- Отвертка за накрайници - Screwdriver - Surubelnita ptr biti	1/4"



# TOOL SET

- [BG] Комплект инструменти • [RO] Trusa scule • [EL] Κασέτινα εργαλείων • [PT] Conjunto de ferramentas • [IT] Kit bussole
- [SR] Set nasadnih ključeva • [SL] set orodja • [BH] Set gedora • [RU] Набор инструментов механика • [MK] Сет алати



**X48** **Cr-V** **S2**  
STEEL STEEL

арт. №  
art. №

Баркод  
Barcode

390909



Hexagon: 2 - 3 - 4 - 5 - 6 mm  
Slotted: 3 - 4 - 5.5 - 7 mm  
Phillips: ph0 - ph1 - ph2 - ph3  
Pozidriv: pz0 - pz1 - pz2 - pz3  
Torx: T10 - T15 - T20 - T25 - T27 - T30 - T40

1/4" 25 mm



Precision Screwdrivers:  
SL1.5\*45 mm  
PH00\*45 mm  
PH0\*45 mm

45 mm



Adjustable Wrench

200 mm



Snap off knife

18 mm

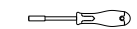

Screwdriver Bits Holder

1/4



Hex key

1.25 - 1.5 - 2 - 2.5  
- 3 - 3.5 - 4 - 4.5 - 5  
- 5.5 - 6 mm

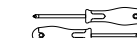

Screwdrivers: SL6\*100 mm, PH2\*100 mm

100 mm



Claw Hammer

300 g



Long nose Pliers

160 mm



Combination pliers

180 mm



Measuring tape 3M/16 mm

3 m

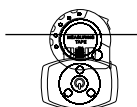

Head lamp 51\*42\*27 mm

51 mm



## STAR BIT SOCKET & E-SOCKET

- [BG] Вложки E-TORX и вложки с накрайник комплект • [RO] Set tubulare Torx E-Torx • [EL] Καρυδάκια & μύτες e-torx σετ
- [PT] Jogo • [IT] Kit bussole • [SR] Set nastavaka TORX na gedori • [SL] Nastavki TORX • [BH] Bit SET • [RU] Набор E - Торх Наконечников
- [MK] Сет E-Torx насадни клучеви



арт. №  
art. №

Размер  
Size

Баркод  
Barcode

330151

E10, E11, E12, E14, E16, E18, E20, E22, E24  
T30, T40, T45, T50, T55, T60, T70



x16

1/2"

Cr-V  
STEEL



## HEX BIT SOCKET SET

- [BG] Вложки с накрайник комплект • [RO] Set biti tubulara imbus • [EL] Μύτες άλλεν καρυδάκι σετ • [PT] Jogo Bits sextavados interior
- [IT] Kit bussole • [SR] Set nastavaka • [SL] Nastavki šestkotni • [BH] Bit SET • [RU] Набор Hex Наконечников • [MK] Ключ насаден hex сет



арт. №  
art. №

Размер  
Size

Баркод  
Barcode

330147

HW 4, HW 5, HW 6, HW 7, HW 8, HW 10,  
HW 12, HW 14, HW 17



x9

1/2"

Cr-V  
STEEL















# 2

## КЛЮЧОВЕ SPANNERS



## COMBINATION SPANNERS

- [BG] Ключ звездогаечен • [RO] Cheie combinata • [EL] Γερμανοπολύγωνο • [PT] Chave mista • [IT] Chiave combinata
- [SR] Ključ okasto viljuškasti • [SI] Ključ viličasto-obročni • [BH] Ključ viljuškasto-okasti • [RU] Гаечный ключ комбинированный
- [MK] Комбиниран вилушкаст окаст клуч

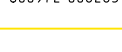
Art. № Art. №	Размер Size (mm)	L (mm)	B <sub>2</sub> (mm)	A <sub>2</sub> (mm)	B <sub>1</sub> (mm)	A <sub>1</sub> (mm)	C (mm)	box (N-m)	open (N-m)	Баркод Barcode
230171	10	140	23	5.6	15	6.2	3.3	86	37	
230172	11	150	26	5.8	17	6.6	3.3	97	56	
230173	12	160	27	6.4	19	6.8	3.9	109	59	
230174	13	170	29	6.6	20	7.9	3.9	140	76	
230175	14	180	32	6.7	21	8.3	4	242	103	
230176	15	190	33	7.2	22	8.3	4.4	243	127	
230177	16	200	35	7.2	24	8.9	4.4	300	153	
230178	17	210	37	7.8	25	9.4	4.7	322	169	
230179	18	220	39	8.1	27	9.7	4.7	366	187	
230180	19	230	41	8.3	28	10.4	5.2	393	228	
230181	21	250	45	8.5	31	10.6	5.5	451	302	
230182	22	260	47	8.8	33	11.3	5.8	495	338	
230183	24	280	50	9.15	35	12.3	6.3	614	415	



**30**  
YEARS  
WARRANTY

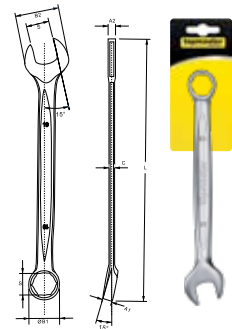

**6x GRIP ON**  
works on up to  
**85% damaged**  
bolts & nuts

**6x**  
GRIP ON

**Cr-V**  
STEEL

**HEAVY**  
DUTY

## COMBINATION SPANNER SET

- [BG] Ключове звездогаечни комплект • [RO] Set chei combinate • [EL] Γερμανοπολύγωνα σετ • [PT] Jogo mistas • [IT] Chiavi combinate
- [SR] Set okasto-viljuškastih ključeva hromirani • [SI] Viličasto-obročni ključji • [BH] Ključ. Okasto-viljušk. Set • [RU] Набор гаечных ключей
- [MK] Гарнитура комбинирани клучеви

**6x GRIP ON**  
works on up to  
**85% damaged**  
bolts & nuts

Art. № Art. №	Брой pieces	Размер Size (mm)	Баркод Barcode
230184	12	8, 9, 10, 11, 12, 13, 14, 15, 16, 17, 18, 19	



**30**  
YEARS  
WARRANTY



**x12**

**6x**  
GRIP ON

**Cr-V**  
STEEL

**HEAVY**  
DUTY

# COMBINATION SPANNER

- [BG] Ключ звездогаечен • [RO] Cheie combinata • [EL] Γερμανοπολύγωνο • [PT] Chave mista • [IT] Chiave combinata
- [SR] Ključ okasto viljuškasti • [SI] Ključ viličasto-obročni • [BH] Ključ viljuškasto-okasti • [RU] Гаечный ключ комбинированный
- [MK] Комбиниран вилушкаст окаст клуч



Art. № Art. №	S (mm)	L (mm)	B <sub>2</sub> (mm)	A <sub>2</sub> (mm)	B <sub>1</sub> (mm)	A <sub>1</sub> (mm)	C (mm)	Torque (Nm)		Баркод Barcode
								OPEN END	RING END	
235151	6	100	16	3.4	10.6	4.8	2.6	5.92	17.60	
235152	7	110	16.8	3.6	11.6	5.4	2.8	9.12	25.20	
235153	8	115	18.8	3.8	12.8	5.6	3.0	13.30	34.50	
235154	9	125	20.9	4.1	14.4	6	3.3	18.40	45.40	
235155	10	135	22.6	4.5	16	6.3	3.4	24.80	58.10	
235156	11	145	24	4.9	17.2	6.8	3.5	32.30	72.70	
235157	12	155	26.4	5	18.5	7.2	3.7	41.20	89.10	
235158	13	171	28.1	5.6	20.2	8.3	4.1	51.60	107	
235159	14	181	30.1	5.7	21.2	8.5	4.3	63.50	128	
235160	15	185	32.1	6.1	23	9.2	4.4	77.00	150	
235161	16	195	34.2	6.5	24.4	9.3	4.4	92.30	175	
235162	17	210	36	6.8	25	9.6	4.4	107	201	
235163	18	220	37.5	7.2	27.5	10.1	4.8	128	230	
235164	19	230	40.2	7.3	28.6	10.2	4.9	149	261	
235165	20	240	41.4	7.4	30.4	10.8	5.0	172	294	
235166	21	245	43.2	7.6	31.8	11.1	5.1	193	330	
235167	22	257	45.8	7.9	33	11.7	5.4	225	368	
235168	23	260	47.5	8.1	34.8	12.2	5.5	255	408	
235169	24	270	50	8.4	36	12.8	5.6	287	451	
235170	27	300	55	9.1	39.5	13.9	6.2	399	594	
235171	30	330	60.1	9.9	43.5	15.2	6.8	536	760	
235172	32	350	64	10.2	46.8	15.9	7.5	643	884	

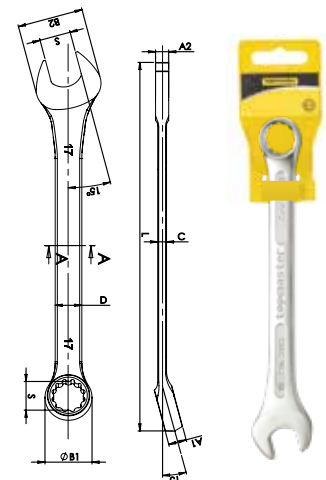





## COMBINATION SPANNER SET

- [BG] Ключове звездогаечни комплект • [RO] Set chei combinate • [EL] Γερμανοπολύγωνα σετ • [PT] Jogo mistas • [IT] Chiavi combinate
- [SR] Set okasto-viljuškastih ključeva hromirani • [SI] Viličasto-obročni ključiči • [BH] Ključ. Okasto-viljušk. Set • [RU] Набор гаечных ключей
- [MK] Гарнитура комбинирани клучеви



Арт. № Art. №	Брой pieces	Размер Size (mm)	Баркод Barcode
235124	8	8, 9, 10, 11, 13, 14, 17, 19	 3 800123 101946
235125	12	8, 7, 8, 9, 10, 11, 12, 13, 14, 17, 19, 22	 3 800123 101953



## COMBINATION SPANNER SET

- [BG] Ключове звездогаечни комплект • [RO] Set chei combinate • [EL] Γερμανοπολύγωνα σετ • [PT] Jogo mistas • [IT] Chiavi combinate
- [SR] Set okasto-viljuškastih ključeva hromirani • [SI] Viličasto-obročni ključiči • [BH] Ključ. Okasto-viljušk. Set • [RU] Набор гаечных ключей
- [MK] Гарнитура комбинирани клучеви



Арт. № Art. №	Брой pieces	Размер Size (mm)	Баркод Barcode
235128	25	6, 7, 8, 9, 10, 11, 12, 13, 14, 15, 16, 17, 18, 19, 20, 21, 22, 23, 24, 25, 26, 27, 28, 30, 32	 3 800123 101984



# COMBINATION SPANNER

- [BG] Ключ звездогаечен • [RO] Cheie combinata • [EL] Γερμανοπολυγωνο • [PT] Chave mista • [IT] Chiave combinata
- [SR] Ključ okasto viljuškasti • [SI] Ključ viličasto-obročni • [BH] Ključ viljuškasto-okasti • [RU] Гаечный ключ комбинированный
- [MK] Комбиниран вилушкаст окаст клуч



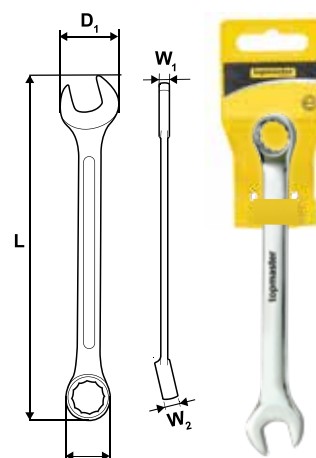

арт. № art. №	Размер Size (mm)	L (mm)	D <sub>1</sub> (mm)	W <sub>1</sub> (mm)	D <sub>2</sub> (mm)	W <sub>2</sub> (mm)	Баркод Barcode
230501	6	100	14.20	3.80	11.00	5.50	
230502	7	110	16.00	4.60	12.60	5.20	
230503	8	120	18.20	4.30	12.80	6.50	
230504	9	130	20.10	5.30	14.90	7.50	
230505	10	140	20.20	6.60	15.50	8.10	
230506	11	150	24.30	5.50	17.60	8.30	
230507	12	160	26.00	4.90	19.40	7.70	
230508	13	170	28.80	5.90	20.50	7.85	
230509	14	180	31.00	6.30	21.80	9.00	
230510	15	190	30.90	5.90	22.70	9.20	
230511	16	200	34.90	6.20	24.00	9.30	
230512	17	210	35.10	6.20	25.60	9.30	
230513	18	220	37.70	6.60	27.20	9.70	
230514	19	230	38.20	7.00	27.60	10.80	
230515	20	240	42.50	7.10	30.00	11.40	
230516	21	250	43.20	7.20	31.50	11.90	
230517	22	260	45.10	7.80	33.80	11.80	
230518	23	265	47.10	6.80	33.00	11.80	
230519	24	280	51.70	7.50	35.10	12.20	
230520	27	310	57.50	8.30	39.30	13.50	
230521	30	340	61.80	9.30	43.50	14.80	
230522	32	360	67.00	10.20	46.70	16.80	
230527	36	383	73.00	12.00	54.00	20.00	
230528	41	435	82.00	14.00	60.00	21.00	
230529	46	538	97.00	16.00	73.00	24.00	



## COMBINATION SPANNER SET

- [BG] Ключове звездогаечни комплект • [RO] Set chei combinate • [EL] Γερμανοπολυγωνα σετ • [PT] Jogo mistas • [IT] Chiavi combinate
- [SR] Set okasto-viljuškastih ključeva hromirani • [SI] Viličasto-obročni ključiči • [BH] Ključ. Okasto-viljušk. Set • [RU] Набор гаечных ключей
- [MK] Гарнитура комбинирани клучеви



арт. № art. №	брой pieces	Размер Size (mm)	Баркод Barcode
235111	6	8, 10, 12, 13, 14, 17	 3 800 123 11 116 9 51
235112	8	8, 9, 10, 11, 13, 14, 17, 19	 3 800 123 11 117 0 91
235113	12	6, 7, 8, 9, 10, 11, 12, 13, 14, 17, 19, 22	 3 800 123 11 117 1 61
230603	12	10, 11, 12, 13, 14, 17, 19, 22, 24, 27, 30, 32	 3 800 123 17 35 47



## COMBINATION SPANNER SET

- [BG] Ключове звездогаечни комплект • [RO] Set chei combinate • [EL] Γερμανοπολυγωνα σετ • [PT] Jogo mistas • [IT] Chiavi combinate
- [SR] Set okasto-viljuškastih ključeva hromirani • [SI] Viličasto-obročni ključiči • [BH] Ključ. Okasto-viljušk. Set • [RU] Набор гаечных ключей
- [MK] Гарнитура комбинирани клучеви



арт. № art. №	брой pieces	Размер Size (mm)	Баркод Barcode
230604	12	10, 11, 12, 13, 14, 17, 19, 22, 24, 27, 30, 32	 3 800 123 17 35 54



# COMBINATION SPANNER SET

- [BG] Ключове звездогаечни комплект • [RO] Set chei combinate • [EL] Γερμανοπολυγωνο σετ • [PT] Jogo mistas • [IT] Chiavi combinate
- [SR] Set okasto-viljuškastih ključeva hromirani • [SI] Viličasto-obročni ključiči • [BH] Ključ. Okasto-viljušk. Set • [RU] Набор гаечных ключей
- [MK] Гарнитура комбинирани клучеви



Sizes: 6, 7, 8, 9, 10, 11, 12, 13, 14, 15, 16, 17, 18, 19, 20, 21, 22, 23, 24, 25, 26, 27, 28, 30, 32 mm





арт. № art. №	брой pieces	Размер Size (mm)	Баркод Barcode
235114	25	6-32	 3 800123 111723



# AVIATION WRENCH

- [BG] Ключ удължен • [RO] Cheie inelara lunga • [EL] Πολύγωνο Μακρύ • [PT] Chave mista
- [IT] Chiave combinata • [SR] Ključ okasti • [SI] Ključ viličasto-obročni • [BH] Ključ viljuškasto-okasti
- [RU] Гаечный ключ комбинированный • [MK] Комбиниран вилушкаст окаст клуч



Арт. № Art. №	Размер Size (mm)	L (mm)	W (mm)	Φ (mm)	H (mm)	D (mm)	Баркод Barcode
231943	10 x 12	328	18	21	9.8	11.2	 3 800972 005587
231940	11 x 13	328	18	21	9.8	11.2	 3 800972 000247
231941	14 x 15	370	21	22.5	10.7	11.8	 3 800972 000254
231942	16 x 17	409	26.5	28.5	12.8	13.8	 3 800972 000261
231944	18 x 19	409	26.5	28.5	12.8	13.8	 3 800972 005594





# COMBINATION RATCHET WRENCH

- [BG] Ключ звездагаечен с тресчотка • [RO] Cheie combinata cu clichet • [EL] Γερμανοπολύγωνο καστάνιας • [PT] Chave boca
- [IT] Chiave combinata a cricchetto • [SR] Ključ viljuškasto okasti čegrtaljka • [SI] Ključ viličasto-obročni z ragljo
- [BH] Ključ viljuškasto-okasti sa račnom • [RU] Ключ зубчатый • [MK] Комбиниран вилушкаст окаст клуч со крцкало



арт. № art. №	Размер Size (mm)	L (mm)	D <sub>1</sub> (mm)	W <sub>1</sub> (mm)	D <sub>2</sub> (mm)	W <sub>2</sub> (mm)	Баркод Barcode
231901	8	140	18.0	4.8	18.3	7.2	
231902	9	150	20.0	4.8	20.0	7.5	
231903	10	160	22.0	5.1	21.5	7.8	
231904	11	165	24.5	5.5	23.5	8.4	
231905	12	170	26.0	5.9	25.0	8.8	
231906	13	180	28.0	6.4	26.4	9.1	
231907	14	190	30.8	6.7	28.0	9.4	
231908	15	200	33.0	7.3	30.0	9.8	
231909	16	210	34.5	7.8	31.5	10.2	
231910	17	225	37.0	8.0	33.0	10.5	
231911	18	235	39.5	8.2	35.0	10.8	
231912	19	245	40.8	8.4	36.5	11.2	
231913	20	245	40.8	8.4	36.5	11.2	
231914	21	290	44.8	9.0	42.5	13.5	
231915	22	290	44.8	9.0	42.5	13.5	
231916	24	332	52.8	9.7	48.5	14.5	

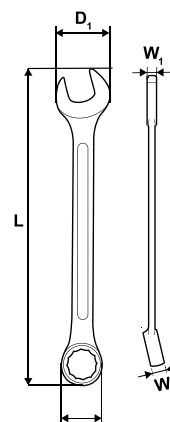

# COMBINATION RATCHET WRENCH

**NEW**

- [BG] Ключ звездагаечен с тресчотка • [RO] Cheie combinata cu clichet • [EL] Γερμανοπολύγωνο καστάνιας • [PT] Chave boca
- [IT] Chiave combinata a cricchetto • [SR] Ključ viljuškasto okasti čegrtaljka • [SI] Ključ viličasto-obročni z ragljo
- [BH] Ključ viljuškasto-okasti sa račnom • [RU] Ключ зубчатый • [MK] Комбиниран вилушкаст окаст клуч со крцкало



арт. № art. №	Размер Size (mm)	L (mm)	D <sub>1</sub> (mm)	W <sub>1</sub> (mm)	D <sub>2</sub> (mm)	W <sub>2</sub> (mm)	Баркод Barcode
231971	8	142	18	4.6	18	8	
231972	9	150	18.5	5	21	8	
231973	10	160	22	5.2	23.5	9	
231974	11	166	24	5.6	24	9	
231975	12	174	27	5.7	26	9.5	
231976	13	182	28	5.8	26.5	9.5	
231977	14	190	31	6	30	10	
231978	15	198	32.5	6.2	30.5	10	
231979	16	206	34	6.3	33	10.5	
231980	17	214	35	6.5	33.5	10.5	
231981	18	222	36	6.8	35.5	11	
231982	19	230	37	7.2	36.5	11	
231984	21	250	43	9	40	12.5	
231985	22	255	45	9.5	41	12.5	
231987	24	290	50	9.5	46	13.5	
231988	25	290	50	9.5	46	13.5	
231990	27	310	53.5	10	50	14	
231992	30	340	55	10	60	15	
231993	32	380	60	10	63	15	

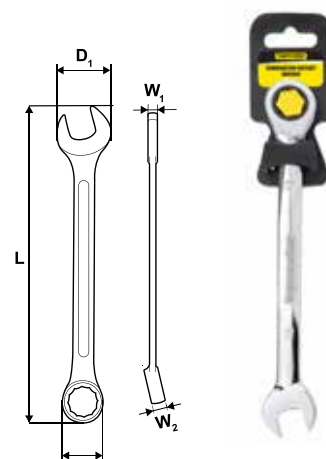

**Cr-V STEEL** **72** **MIRROR POLISH**

## RATCHET WRENCH SET

- [BG] Ключове с тресчотка • [RO] Set chei inelare cu clichet • [EL] Πολύγωνα κασάνια σeт • [PT] Chave luneta com roquete
- [IT] Chiave anulare a cricco • [SR] Set ključeva okasti ravni sa čegrtaljkom • [SI] Ključ viličasto-obročni z ragljo
- [BH] Ključ viljuškasto-okasti sa račnom • [RU] Ключ зубчатый • [MK] Звездест клуч со крцкало



арт. № art. №	брой pieces	Размер Size (mm)	Баркод Barcode
231970	6	8, 10, 12, 13, 15, 17	



## FLEXIBLE RATCHET COMBINATION WRENCH

- [BG] Ключ звездагаечен с тресчотка • [RO] Cheie combinata flexibila cu clichet • [EL] Γερμανοπολύγωνο κασάνια σπαστό • [PT] Chave boca
- [IT] Chiave combinata a cricchetto • [SR] Ključ viljuškasto okasti čegrtaljka zglobni • [SI] Ključ viličasto-obročni z ragljo
- [BH] Ključ viljuškasto-okasti sa račnom • [RU] Ключ зубчатый • [MK] Ключ вилушкаст со крцкало со зглоб



арт. № art. №	Размер Size (mm)	L (mm)	D <sub>1</sub> (mm)	W <sub>1</sub> (mm)	D <sub>2</sub> (mm)	W <sub>2</sub> (mm)	Баркод Barcode
231928	8	140	18.0	4.8	18.3	7.2	
231929	9	150	20.0	4.8	20.0	7.5	
231924	10	160	22.0	5.1	21.5	7.8	
231931	12	170	26.0	5.9	25.0	8.8	
231925	13	180	28.0	6.4	26.4	9.1	
231932	14	190	30.8	6.7	28.0	9.4	
231933	15	200	33.0	7.3	30.0	9.8	
231934	16	210	34.5	7.8	31.5	10.2	
231926	17	225	37.0	8.0	33.0	10.5	
231935	18	235	39.5	8.2	35.0	10.8	
231927	19	245	40.8	8.4	36.5	11.2	
231936	22	290	44.8	9.0	42.5	13.5	
231937	24	332	52.8	9.7	48.5	14.5	

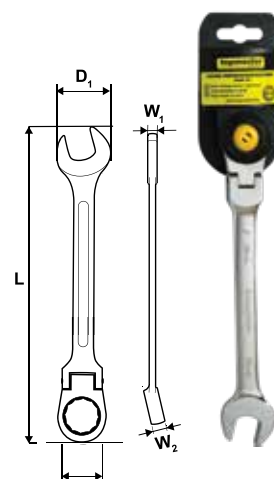

# STUBBY COMBINATION RATCHET WRENCH

- [BG] Ключ звездогаечен с тресчотка • [RO] Cheie inelara scurta cu clichet • [EL] Γερμανοπολύγωνο καστανίας • [PT] Chave boca
- [IT] Chiave combinata a cricchetto • [SR] Ključ viljuškasto okasti čegrtaljka • [SI] Ključ viličasto-obročni z ragljo
- [BH] Ključ viljuškasto-okasti sa račnom • [RU] Ключ тресчатый зубчатый • [MK] Комбиниран вилушкаст окаст клуч со крцкало



арт. № art. №	Размер size (mm)	L (mm)	D <sub>1</sub> (mm)	W <sub>1</sub> (mm)	D <sub>2</sub> (mm)	W <sub>2</sub> (mm)	Баркод Barcode
231917	10	96	22.0	5.1	21.5	7.8	
231918	13	115	28.0	6.4	26.4	9.1	
231919	17	132	37.0	8.0	33.0	10.5	
231920	19	138	40.8	8.4	36.5	11.2	

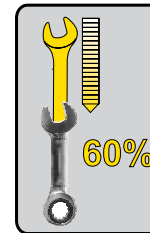

# AVIATION RATCHET WRENCH

- [BG] Ключ с тресчотка удължен • [RO] Cheie inelara lunga cu clichet • [EL] Γερμανοπολύγωνο καστανίας μακρύ
- [PT] Chave boca • [IT] Chiave combinata a cricchetto • [SR] Ključ okasti čegrtaljka • [SI] Ključ viličasto-obročni z ragljo
- [BH] Ključ viljuškasto-okasti sa račnom • [RU] Ключ зубчатый • [MK] Комбиниран вилушкаст окаст клуч со крцкало



Арт. № Art. №	Размер Size (mm)	L (mm)	W (mm)	Φ (mm)	H (mm)	D (mm)	Баркод Barcode
231950	10	295	16	21.5	8.3	7.8	
231951	12	331	19.5	25	10	8.8	
231952	13	351	20.8	26.4	10.5	9.1	
231953	14	371	22	28	11	9.4	
231954	15	378	23.5	30	11.5	9.8	
231955	16	393	25	31.5	12	10.2	
231956	17	412	26.3	33	12.8	10.5	





# DOUBLE OPEN END SPANNER

- [BG] Ключ гаечен • [RO] Cheie fixa • [EL] Γερμανικό • [PT] Chave boca • [IT] Chiave fissa • [SR] Ključ viljuškasti
- [SI] Viličasti ključ • [BH] Ključ viljuškasti • [RU] Ключ рожковый двусторонний • [MK] Двостран вилушкаст клуч



арт. № art. №	S <sub>1</sub> (mm)	S <sub>2</sub> (mm)	L (mm)	B <sub>1</sub> (mm)	A <sub>1</sub> =A <sub>2</sub> (mm)	B <sub>2</sub> (mm)	C (mm)	Torque (N/m)		Баркод Barcode
								SMALL END	BIG END	
235129	6	7	126	15.8	3.5	17.5	2.6	5.92	9.12	
235130	8	9	142	19.4	3.6	21	2.6	13.30	18.40	
235131	10	11	157	23	4.5	25.1	3.0	24.80	32.30	
235132	12	13	170	27.5	5.1	30	3.3	41.20	51.60	
235133	14	15	188	30.4	5.4	32.3	3.6	63.50	77.00	
235134	16	17	202	33.4	6.1	35.9	4.0	92.30	107	
235135	18	19	220	38.7	6.7	40.4	4.0	128	149	
235136	20	22	232	43.6	7.3	48.2	4.4	172	225	
235137	24	27	265	52.3	8	56.7	5.3	287	399	
235138	25	28	275	54.5	8.8	59.5	5.8	322	442	
235139	30	32	298	61.5	9.2	65.4	6.2	536	643	

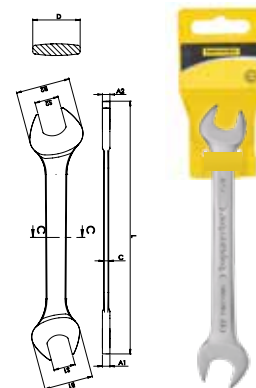

# DOUBLE OPEN END SPANNER SET

- [BG] Ключове гаечни комплект • [RO] Set chei fixe • [EL] Γερμανικά σετ • [PT] Jogo de bocas • [IT] Chiavi fisse • [SR] Set viljuškastih ključeva sa matiranjem glavom • [SI] Viličasti ključji • [BH] Ključ okasti • [RU] Набор гаечных ключей • [MK] Гарнитура вилушкasti клучеви



арт. № art. №	број pieces	Размер Size (mm)	Баркод Barcode
235121	8	6-7, 6-8, 10-11, 12-13, 14-15, 16-17, 18-19, 20-22	
235122	12	6-7, 8-9, 10-11, 12-13, 14-5, 16-17, 18-19, 20-22, 21-23, 24-27, 25-28, 30-32	



# DOUBLE OPEN END SPANNER

- [BG] Ключ гаечен • [RO] Cheie fixa • [EL] Γερμανικό • [PT] Chave boca • [IT] Chiave fissa • [SR] Ključ viljuškasti
- [SI] Viličasti ključ • [BH] Ključ viljuškasti • [RU] Ключ рожковый двусторонний • [MK] Двостран вилушкаст клуч



арт. № art. №	Размер Size (mm)	L (mm)	D <sub>1</sub> (mm)	W <sub>1</sub> (mm)	D <sub>2</sub> (mm)	W <sub>2</sub> (mm)	Баркод Barcode
230101	6x7	120	15.80	3.90	17.50	4.00	
230102	8x9	140	19.20	3.20	21.40	3.70	
230103	10x11	155	24.50	4.90	27.40	5.00	
230104	12x13	170	27.80	5.20	30.60	5.30	
230105	14x15	177	31.80	5.70	34.10	5.80	
230106	16x17	200	34.40	6.10	37.50	6.20	
230107	18x19	220	39.00	6.60	41.50	6.70	
230108	20x22	235	42.60	7.50	47.30	7.70	
230109	21x23	250	44.00	6.90	47.90	7.00	
230110	24x27	265	49.20	8.25	54.40	8.50	
230111	25x28	280	51.40	7.80	57.30	8.00	
230112	30x32	300	59.80	9.50	63.60	9.90	

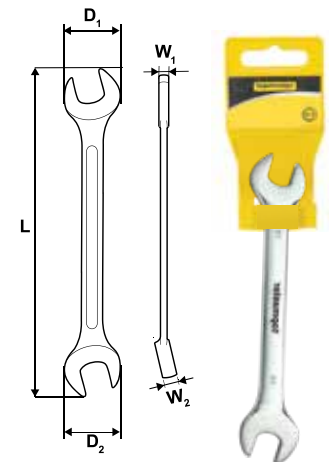

# DOUBLE OPEN END SPANNER SET

- [BG] Ключове гаечни комплект • [RO] Set chei fixe • [EL] Γερμανικά σετ • [PT] Jogo de bocas • [IT] Chiavi fisse • [SR] Set viljuškastih ključeva sa matiranom glavom • [SI] Viličasti ključ • [BH] Ključ okasti • [RU] Набор гаечных ключей • [MK] Гарнитура вилушкасти клучеви



арт. № art. №	брой pieces	Размер Size (mm)	Баркод Barcode
235115	6	6-7, 8-9, 10-11, 12-13, 14-15, 16-17	
235116	8	6-7, 6-8, 10-11, 12-13, 14-15, 16-17, 18-19, 20-22	
235117	12	6-7, 8-9, 10-11, 12-13, 14-5, 16-17, 18-19, 20-22, 21-23, 24-27, 25-28, 30-32	



## DOUBLE RATCHET WRENCH

- [BG] Ключ с тресчотка • [RO] Cheie dubla inelara cu clichet • [EL] Πολύγωνο καστανίας • [PT] Chave luneta com roquete
- [IT] Chiave anulare doppia a cricco • [SR] Ključ okasti ravni sa čegrtaljkom • [SI] Ključ viličasto-obročni z ragljo
- [BH] Ključ viljuškasto-okasti sa račnom • [RU] Ключ зубчатый • [MK] Двостран звездет клуч со крцкало

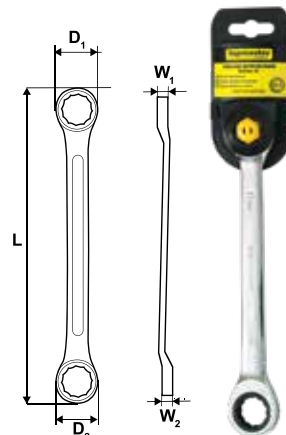

арт. № art. №	Размер Size (mm)	L (mm)	D <sub>1</sub> (mm)	W <sub>1</sub> (mm)	D <sub>2</sub> (mm)	W <sub>2</sub> (mm)	Баркод Barcode
231921	8x10	130	18.3	7.2	21.5	7.8	
231922	12x13	170	25.0	8.8	26.4	9.2	
231923	17x19	235	33.0	10.5	36.5	11.2	



## DOUBLE RATCHET WRENCH SET

- [BG] Ключове с тресчотка • [RO] Set chei duble inelare cu clichet • [EL] Πολύγωνο καστανίας σετ • [PT] Chave luneta com roquete
- [IT] Chiave anulare doppia a cricco • [SR] Set ključeva okasti ravni sa čegrtaljkom • [SI] Ključ viličasto-obročni z ragljo
- [BH] Ključ viljuškasto-okasti sa račnom • [RU] Ключ зубчатый • [MK] Двостран звездет клуч со крцкало



арт. № art. №	брой pieces	Размер Size (mm)	Баркод Barcode
231900	6	8x9, 10x11, 12x13, 14x15, 16x18, 17x19	



# DOUBLE RATCHET WRENCH

- [BG] Ключ гаечен с тресчотка • [RO] Cheie dubla inelara cu clichet • [EL] Πολύγωνο καστανίας • [PT] Chave luneta com roquete
- [IT] Chiave anulare doppia a cricco • [SR] Ključ okasti ravni sa čegrtaljkom • [SI] Ključ viličasto-obročni z razglo
- [BH] Ključ viljuškasto-okasti sa račnom • [RU] Ключ зубчатый • [MK] Двостран ѕвездест клуч со крчкало

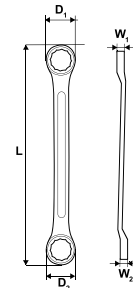

арт. № art. №	Размер Size (mm)	L (mm)	D <sub>1</sub> (mm)	W <sub>1</sub> (mm)	D <sub>2</sub> (mm)	W <sub>2</sub> (mm)	Баркод Barcode
231938	10x13x17x19	200	29	17	35	22	

# BI-HEXAGONAL RING SPANNERS

- [BG] Ключ лула • [RO] Cheie inelara cotita • [EL] Πολύγωνο • [PT] Chave luneta • [IT] Chiave anulare a gomito • [SR] Ključ okasto-lulasti
- [SI] Obročni ključ • [BH] Ključ okasti • [RU] Ключ накидной изогнутый • [MK] Ключ за скелиња



арт. № art. №	S <sub>1</sub> (mm)	S <sub>2</sub> (mm)	L (mm)	B <sub>1</sub> (mm)	A <sub>1</sub> (mm)	B <sub>2</sub> (mm)	A <sub>2</sub> (mm)	C (mm)	Torque (N/m)		Баркод Barcode
									S <sub>1</sub>	S <sub>2</sub>	
235140	6	7	175	10.5	5	11.4	5.8	4.4	17.6	25.2	
235141	8	9	185	13.2	6	14.5	7	4.5	34.5	45.4	
235142	10	11	198	16.8	7.4	17.9	8.4	5.2	58.1	72.7	
235143	12	13	215	19.5	8.4	20.6	9.1	5.4	89.1	107	
235144	14	15	228	22.2	9.5	23	10.4	5.6	128	150	
235145	16	17	246	24.8	10	26	10.8	6.2	175	201	
235146	18	19	268	28.2	10.8	29.2	12.1	6.4	230	261	
235147	20	22	292	30.9	11.7	31.8	12.5	6.9	294	368	
235148	21	23	315	32	12.2	33.8	13.4	7.1	330	408	
235149	24	27	328	36.7	12.2	40.9	13.2	7.6	451	594	
235150	30	32	370	43.2	15.2	46.5	16	8.8	760	884	

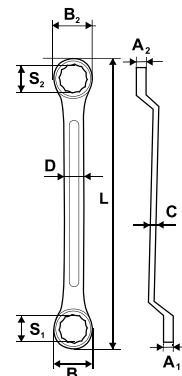



## BI-HEXAGONAL RING SPANNERS

- [BG] Ключове лули комплект • [RO] Set chei inelare cotite • [EL] Πολύγωνα σετ • [PT] Jogo luneta estampadas • [IT] Chiavi anulari a gomito
- [SR] Set hromiranih okastih ključeva • [SI] Garnitura obročnih ključev • [BH] Ključ okasti • [RU] Набор Ключей накладных
- [MK] Ключ за скелиња



арт. № art. №	број pieces	Размер Size (mm)	Баркод Barcode
235126	8	6-7, 8-9, 10-11, 12-13, 14-15, 16-17, 18-19, 20-22	



## BI-HEXAGONAL RING SPANNERS

- [BG] Ключ лула • [RO] Cheie inelara cotita • [EL] Πολύγωνο • [PT] Chave luneta • [IT] Chiave anulare a gomito • [SR] Ključ okasto-lulasti
- [SI] Obročni ključ • [BH] Ključ okasti • [RU] Ключ накладной изогнутый • [MK] Ключ за скелиња



арт. № art. №	Размер Size (mm)	L (mm)	D <sub>1</sub> (mm)	W <sub>1</sub> (mm)	D <sub>2</sub> (mm)	W <sub>2</sub> (mm)	Баркод Barcode
230901	6x7	180	11.80	6.10	13.00	6.80	
230902	8x9	195	14.80	6.60	15.80	7.00	
230903	8x10	195	14.80	6.60	15.80	7.00	
230904	10x11	200	16.30	8.10	18.00	8.80	
230905	10x12	205	16.30	8.10	21.50	9.80	
230906	12x13	225	20.00	9.10	22.60	10.20	
230907	12x14	230	20.00	9.10	18.00	8.80	
230908	14x15	240	22.60	10.20	23.80	10.40	
230909	14x17	250	22.60	10.20	26.50	10.60	
230910	16x17	255	25.20	9.80	26.50	10.60	

арт. № art. №	Размер Size (mm)	L (mm)	D <sub>1</sub> (mm)	W <sub>1</sub> (mm)	D <sub>2</sub> (mm)	W <sub>2</sub> (mm)	Баркод Barcode
230911	17x19	260	26.50	10.60	28.60	11.30	
230912	18x19	275	27.00	10.90	28.60	11.30	
230913	20x22	300	30.70	11.00	34.40	12.00	
230915	21x23	315	31.70	12.70	34.90	13.60	
230916	24x27	320	36.80	13.00	40.00	13.90	
230917	25x28	360	36.80	13.30	40.90	14.30	
230918	30x32	375	44.50	15.00	47.50	15.30	

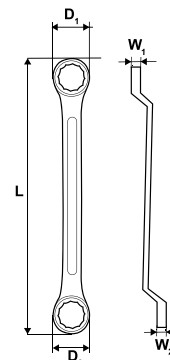

# BI-HEXAGONAL RING SPANNERS SET

- [BG] Ключове лули комплект • [RO] Set chei inelare cotite • [EL] Πολύγωνα σετ • [PT] Jogo luneta estampadas • [IT] Chiavi anulari a gomito
- [SR] Set hromiranih okastih ključeva • [SI] Garnitura obročnih ključev • [BH] Ključ okasti • [RU] Набор Ключ накидной
- [MK] Клуч за скелиња



арт. № art. №	брой pieces	Размер Size (mm)	Баркод Barcode
235118	8	6-7, 8-9, 10-11, 12-13, 14-15, 16-17, 18-19, 20-22	
235119	12	6-7, 8-9, 10-11, 12-13, 14-15, 16-17, 18-19, 20-22, 21-23, 24-27, 25-28, 30-32	



# FLARE NUT WRENCH

- [BG] Ключ срязан • [RO] Cheie inelara pentru tevi • [EL] Πολύγωνα κοφτό • [PT] Chave especial porcas • [IT] Chiave fissa esagonale
- [SR] Ključ okasti otvoreni • [SI] Obročni ključ, odprti • [BH] Ključ • [RU] Гаечный ключ • [MK] Отворен окаст клуч



арт. № art. №	S <sub>1</sub> (mm)	S <sub>2</sub> (mm)	L (mm)	B <sub>1</sub> (mm)	A <sub>1</sub> (mm)	B <sub>2</sub> (mm)	A <sub>2</sub> (mm)	C <sub>1</sub> (mm)	C <sub>2</sub> (mm)	E (mm)	Баркод Barcode
234906	8	10	143	17.5	6.5	19.5	7.5	6.2	7.2	3.3	
234907	9	11	145	17.8	7.5	20.5	8.5	6.4	8.5	3.4	
235173	12	13	165.7	22.5	8.1	25.6	9.5	9.1	10.5	3.6	
230168	13	14	173	25.4	9.3	28.7	10.5	12.3	11.2	4.2	
234905	15	17	195.2	29.3	10.7	30.3	11.8	13.2	14.2	5.7	
230170	16	18	203	31.6	11.8	33.4	12.9	14.3	15.8	6.6	

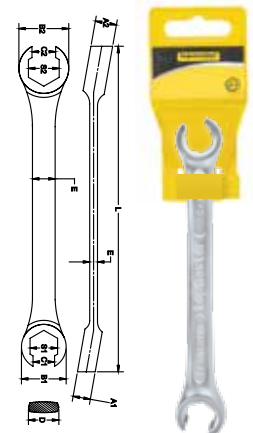

# SLOGGING RING END WRENCH

- [BG] Ключ усилен • [RO] Cheie inelara de impact • [EL] Πολύγωνο σφύρας • [PT] Chave mista • [IT] Chiave
- [SR] Ključ jednostrani okasti udarni • [SI] Ključ • [BH] Ključ • [RU] Гаечный ключ • [MK] Комбиниран окаст клуч

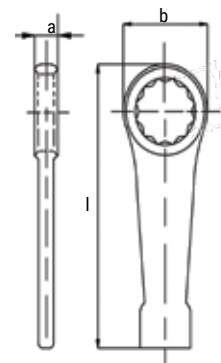

арт. № art. №	Размер Size (mm)	l (mm)	b (mm)	a (mm)	Баркод Barcode
230147	24	160	41	15	
230148	27	185	47	15	
230149	30	190	51	16.5	
230150	32	195	54	16.5	
230152	36	210	60	20	
230154	41	225	66	20	
230155	46	240	74	22	
230156	50	250	80	23	

арт. № art. №	Размер Size (mm)	l (mm)	b (mm)	a (mm)	Баркод Barcode
230157	55	270	86	25	
230158	60	270	92	25	
230159	65	290	100	30	
230160	70	310	108	32	
230161	75	330	115	34	
230162	80	360	126	37	
230163	85	365	130	38	



# SWEDISH TYPE PIPE WRENCH

- [BG] Тръбен ключ • [RO] Cleste tevi tip suedeze • [EL] Τσιμπίδα υδραυλικών • [PT] Alicates de griffes • [IT] Pinza svedese
- [SR] Klešta švedska vodovodna • [SI] Cevne kleščice • [BH] Klješta • [RU] Ключ трубный • [MK] Клешта за цевки

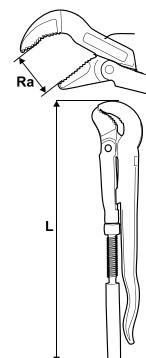

арт. № art. №	L (mm)	Ra (mm)	Weight (kg)	Баркод Barcode
290515	330	40/1"	0.99	
290516	425	55/1.5"	1.55	
290517	535	67/2"	2.40	



## SWEDISH TYPE PIPE WRENCH

- [BG] Тръбен ключ • [RO] Cleste tevi tip suedez • [EL] Τσιμπίδα υδραυλικών • [PT] Alicates de griffes • [IT] Pinza svedese
- [SR] Klešta švedska vodovodna ravna • [SI] Cevne klešče • [BH] Kliješta • [RU] Ключ трубный • [MK] Клешта за цевки



арт. № art. №	L (mm)	Ra (mm)	Weight (kg)	Баркод Barcode
290522	330	40/1"	0.99	
290523	425	55/1.5"	1.55	
290524	535	67/2"	2.40	

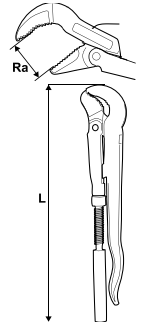

## SWEDISH TYPE PIPE WRENCH

- [BG] Тръбен ключ • [RO] Cleste tevi tip suedez • [EL] Τσιμπίδα υδραυλικών • [PT] Alicates de griffes • [IT] Pinza svedese
- [SR] Klešta švedska vodovodna • [SI] Cevne klešče • [BH] Kliješta • [RU] Ключ трубный • [MK] Клешта за цевки



арт. № art. №	L (mm)	Ra (mm)	Weight (kg)	Баркод Barcode
290510	330	40/1"	0.9	
290511	425	55/1.5"	1.55	
290512	535	67/2"	2.40	

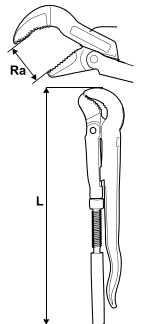

## PIPE WRENCH

- [BG] Тръбен ключ • [RO] Cleste suedez • [EL] Στίλσον κλειδί • [PT] Alicates de griffes • [IT] Pinza svedese
- [SR] Klešta švedska vodovodna • [SI] Cevne klešče • [BH] Kliješta • [RU] Ключ трубный • [MK] Клешта за цевки



Арт. № Art. №	Размер Size (mm)	Баркод Barcode
290501	12 / 300 -3/4"	
290502	14 / 350 -2"	
290503	18 / 450 -2" 1/2	

Арт. № Art. №	Размер Size (mm)	Баркод Barcode
290504	24 / 600 -3"	
290505	36 / 900 -5"	
290506	48 / 1200	

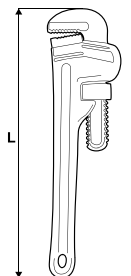



## ADJUSTABLE WRENCH

- [BG] Френски ключ • [RO] Cheie reglabila • [EL] Γαλλικό κλειδί • [PT] Chave inglesa reforçada
- [IT] Chiave regolabile a manico • [SR] Šteljući ključ • [SI] Ključ nastavljivi • [BH] Ključ okasti
- [RU] Ключ разводной • [MK] Ключ со нагодување

Art. № Art. №	L (mm)	Ra (mm)	Баркод Barcode
290907	150	0-22.3	
290908	200	0-28.6	
290909	250	0-32.8	
290910	300	0-38.0	

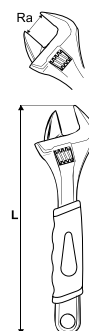

**Cr-V**  
STEEL

## ADJUSTABLE WRENCH

- [BG] Френски ключ • [RO] Cheie reglabila • [EL] Γαλλικό κλειδί • [PT] Chave inglesa reforçada
- [IT] Chiave regolabile a manico • [SR] Šteljući ključ • [SI] Ključ nastavljivi • [BH] Ključ okasti
- [RU] Ключ разводной • [MK] Ключ со нагодување

Art. № Art. №	L (mm)	Ra (mm)	Баркод Barcode
290911	150	0-23	
290912	200	0-28	
290913	250	0-33	



**2<sup>ND</sup>**  
GENERATION

**Cr-V**  
STEEL

## TAP RESEATER

- [BG] Фреза водопроводна • [RO] Freza pentru rectificat scaune obtainer • [EL] Φρέζα μετάλλου • [PT] Fresa para torneira
- [IT] Freza pentru scaune obtainer • [SR] Frezer za slavine • [SI] Povrtalo z nastavki • [BH] Turpija za metal
- [RU] Фреза • [MK] Фреза водоводна

Art. № Art. №	Размер Size (mm)	Баркод Barcode
299901	10, 12, 13, 14, 15, 16	

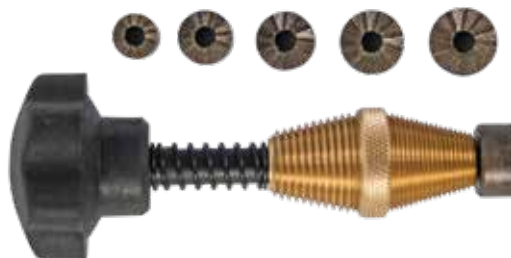

# 3

## ОТВЕРТКИ И НАКРАЙНИЦИ SCREWDRIVERS & BITS



## SCREWDRIVER SLOTTED

- [BG] Отвертка права
- [RO] Surubelnita Phillips
- [EL] Κατσαβίδι ίσιο
- [PT] Chave fendas
- [IT] Cacciavite
- [SR] Odvijač pljosnati BI drška
- [SI] Ploščati izvijač
- [BH] Izvijač ploščati
- [RU] Отвертка плоская
- [MK] Одвртувач плосат

арт. № art. №	⊖ (mm)	L (mm)	L1 (mm)	∅ (mm)	Баркод Barcode
221588	3.0	170	100	3	
221561	4.0	180	100	4	
221562	5.5	180	75	5	
221563	5.5	205	100	5	
221564	5.5	230	125	5	
221566*	6.5	100	38	6	
221565	6.5	270	150	6	
221589	8.0	325	200	7	



Art. No 221566\*

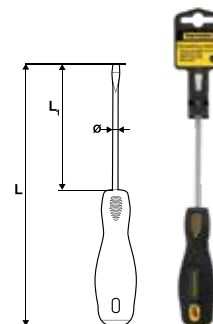

## SCREWDRIVER PHILLIPS

- [BG] Отвертка кръстата
- [RO] Surubelnita stea
- [EL] Κατσαβίδι σταυρού
- [PT] Chave philips
- [IT] Cacciavite a stella
- [SR] Odvijač krstasti BI drška
- [SI] Križni izvijač
- [BH] Izvijač rh
- [RU] Отвертка
- [MK] Одвртувач крстач

арт. № art. №	⊕ (mm)	L (mm)	L1 (mm)	∅ (mm)	Баркод Barcode
221571	PH0	150	75	3	
221567	PH1	205	100	5	
221568	PH1	225	125	5	
221570*	PH2	100	38	6	
221569	PH2	240	125	6	
221590	PH3	325	200	8	



Art. No 221570\*

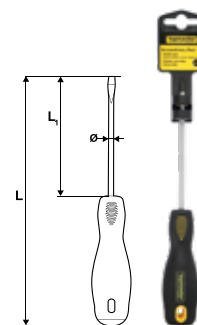

# SCREWDRIVER POZIDRIV

- [BG] Отвертка Pozidriv • [RO] Surubelnita pozidrive • [EL] Κατσαβίδι Pozidriv • [PT] Chave pozidrive Pz 0 • [IT] Cacciavite pozi Pz0
- [SR] Odvijač krstasti PZ • [SI] Križni izvijač • [BH] Izvijač pz • [RU] Отвертка Pz0 • [MK] Одвртувач крстач "Pz0"

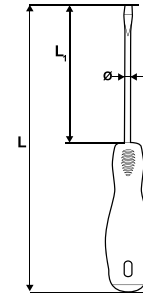

арт. № art. №	⊕ (mm)	L (mm)	L1 (mm)	Ø (mm)	Баркод Barcode
221585	PZ0	150	75	3	
221586	PZ1	200	100	5	
221587	PZ2	215	100	6	



# SET SCREWDRIVER

- [BG] Отвертки комплект • [RO] Surubelnite set • [EL] Κατσαβίδια σετ • [PT] Jogo chaves fenadas • [IT] Cacciaviti set
- [SR] Set odvijača • [SI] Komplet izvijačev • [BH] Izvijač set • [RU] Набор отвёрток • [MK] Гарнитура одвртувачи



арт. № art. №	Баркод Barcode
225107	

3.0x100mm  
5.5x125mm  
6.5x150mm



PH1x100mm  
PH2x38mm  
PH2x125mm







## SCREWDRIVER SLOTTED - 1000V VDE

- [BG] Отвертка изолирана права
- [RO] Surubelnita dreapta izolata
- [EL] Κατσαβίδι ηλεκτρολόγου ίσιο με μόνωση 1000V
- [PT] Chave fendas
- [IT] Cacciavite isolata
- [SR] Odvijač pljosnati izolovani
- [SI] Ploščati izvijač
- [BH] Izvijač
- [RU] Отвертка плоская
- [MK] Одвртувач плоснат



арт. № art. №	⊖ (mm)	L (mm)	L1 (mm)	∅ (mm)	Баркод Barcode
220112	3.0	175	100	3	
220113	4.0	205	100	4	
220114	5.5	230	125	5	

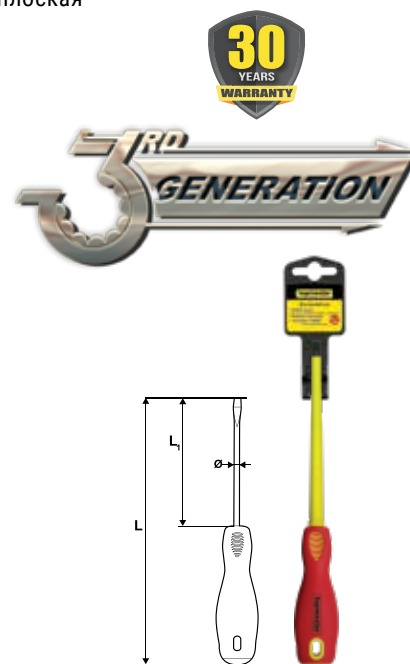

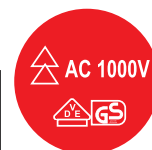

EN 60700:2004



## SCREWDRIVER PHILLIPS 1000V VDE

- [BG] Отвертка изолирана кръстата
- [RO] Surubelnita Phillips izolata
- [EL] Κατσαβίδι ηλεκτρολόγου σταυρού με μόνωση 1000V
- [PT] Chave philips
- [IT] Cacciavite a croce isolata
- [SR] Odvijač krstasti izolovani
- [SI] Križni izvijač za elektriko
- [BH] Izvijač
- [RU] Отвертка крестовая
- [MK] Одвртувач крстач



арт. № art. №	⊕ (mm)	L (mm)	L <sub>1</sub> (mm)	∅ (mm)	Баркод Barcode
220115	PH0	135	60	3	
220116	PH1	170	80	3	
220117	PH2	215	100	6	

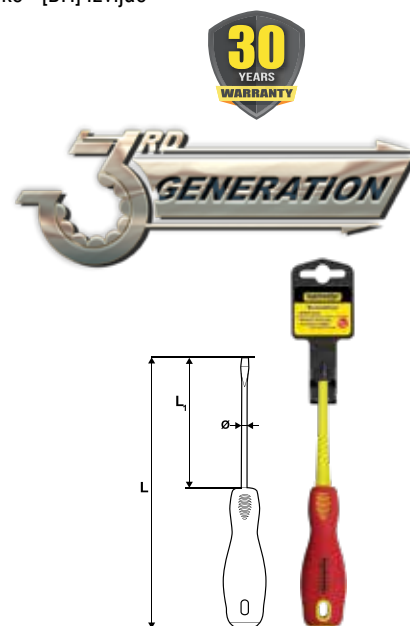

EN 60700:2004



# SCREWDRIVER COMBO PZ ST - 1000V VDE

- [BG] Отвертка изолирана Combo • [RO] Surubelnita combo PZ ST izolata
- [EL] Κατσαβίδι ηλεκτρολόγου PZ/S με μόνωση 1000V
- [PT] Chave Combo • [IT] Cacciavite isolata • [SR] Odvijač kombinovani PZ/Ravni
- [SI] Križni izvijač za električno • [RU] Отвертка • [MK] Одвртувач Combo



ТЪНЪК ПРОФИЛ SLIM PROFILE

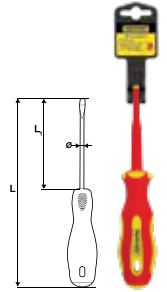
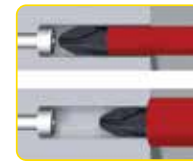

Art. № Art. №	Размер Size (mm)	L (mm)	L <sub>1</sub> (mm)	Ø (mm)	Баркод Barcode
220100	PZ1/ST	190	80	5	
220101	PZ2/ST	215	100	6	



# INTERCHANGEABLE TORQUE SCREWDRIVER VDE

- [BG] Динамометрична отвертка изолирана с накрайници к-т • [RO] Set surubelnite izolate dinamometrice
- [EL] Κατσαβίδι δυναμόκλειδο με μύτες PZ/S σετ με μόνωση VDE 1000V • [PT] Chave de fenda de torque intercambiável set
- [IT] Cacciavite di coppia intercambiabile set • [SR] Set odvijača kombinovanih PZ/Ravni
- [SI] Set izvijačev z izmenljivim navorom • [RU] Набор VDE Динамометрическая Отвёртка С Битами
- [MK] Гарнитура изолирани одвртувачи



- Limits the torque applied with a patented release mechanism
- May be used for uncontrolled wrenching like a regular screwdriver, as long as the torque does not exceed the maximum capacity 5 Nm
- The locking collar prevents accidental change of the torque setting
- +/- 6% clockwise accuracy, fulfills the ISO standard between 1 N-m & 5 N-m, complies with ISO: 6789-2003

Art. № Art. №	Баркод Barcode
220102	

ТЪНЪК ПРОФИЛ SLIM PROFILE



- 3.0 x 60 mm
- 4.0 x 80 mm
- 5.5 x 80 mm
- 6.5 x 100 mm
- PH1 x 80 mm
- PH2 x 100 mm
- COMBO / SLIM PZ/SL 1 x 80 mm
- PZ/SL 2 x 100 mm
- 1 x fully insulated torque handle



## SET SCREWDRIVER 1000V VDE

- [BG] Отвертки изолирани комплект • [RO] Set surubelnite izolate • [EL] Κατσαβίδι ηλεκτρολόγου σετ με μόνωση 1000V • [PT] Jogo
- [IT] Cacciaviti isolati • [SR] Set odvijača izolovanih • [SI] Komplet izvijačev • [BH] Izvijač za natikače • [RU] Отвертки
- [MK] Гарнитура одвртувачи



арт. № Баркод  
art. № Barcode

220120 

EN 60700:2004

3.0x100mm  
4.0x100mm  
5.5x150mm  
AC Tester 110-550V



## INTERCHANGABLE SCREWDRIVER 1000V VDE

- [BG] Отвертка изолирана с крайници комплект • [RO] Set surubelnite izolate interschimbabile
- [EL] Κατσαβίδι με μύτες σετ με μόνωση VDE 1000V • [PT] Jogo • [IT] Cacciaviti isolati • [SR] Set odvijača izolovanih
- [SI] Komplet izvijačev • [BH] VDE izvijač set • [RU] Набор VDE отвёртка с битами • [MK] Гарнитура одвртувачи со битови



арт. №  
art. №

Size (mm)



Баркод  
Barcode

225109  
3 x 100  
4 x 100  
5.5 x 100  
6.5 x 100

Ph2 x 100  
Ph1 x 80

Pz2 x 100  
Pz1 x 80

T20 x 100  
T15 x 100  
T10 x 100



## SCREWDRIVER SLOTTED - 1000V VDE

**NEW**

- [BG] Отвертка изолирана права • [RO] Surubelnita dreapta izolata • [EL] Κατσαβίδι ηλεκτρολόγου ίσιο με μόνωση 1000V • [PT] Chave fendas
- [IT] Cacciavite isolata • [SR] Odvijač plojsnati izolovani • [SI] Ploščati izvijač • [BH] Izvijač • [RU] Отвертка плоская • [MK] Одвртувач плосат

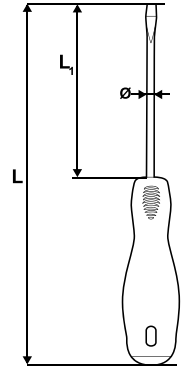

Арт. № Art. №		L (mm)	L <sub>1</sub> (mm)	Баркод Barcode
220130	3	175	100	
220131	4	205	100	
220132	5.5	230	125	

EN 60700:2004



## SCREWDRIVER PHILLIPS 1000V VDE

**NEW**

- [BG] Отвертка изолирана кръстата • [RO] Surubelnita Phillips izolata • [EL] Κατσαβίδι ηλεκτρολόγου σταυρού με μόνωση 1000V • [PT] Chave philips
- [IT] Cacciavite a croce isolata • [SR] Odvijač krstasti izolovani • [SI] Križni izvijač za elektriko • [BH] Izvijač • [RU] Отвертка крестовая • [MK] Одвртувач крстач

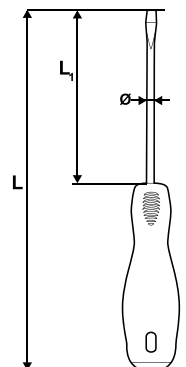

Арт. № Art. №		L (mm)	L <sub>1</sub> (mm)	0	Баркод Barcode
220133	PH0	135	60	3	
220134	PH1	170	80	3	
220135	PH2	215	100	6	

EN 60700:2004







# INTERCHANGEABLE SCREWDRIVER VDE

NEW

- [BG] Отвертка изолирана с накрайници комплект • [RO] Set surubelnite izolate interschimbabile
- [EL] Κατσαβίδι με μύτες σετ με μόνωση VDE 1000V • [PT] Jogo • [IT] Cacciaviti isolati • [SR] Set odvijača izolovanih
- [SI] Komplet izvijačev • [BH] VDE izvijač set • [RU] Набор VDE отвёртка с битами • [MK] Garnitura odvrtuvачи со битови

<b>x8</b>	<b>Cr-V</b> STEEL	<b>MAGNET</b>	<b>+</b>	<b>-</b>	<b>AC 1000V</b>
арт. №	Size (mm)	Lock keys	Баркод		
art. No	 	type	Barcode		
220139	3x100 4x100 5,5x100	PH1x80 PH2x100	triangle and square		



# SCREWDRIVER SLOTTED

- [BG] Отвертка права • [RO] Surubelnita dreapta • [EL] Κατσαβίδι ίσιο • [PT] Chave fendas • [IT] Cacciavite • [SR] Odvijač pljosnati BI drška
- [SI] Ploščati izvijač • [BH] Izvijač ravni • [RU] Отвертка плоская • [MK] Одвртувач плоснат



арт. №		L	L1	Ø	Баркод
art. №	(mm)	(mm)	(mm)	(mm)	Barcode
221572	3.0	175	100	3	
221573	4.0	180	100	4	
221574	4.0	230	150	4	
221509	5.0	180	75	5	
221510	5.0	205	100	5	
221511	5.0	230	125	5	
221575	5.0	250	150	5	
221533*	6.0	100	38	6	
221576	6.0	205	100	6	
221512	6.0	260	150	6	
221513	8.0	325	200	7	



Art. No 221533\*

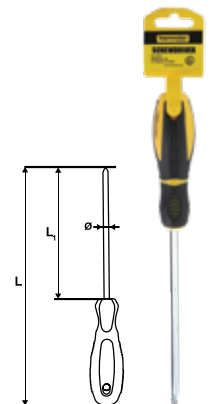

2<sup>ND</sup>  
GENERATION



# SCREWDRIVER PHILIPS

- [BG] Отвертка кръстата • [RO] Surubelnita Phillips • [EL] Κατσαβίδι σταυρού μακρύ • [PT] Chave philips • [IT] Cacciavite a stella
- [SR] Odvijač krstasti BI drška • [SI] Križni izvijač • [BH] Izvijač ph • [RU] Отвертка • [MK] Одвртувач крстач

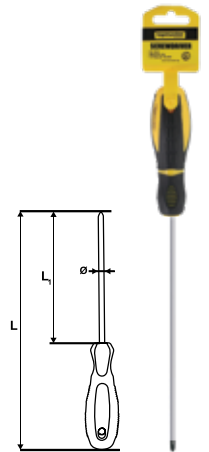

Art. № Art. №	⊕ (mm)	L (mm)	L <sub>1</sub> (mm)	Ø (mm)	Баркод Barcode
221591	PH1	400	300	5	
221592	PH2	414	300	6	
221594	SL5	400	100		



# SCREWDRIVER PHILIPS

- [BG] Отвертка кръстата • [RO] Surubelnita Phillips • [EL] Κατσαβίδι σταυρού • [PT] Chave philips • [IT] Cacciavite a stella
- [SR] Odvijač krstasti BI drška • [SI] Križni izvijač • [BH] Izvijač ph • [RU] Отвертка • [MK] Одвртувач крстач

арт. № art. №	⊕	L (mm)	L <sub>1</sub> (mm)	Ø (mm)	Баркод Barcode
221553	PH0	170	75	3	
221577	PH0	150	100	3	
221578	PH1	180	100	4	
221579	PH1	230	150	4	
221514	PH1	180	75	5	
221515	PH1	205	100	5	
221580	PH1	230	125	5	
221581	PH1	250	150	5	
221534*	PH2	100	38	6	
221582	PH2	205	100	6	
221516	PH2	234	125	6	
221517	PH3	325	200	8	



Art. No 221534\*

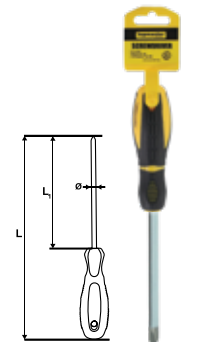

## SCREWDRIVER POZIDRIV

- [BG] Отвертка Pozidriv • [RO] Surubelnita pozidrive • [EL] Κατσάβιδι Pozidriv • [PT] Chave pozidrive Pz0 • [IT] Cacciavite pozi Pz0
- [SR] Odvijač krstasti PZ • [SI] Križni izvijač • [BH] Izvijač pz • [RU] Отвертка Pz
- [MK] Одвртувач крстач Pz



арт. № art. №		L (mm)	L1 (mm)	Ø (mm)	Баркод Barcode
221554	PZ0	170	75	3	
221518	PZ1	180	75	5	
221583	PZ1	205	100	5	
221584	PZ1	230	125	5	
221519	PZ2	205	100	6	
221520	PZ3	275	150	8	

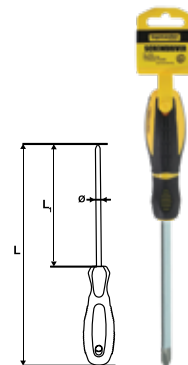

## SET SCREWDRIVER

- [BG] Отвертки комплект • [RO] Set surubelnite • [EL] Κατσάβιδια σετ • [PT] Jogo chaves fenadas • [IT] Cacciaviti set
- [SR] Set odvijača • [SI] Komplet izvijačev • [BH] Izvijač set • [RU] Набор отвёрток • [MK] Гарнитура одвртувачи



арт. № art. №	Баркод Barcode
225106	



3.0 x 75mm  
4.0 x 100mm  
5.5 x 125mm  
6.5 x 150mm

x4 x3

PH0 x 75mm  
PH1 x 100mm  
PH2 x 125mm



# SET SCREWDRIVER

- [BG] Отвертки к-т куфар • [RO] Trusa surubelnite • [EL] Κατσαβίδια σετ • [PT] Jogo parafusos • [IT] Kit cacciaviti set
- [SR] Set odvijača 7 delova kombinovani • [SI] Komplet izvijačev • [BH] Izvijač set • [RU] Набор отвёрток • [MK] Гарнитура одвртувачи



6.0x38mm  
4.0x75mm  
6.0x100mm  
8.0x150mm

⊖ x4 ⊕ x3

Ph2x38mm  
PH1x75mm  
PH2x100mm

Арт. №  
Art. №

Баркод  
Barcode

225104



# SCREWDRIVER SLOTTED

- [BG] Отвертка права • [RO] Surubelnita dreapta • [EL] Κατσαβίδι ίσιο • [PT] Chave fendas • [IT] Cacciavite • [SR] Odvijač plosnati BI дрška
- [SI] Ploščati izvijač • [BH] Izvijač ravni • [RU] Отвертка плоская • [MK] Одвртувач плоснат

арт. № art. №	⊖	L (mm)	L1 (mm)	∅ (mm)	Баркод Barcode
223801*	5.0	103	38	5.0	
223802*	6.0	103	38	6.0	
223803	3.0	155	75	3.0	
223804	3.0	180	100	3.0	
223805	3.0	280	200	3.0	
223806	4.0	180	100	4.0	
223807	4.0	230	150	4.0	
223808	4.0	280	200	4.0	
223809	5.0	175	75	5.0	
223810	5.0	200	100	5.0	
223811	5.0	250	150	5.0	



Art. No 223801\*  
223802\*

223812	6.0	212	100	6.0	
223813	6.0	262	150	6.0	
223814	6.0	312	200	6.0	
223815	8.0	270	150	8.0	
223816	8.0	320	200	8.0	
223817	8.0	370	250	8.0	

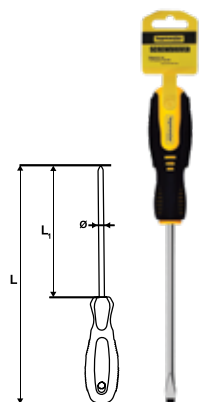







## SCREWDRIVER POZIDRIV

- [BG] Отвертка Pozidriv • [RO] Surubelnita pozidrive • [EL] Κατσαβίδι Pozidriv • [PT] Chave pozidrive Pz0 • [IT] Cacciavite pozi Pz0
- [SR] Odvijač krstasti PZ • [SI] Križni izvijač • [BH] Izvijač pz • [RU] Отвертка Pz
- [MK] Одвртувач крстач Pz



арт. № art. №		L (mm)	L1 (mm)	Ø (mm)	Баркод Barcode
223301	PZ0	155	75	3.0	
223302	PZ1	175	75	5.0	
223303	PZ2	212	100	6.0	

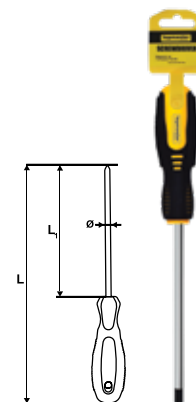

## SCREWDRIVER PHILIPS

- [BG] Отвертка кръстата • [RO] Surubelnita Phillips • [EL] Κατσαβίδι σταυρού • [PT] Chave philips • [IT] Cacciavite a stella
- [SR] Odvijač krstasti BI drška • [SI] Križni izvijač • [BH] Izvijač ph • [RU] Отвертка • [MK] Одвртувач крстач



арт. № art. №		L (mm)	L1 (mm)	Ø (mm)	Баркод Barcode
223201	PH1	103	38	5.0	
223202	PH2	103	38	6.0	
223203	PH0	155	75	3.0	
223204	PH0	180	100	3.0	
223205	PH0	230	150	3.0	
223206	PH1	175	75	5.0	

223207	PH1	200	100	5.0	
223208	PH1	250	150	5.0	
223209	PH2	212	100	6.0	
223210	PH2	262	150	6.0	
223211	PH2	312	200	6.0	
223212	PH3	320	200	8.0	

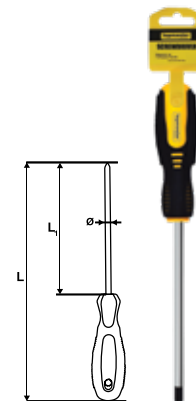

# SCREWDRIVER SET

- [BG] Отвертки комплект • [RO] Set surubelnite • [EL] Κατσαβίδια σετ • [PT] Jogo chaves fenadas • [IT] Cacciaviti set
- [SR] Set odvijača • [SI] Komplet izvijačev • [BH] Izvijač set • [RU] Набор отвёрток • [MK] Гарнитура одвртувачи



арт. № art. №	Баркод Barcode
224501	

3.0 x 100 mm  
5.0 x 100 mm  
6.0 x 150 mm

**⊖ x3** **⊕ x3**

PH0 x 100 mm  
PH1 x 100 mm  
PH2 x 125 mm



# GO - THROUGH SCREWDRIVER

- [BG] Отвертка плоска силова • [RO] Surubelnita dreapta de forta • [EL] Κατσαβίδι ίσιο περαστό • [PT] Chave fendas
- [IT] Cacciavite • [SR] Odvijač pljosnati BI drška udarni • [SI] Ploščati izvijač • [BH] Izvijač ravni
- [RU] Силовая плоская отвёртка • [MK] Одвртувач плоснат

Арт. № Art. №	⊖ (mm)	L <sub>1</sub> (mm)	Баркод Barcode
221601	6	125	
221602	6	150	
221603	8	200	

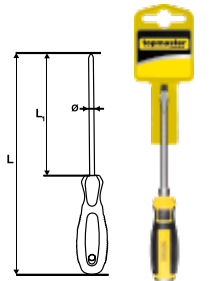

**2<sup>ND</sup>**  
GENERATION



# GO - THROUGH SCREWDRIVER

- [BG] Отвертка кръстата силова • [RO] Surubelnita Phillips de forta • [EL] Κατσαβίδι σταυρού περαστό
- [PT] Chave philips • [IT] Cacciavite a stella • [SR] Odvijač krstasti BI drška udarni • [SI] Križni izvijač
- [BH] Izvijač • [RU] Отвертка крестовая • [MK] Одвртувач крстач

Арт. № Art. №	⊕ (mm)	L <sub>1</sub> (mm)	Баркод Barcode
221604	PH2	125	
221605	PH2	150	
221606	PH3	200	

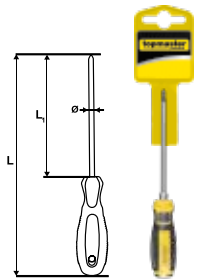

**2<sup>ND</sup>**  
GENERATION



## SET GO - THROUGH SCREWDRIVER

- [BG] Отвертки ударни комплект • [RO] Set surubelnite de forta • [EL] Κατσάβιδια σετ • [PT] Jogo parafusos • [IT] Kit cacciaviti set
- [SR] Set Odvijača udarni • [SI] Komplet izvijačev • [BH] Izvijač set • [RU] Набор силовых отвёрток • [MK] Гарнитура одвртвачи



2<sup>ND</sup>  
GENERATION

Art. №  
Art. №

Баркод  
Barcode

221607



1x100mm  
1x100mm  
1x150mm  
1x150mm

⊖ x4 ⊕ x2 Ph1x100r  
PH2x100i

X6

Cr-V  
STEEL

HEX



## SET GO - THROUGH SCREWDRIVER

- [BG] Отвертки ударни комплект • [RO] Set surubelnite de forta • [EL] Κατσάβιδια σετ • [PT] Jogo parafusos • [IT] Kit cacciaviti set
- [SR] Odvijači kombinovani udarni • [SI] Izvijači za zabijanje • [BH] Izvijač set • [RU] Набор силовых отвёрток • [MK] Гарнитура одвртвачи



Art. №  
Art. №

Баркод  
Barcode

225102



5.0x100mm  
6.0x100mm  
8.0x150mm

⊖ x3 ⊕ x3

PH1x100mm  
PH2x100mm  
PH3x150mm

X6

Cr-V  
STEEL

MAGNET



# SET PRECISION SCREWDRIVERS

• [BG] Отвертка изолирана права • [RO] Surubelnita dreapta izolata • [EL] Κατσαβίδι ηλεκτρολόγου ίσιο με μόνωση 1000V • [PT] Chave fendas • [IT] Cacciavite isolata • [SR] Odnijač pljosnati izolovani • [SI] Ploščati izvijač • [BH] Izvijač • [RU] Отвертка плоская • [MK] Одвртувач плоснат



Art. № Art. №	L (mm)	Баркод Barcode
220103	75	

- 2.5 mm
  Ph0
  T8 T10
- 3.5 mm
  Ph00
  T6 T7
- Straight Pick
  Angle Hook
- Full Hook
  90 Hook

**x12** **Cr-V**  
**STEEL**

# SCREWDRIVER SET 16 IN 1

• [BG] Отвертка с тресчотка 16 в 1 • [RO] Set surubelnita cu clichet • [EL] Κατσαβίδι κασάνια με μύτες • [PT] Set chaves parafusos • [IT] Kit Cacciaviti set • [SR] Set nastavaka sa ručicom • [SI] Komplet izvijačev • [BH] Izvijač set • [RU] Набор отвертка/трещетка • [MK] Повеќенаменски одвртувач

**2<sup>ND</sup>**  
**GENERATION**

mm	mm	mm	mm	mm
8	6.35	156	204	36

mm	mm			
6.35	75	1.0*5	PH1	⊖ ⊕
6.35	75	1.2*6	PH2	⊖ ⊕
8	75	1.2*8.0	PH3	⊖ ⊕
6.35	75	1.5	2	● ●
6.35	75	2.5	3	● ●
6.35	75	4	5	● ●
6.35	75	T15	T20	● ●
6.35	75	T25	T30	● ●



арт. № art. №	Размер Size (inch)	Баркод Barcode
223901	1/4, 5/16	

**REVOLVING** **S2**  
**STEEL**



## HEX DRIVER BIT HOLDER

- [BG] Отвертка за крайници гъвкава • [RO] Maner flexibil pentru tubulare
- [EL] Κατσαβίδι ανταπτορας ευκαμπτος για μύτες • [PT] Chave de bits flexível
- [IT] Manico per tubolare flessibile • [SR] Odvijač za bic nastavke FLEX • [SI] Vpenjalo za nastavke
- [BH] Izvijač sa fleksibilnom glavom • [RU] Отвертка с гибким стержнем • [MK] Одвртувач за битови

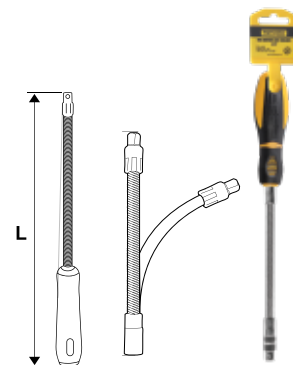



арт. № art. №	L (mm)	Размер Size	Баркод Barcode
223500	274	1/4"	

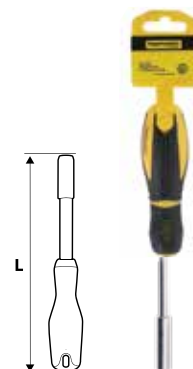
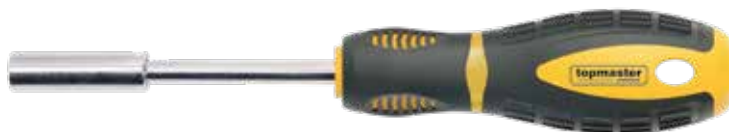

## HEX DRIVER BIT HOLDER

- [BG] Отвертка за крайници • [RO] Maner pentru biti • [EL] Προσαρμογέας μυτών • [PT] • [IT] Manico per bits
- [SR] Odvijač za bit nastavke sa magnetom • [SI] Izvijač nasadni • [BH] Izvijač sa glavom
- [RU] Зажим для наконечников • [MK] Одвртувач за битови



арт. № art. №	L (mm)	Размер Size	Баркод Barcode
221535	180	1/4"	



## SCREWDRIVER TORX

- [BG] Отвертка торкс • [RO] Surubelnita torx • [EL] Κατσαβίδι Torx • [PT] Chave torx • [IT] Cacciavite torx
- [SR] Odvijač Torx • [SI] Torx izvijač • [BH] Izvijač Torx • [RU] Отвертка Torx • [MK] Одвртувач торкс



Арт. № Art. №		L (mm)	Баркод Barcode
221700	T15	5 x 300	
221701	T20	5 x 300	
221702	T25	6 x 300	
221703	T30	6 x 300	



# SET IMPACT SCREWDRIVER

- [BG] Отвертка ударна метална с накрайници комплект • [RO] Set maner impact cu biti • [EL] Κατσαβίδι χτυπητό με μύτες
- [PT] Chave de paracada • [IT] Set maner impact cu biti • [SR] Odvijač udarni • [SI] Izvijači za zabijanje • [BH] Izvijač set
- [RU] Отвёртка гибким стержнем
- [MK] Гарнитура ударен одвртувач



- 2 x 5/16" PH
- 2 x 5/16" Slotted
- 1 x 1/2" Socket Holder

Арт. № Art. №	Баркод Barcode
224906	

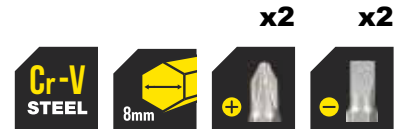

# PHILLIPS BIT

- [BG] Накрайник • [RO] Bit Phillips • [EL] Μύτη σταυρός [PT] Bit • [IT] Impostare bit • [SR] Nastavak PH produženi • [SI] Izvijač
- [BH] Set bitova • [RU] Бит • [MK] Бит

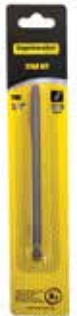

Арт. № Art. №		L (mm)	Баркод Barcode
330482	PH2	150	



# PHILLIPS BIT SET

- [BG] Накрайници комплект • [RO] Set biti Phillips • [EL] Μύτες σταυρού сет • [IT] Impostare bit • [SR] Nastavak PH
- [SI] Set držal križnih • [BH] Set bitova • [RU] Набор бит • [MK] Гарнитура битови

Арт. № Art. №		L (mm)	Баркод Barcode
338700	PH1	25	
338701	PH2	25	
338702	PH3	25	

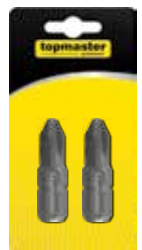

## PHILLIPS BIT SET

- [BG] Накрайници комплект • [RO] Set biti Phillips • [EL] Μύτες σταυρού σετ [PT] Chave bit • [IT] Impostare bit
- [SR] Pin Set • [SI] Set držal križnih • [BH] Set bitova • [RU] Набор бит • [MK] Гарнитура битови

Art. № Art. №	⊕	L (mm)	Баркод Barcode
338703	PH2	25	

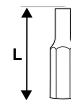

## PHILLIPS BIT SET

- [BG] Накрайници комплект • [RO] Set biti Phillips • [EL] Μύτες σταυρού σετ [PT] Chave bit • [IT] Impostare bit
- [SR] Nastavak PH produženi • [SI] Set držal križnih • [BH] Set bitova • [RU] Набор бит • [MK] Гарнитура битови

арт. № art. №	⊕	L (mm)	Баркод Barcode
338720	PH2	50	



## PHILLIPS BIT SET

- [BG] Накрайници комплект • [RO] Set biti Phillips • [EL] Μύτες σταυρού σετ [PT] Chave bit • [IT] Impostare bit • [SR] Pin Set • [SI] Set držal križnih • [BH] Set bitova • [RU] Набор бит • [MK] Гарнитура битови

арт. № art. №	⊕	L (mm)	Баркод Barcode
338708	PH1	50	
338709	PH2	50	
338710	PH3	50	



**NEW**



## POZIDRIV BIT SET

- [BG] Накрайници комплект • [RO] Set biti pozidrive • [EL] Μύτες Pozidriv σετ [PT] Chave bit • [IT] Impostare bit • [SR] Nastavak PZ
- [SI] Set držal križnih • [BH] Set bitova • [RU] Набор бит • [MK] Гарнитура битови

арт. № art. №	⊕	L (mm)	Баркод Barcode
338704	PZ1	25	
338705	PZ2	25	
338706	PZ3	25	



## POZIDRIV BIT SET

- [BG] Накрайници комплект • [RO] Set biti pozidrive • [EL] Μύτες Pozidriv σετ • [PT] Chave bit • [IT] Impostare bit
- [SR] Nastavak PZ • [SI] Set držal križnih • [BH] Set bitova • [RU] Набор бит • [MK] Гарнитура битови

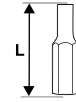

арт. № art. №	⊕	L (mm)	Баркод Barcode
338707	PZ2	25	



## POZIDRIV BIT SET

- [BG] Накрайници комплект • [RO] Set biti pozidrive • [EL] Μύτες Pozidriv σετ • [PT] Chave bit • [IT] Impostare bit • [SR] Pin Set
- [SI] Set držal križnih • [BH] Set bitova • [RU] Набор бит • [MK] Гарнитура битови

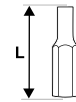

арт. № art. №	⊕	L (mm)	Баркод Barcode
338721	PZ2	50	



## POZIDRIV BIT SET

- [BG] Накрайници комплект • [RO] Set biti pozidrive • [EL] Μύτες Pozidriv σετ • [PT] Chave bit • [IT] Impostare bit • [SR] Pin Set • [SI] Set držal križnih • [BH] Set bitova • [RU] Набор бит • [MK] Гарнитура битов



арт. № art. №	⊕	L (mm)	Баркод Barcode
338711	PZ1	50	
338712	PZ2	50	
338713	PZ3	50	



## STAR BIT

- [BG] Накрайници комплект • [RO] Set biti torx • [EL] Μύτες Torx σετ • [PT] Chave bit • [IT] Impostare bit • [SR] Nastavak TORX
- [SI] Set držal torx • [BH] Set bitova • [RU] Набор бит • [MK] Гарнитура битови

арт. № art. №	⊕	L (mm)	Баркод Barcode
330356	T15	25	
330357	T20	25	
330358	T25	25	
330359	T30	25	

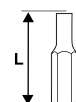



## STAR BIT SET

NEW

• [BG] Накрайници комплект • [RO] Set biti torx • [EL] Μύτες Torx σετ [PT] Chave bit • [IT] Impostare bit • [SR] Nastavak TORX • [SI] Set držal torx • [BH] Set bitova • [RU] Набор бит • [МК] Гарнитура битов

арт. № art. №		L (mm)	Баркод Barcode
338715	T20, T25	50	
338716	2xT30	50	





2<sup>ND</sup>  
GENERATION



## HEX BIT SET

NEW

• [BG] Накрайник шестограм • [RO] Bit imbus lung • [EL] Μύτες σφυροκατσάβιδου άλλεν • [PT] Bits • [IT] Bits • [SR] Nastavak Hex produženi • [SL] Šestkotni nastavak • [BH] Bit • [RU] Шестигранный бит • [МК] Бит нех

арт. № art. №		L (mm)	Баркод Barcode
338714	H5, H6	50	

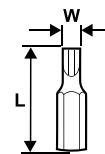

2<sup>ND</sup>  
GENERATION



## NUT SOCKET SET

• [BG] Накрайници за самопробивни винтове комплект • [RO] Set tubulare bit • [EL] Καρυδάκι μαγνητικό • [PT] Bit • [IT] Bit • [SR] Nastavak magnetni nasadni • [SI] Držalo • [BH] Bitov • [RU] Бит • [МК] Бит

Арт. № Art. №	L (mm)	Ø (mm)	Баркод Barcode
338600	42	8 x 1/4"	
338601	42	10 x 1/4"	
338602	42	13 x 1/4"	

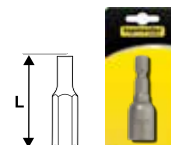

## HEX BIT





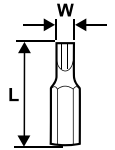

- [BG] Накрайник шестограм • [RO] Bit imbus • [EL] Μύτες σφυροκατσάβιδου άλλεν • [PT] Bits • [IT] Bits • [SR] Nastavak Hex
- [SL] Šestkotni nastavek • [BH] Bit • [RU] Шестигранный бит • [MK] Бит hex

Арт. № Art. №	Размер Size W (mm)	L (mm)	Баркод Barcode
334500	5	30	
334501	6	30	
334502	7	30	
334503	8	30	
334504	10	30	



## HEX BIT

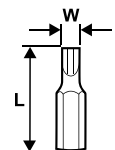

- [BG] Накрайник шестограм • [RO] Bit imbus lung • [EL] Μύτες σφυροκατσάβιδου άλλεν • [PT] Bits • [IT] Bits
- [SR] Nastavak Hex produženi • [SL] Šestkotni nastavek • [BH] Bit • [RU] Шестигранный бит • [MK] Бит hex

Арт. № Art. №	Размер Size (mm)	L (mm)	Баркод Barcode
334506	5	75	
334507	6	75	
334508	7	75	
334509	8	75	
334510	10	75	
334511	12	75	

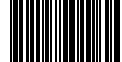

## STAR BIT

- [BG] Накрайник Torx • [RO] Bit Torx • [EL] Μύτες σφυροκατσάβιδου torx • [PT] Bits • [IT] Bits • [SR] Nastavak torx
- [SL] Nastavek zvezda • [BH] Bit • [RU] Торх бит • [MK] Бит torx

Арт. № Art. №	Размер Size (mm)	L (mm)	Баркод Barcode
330391	T25	30	
330392	T30	30	
330393	T40	30	

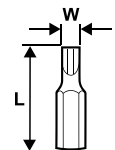

# STAR BIT

- [BG] Накрайник Torx • [BG] Bit Torx lung • [EL] Μύτες σφυροκατσάβιδου torx • [PT] Bits • [IT] Bits • [SR] Nastavak Torx produzeni
- [SL] Nastavek zvezda • [BH] Bit • [RU] Torx бит • [MK] Бит torx

Арт. № Art. №	Размер Size (mm)	L (mm)	Баркод Barcode
330396	T25	75	
330397	T30	75	
330399	T45	75	
330455	T50	75	
330456	T55	75	

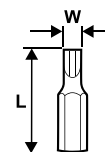

# STAR BIT XZN SET

- [BG] Накрайници XZN комплект • [RO] Set biti Torx XZN • [EL] Μύτες σφυροκατσάβιδου torx карυδάκι сет • [PT] Jogo
- [IT] Proroga Bits set • [SR] Garnitura biceva • [SL] Komplet nastavkov • [BH] Bit set • [RU] Набор XZN Битов • [MK] Битови сет

**Съдържание / Contents**  
 M6, M8, M10 (30mmL);  
 M8, M10, M12 (75mmL);  
 1-bit holder 1/2"(F)x10mm(F)

арт. № art. №	Размер Size	L (mm)	Баркод Barcode
330351	1/2"	3 x 30 3 x 75	

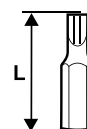

## STAR SOCKET BIT SET

- [BG] Вложки с накрайник комплект • [RO] Set biti tubulara Torx • [EL] Μύτες torx καρυδάκι σετ • [PT] Jogo Bits torx • [IT] Set 4 Bits torx
- [SR] Nastavak TORX na gedori • [SL] Nastavki TORX set • [BH] Bit SET • [RU] Набор сменных головок с наконечниками • [MK] Сет "TORX"

### Съдържание / Contents

☉ x4 1/2" DR. T40, T45, T55, T70 (100 mm)

арт. № art. №	Размер Size	L (mm)	Баркод Barcode
330322	1/2"	100	



## STAR BIT TORX SET

- [BG] Накрайници TORX комплект • [RO] Set biti tubulara Torx • [EL] Μύτες σφυροκατσάβιδου καρυδάκι σετ • [PT] Jogo • [IT] Set Bits torx
- [SR] Garnitura biceva sa magnetnim nastavkom • [SL] Nastavki zvezda • [BH] Bit Set
- [RU] Набор Torx Наконечников • [MK] Сет "TORX"

### Съдържание / Contents

☉ x7 T20; T25; T30; T40; T45; T50; T55  
 ⬠ x1 BIT HOLDER 1/2"DR.X10mm

арт. № art. №	Размер Size	Баркод Barcode
330325	T20-T55	



## STAR BIT SET

- [BG] Накрайници TORX комплект • [RO] Set biti Torx • [EL] Μύτες σφυροκατσάβιδου καρυδάκι σετ • [PT] Jogo • [IT] Set Bits meccanica
- [SR] Nastavci • [SL] Nastavki zvezda • [BH] Bit Set • [RU] Набор Torx Наконечников • [MK] Битови сет

### Съдържание / Contents

- x7: 4, 5, 6, 7, 8, 10, 12mm (30mm)
- x7: 4, 5, 6, 7, 8, 10, 12mm (75mm)
- x5: M5, M6, M8, M10, M12mm (30mm)
- x5: M5, M6, M8, M10, M12mm (75mm)
- x7: T20, T25, T30, T40, T45, T50, T55 (30mm)
- x7: T20, T25, T30, T40, T45, T50, T55 (75mm)
- x2: BIT HOLDER 10mm (3/8" & 1/2")

арт. № art. №	Размер Size	L (mm)	Баркод Barcode
390171	1/2"	20 x 30 20 x 75	





## NUT SOCKET SET

- [BG] Накрайници за самопробивни винтове • [RO] Set tubulare bit • [EL] Καρυδάκι μαγνητικό σετ • [PT] Bit • [IT] Bit
- [SR] Nastavak magnetni nasadni • [SI] Držalo • [BH] Bitov • [RU] Бит • [MK] Битови

Art. № Art. №	L (mm)	Ø (mm)	Баркод Barcode
338603	65	8 x 1/4"	
338604	65	10 x 1/4"	
338605	65	13 x 1/4"	

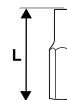

## STAR BIT

- [BG] Накрайник • [RO] Set biti torx • [EL] Μύτες Torx [PT] Bit • [IT] Bit • [SR] Nastavak TORX produženi
- [SI] Držalo torx • [BH] Bitov • [RU] Бит • [MK] Бит

Art. № Art. №		L (mm)	Баркод Barcode
330457	T10	150	
330458	T15	150	
330459	T20	150	
330460	T25	150	

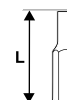

330479	T27	150	
330480	T30	150	
330481	T40	150	



## MAGNETIC BIT HOLDER

- [BG] Удължение за накрайник • [RO] Adaptor magnetic pentru biti • [EL] Αντάπτορας μύτης μαγνητικός
- [PT] Porta bits magnético • [IT] Adattatore magnetico per bits cartongesso • [SR] Magnetni nastavak • [SI] Držalo magnetno
- [BH] Držač bitova • [RU] Удлинитель для бита • [MK] Држач за битови

art. № art. №	L (mm)	Баркод Barcode
330187	60	

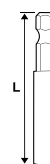

## MAGNETICK BIT HOLDER SET

- [BG] Удължения за накрайник комплект • [RO] Set adaptoare magnetice pentru biti • [EL] Αντάπτορας μύτης μαγνητικός σετ
- [PT] Porta bits magnético • [IT] Adattatore magnetico per bits cartongesso • [SR] Magnetni nastavak • [SI] Držalo magnetno
- [BH] Držač bitova • [RU] Удлинитель для бита • [MK] Држач за битови комплект

art. № art. №	L (mm)	Баркод Barcode
330348	60	



## MAGNETIC BIT HOLDER

- [BG] Удължение за накрайник • [RO] Adaptor magnetic lung pentru biti • [EL] Αντάπτορας μύτης μαγνητικός
- [PT] Porta bits magnético • [IT] Adattatore magnetico per bits cartongesso • [SR] Magnetni nastavak
- [SI] Držalo magnetno • [BH] Držač bitova • [RU] Удлинитель для бита • [MK] Држач за битови

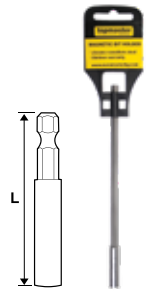

арт. № art. №	L (mm)	Баркод Barcode
330402	175	



## BIT HOLDER WITH CAP

- [BG] Удължение за накрайник с фиксатор • [RO] Adaptor biti prindere rapida • [EL] Αντάπτορας μύτης μαγνητικός
- [PT] Porta bits magnético • [IT] Adattatore magnetico per bits cartongesso • [SR] Magnetni nastavak
- [SI] Držalo magnetno • [BH] Držač bitova magnetni • [RU] Удлинитель для бита • [MK] Држач за битови

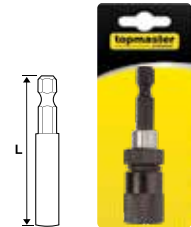

арт. № art. №	L (mm)	Баркод Barcode
330352	60	

За битове с дължина 25 mm  
For bits with length 25 mm



## DRYWALL SCREW

- [BG] Накрайници за монтаж на гипсокартон комплект • [RO] Set biti pentru gips carton • [EL] Μύτες για γυψοσανίδα σετ
- [PT] Set limitador profundidade • [IT] Bits per cartongesso • [SR] Magnetni nastavak za gips PH
- [SI] Set bit-nastavkov komplet • [BH] Izvijae ravni • [RU] Биты для гипсокартона • [MK] Битови сет

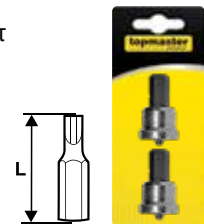

арт. № art. №	⊕	L (mm)	Баркод Barcode
330353	PH2	25	



## PENTA SAFETY HOLE BIT SET

- [BG] Накрайници звезда пет лъча • [RO] Set biti de siguranta • [EL] Σετ μύτες Torx με τρύπα • [PT] Set biti • [IT] Set pezzi bits
- [SR] Set bitseva TORX • [SI] Set držal • [BH] Izvijae • [RU] Биты • [MK] Битови сет



Арт. № Art. №	Size	∅ (mm)	Баркод Barcode
330169	TS8, TS10, TS15, TS20, TS25, TS27, TS30, TS40, TS45, TS50	1/4"	



# HEX KEY

- [BG] Шестограм • [RO] Cheie imbus • [EL] Άλλεν κλειδί • [PT] Chave sextavada interior • [IT] Chiave a brugola • [SR] Ključ imbus
- [SI] Imbus ključ • [BH] • [RU] Ключ шестигранный • [MK] Ключ имбус

арт. № art. №	Ø	L (mm)	L1 (mm)	Баркод Barcode
390159	3	74	20	
390160	4	103	24	
390161	5	115	28	
390162	6	127	32	
390163	7	136	34	
390164	8	75	36	

390165	9	102	38	
390166	10	112	40	
390167	12	124	45	
390168	13	130	50	
390169	14	137	56	
390170	17	158	63	

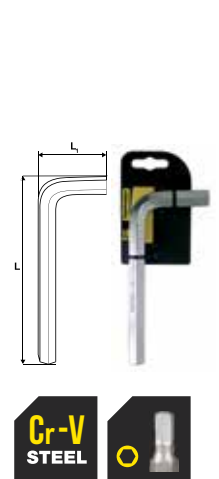

# BALL POINT HEX KEY T-HANDLE

- [BG] Шестограм Т дръжка за работа под ъгъл • [RO] Cheie imbus cu bila manet T
- [EL] Άλλεν ταφ κλειδί • [PT] Chave curtas torx interior c/ bola • [IT] Chiavi a brugola a palla
- [SR] Imbus ključeva sa kuglom • [SI] Imbus ključ okrogli • [BH] Ključ imbus dugi
- [RU] Ключ шестигранный • [MK] Ключ имбус

Арт. № Art. №	Ø	L (mm)	L1 (mm)	Баркод Barcode
390127	2	132	52	
390128	2.5	133	52	
390129	3	133	52	
390130	4	165	60	
390131	5	201	61.5	

390132	6	202	62	
390133	7	229	69	
390134	8	249	76	
390135	10	273	78	

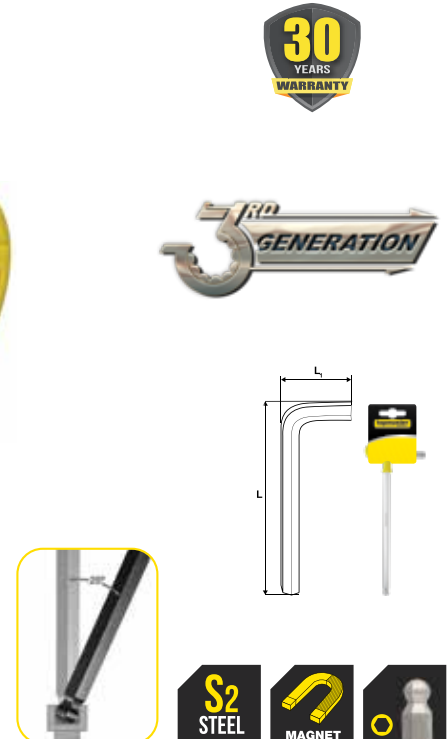

# HEX KEY SET EXTRA LONG (COLOURED)

**NEW**

- [BG] Шестограми комплект • [RO] Set chei imbus • [EL] Άλλεν сет • [PT] Short arm hex key set • [IT] Chiavi a brugola corte set • [SR] Ključ imbus set
- [SI] Garnitura imbus ključev • [BH] Ključ imbus hex • [RU] Ключи шестигранные набор • [MK] Ключ имбус сет

арт. № art. No	Брой в к-т Pcs	Баркод Barcode
390172	1-5-10 mm HEX	9
390173	1-5-10 mm BALL POINT HEX	9
390174	T10-T50 TORX	9



# BALL POINT HEX KEY SET

- [BG] Шестограми за работа под ъгъл • [RO] Set chei imbus cu bila
- [EL] Άλλεν σετ μπίλιας • [PT] Chaves curtas torx interior c/ bola
- [IT] Chiavi a brugola a palla • [SR] Set imbus ključeva sa kuglom • [SI] Garnitura imbus ključev
- [BH] Ključ imbus dugi • [RU] Ключи шестигранные набор • [MK] Ключ имбус

Ø	390119*		390120**		390121***	
	L (mm)	L <sub>1</sub> (mm)	L (mm)	L <sub>1</sub> (mm)	L (mm)	L <sub>1</sub> (mm)
1,5	46	16	70	16	80	17
2	52	18	77	18	77	22
2,5	56	20	85	20	113	25
3	66	22	75	00	130	26
4	76	26	110	26	150	27
5	86	32	125	32	160	37
6	78	36	140	36	163	41
8	108	42	160	42	174	47
10	120	48	180	48	207	50

Арт. №  
Art. №

Баркод  
Barcode

390119\*



390120\*\*



390121\*\*\*



- \* Къси - Short arm
- \*\* Средни - Long arm
- \*\*\* Дълги - Extra Long arm



# TORX HEX KEY SET

- [BG] Шестограми Torx с отвор комплект • [RO] Set chei Torx
- [EL] Άλλεν torx σετ • [PT] Jogo chaves curtas torx interior • [IT] Chiavi a brugola torx set
- [SR] Set TORX ključeva • [SI] Garnitura imbus ključev komplet • [BH] Ključ imbus torks duži
- [RU] Набор шестигранных ключей с отверстиями • [MK] Гарнитура TORX ключеви

Ø	370122*		370123**		370124***	
	L (mm)	L <sub>1</sub> (mm)	L (mm)	L <sub>1</sub> (mm)	L (mm)	L <sub>1</sub> (mm)
T10	46	16	70	16	80	17
T15	52	18	77	18	77	22
T20	56	20	85	20	113	25
T25	66	22	75	00	130	26
T27	76	26	110	26	150	27
T30	86	32	125	32	160	37
T40	78	36	140	36	163	41
T45	108	42	160	42	174	47
T50	120	48	180	48	207	50

Арт. №  
Art. №

Баркод  
Barcode

390122\*



390123\*\*



390124\*\*\*



- \* Къси - Short arm
- \*\* Средни - Long arm
- \*\*\* Дълги - Extra Long arm



# HEX KEY SET

- [BG] Шестограми комплект • [RO] Set chei imbus • [EL] Άλλεν σετ
- [PT] Short arm hex key set • [IT] Chiavi a brugola corte set • [SR] Ključ imbus set
- [SI] Garnitura imbus ključev • [BH] Ključ imbus hex • [RU] Ключи шестигранные набор
- [MK] Ключ имбус сет

Ø	390116		390117		390118	
	L (mm)	L <sub>1</sub> (mm)	L (mm)	L <sub>1</sub> (mm)	L (mm)	L <sub>1</sub> (mm)
1,5	46	16	70	16	80	17
2	52	18	77	18	77	22
2,5	56	20	85	20	113	25
3	66	22	75	00	130	26
4	76	26	110	26	150	27
5	86	32	125	32	160	37
6	78	36	140	36	163	41
8	108	42	160	42	174	47
10	120	48	180	48	207	50

Арт. №  
Art. №

Баркод  
Barcode

390116\*



390117\*\*



390118\*\*\*



- \* Къси - Short arm
- \*\* Средни - Long arm
- \*\*\* Дълги - Extra Long arm





## TORX HEX KEY SET

- [BG] Шестограми Torx с отвор комплект • [RO] Set Chei Torx • [EL] Άλλεν Torx σετ • [PT] Jogo chaves curtas torx interior
- [IT] Chiavi a brugola torx set • [SR] Set TORX ključeva • [SI] Garnitura imbus ključev komplet • [BH] Ključ inbus torks duži
- [RU] Набор шестигранных ключей с отверстиями TORX • [MK] Гарнитура TORX со имбуси

☼ L (mm) L<sub>1</sub> (mm)

T10	84	17
T15	86	17
T20	73	21
T25	77	23
T27	101	24
T30	107	28
T40	115	31

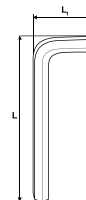

Арт. №  
Art. №

Баркод  
Barcode

390108



## HEX KEY SET

- [BG] Шестограми сгъваеми комплект • [RO] Set chei imbus • [EL] Άλλεν σετ • [PT] Jogo curtas interior
- [IT] Chiavi a brugola set • [SR] Set ključeva • [SI] Garnitura imbus ključev komplet • [BH] Ključ inbus duži
- [RU] Набор шестигранных ключей [MK] Ключ имбус

Арт. №  
Art. №

Размер  
Size (mm)

Баркод  
Barcode

390109

1.5, 2, 2.5, 3, 4, 5, 6, 8



## HEX KEY SET

- [BG] Шестограми сгъваеми комплект • [RO] Set chei imbus • [EL] Άλλεν σετ • [PT] Jogo curtas interior
- [IT] Chiavi a brugola set • [SR] Set ključeva • [SI] Garnitura imbus ključev komplet • [BH] Ključ inbus duži
- [RU] Набор шестигранных ключей [MK] Ключ имбус

Арт. №  
Art. №

Размер  
Size (mm)

Баркод  
Barcode

390100

1.5, 2, 2.5, 3, 4, 5, 6, 8



# 4

КЛЕЩИ  
PLIERS



# HIGH LEVERAGE COMBINATION PLIERS

- [BG] Клещи комбинирани трето поколение • [RO] Cleste combinat • [EL] Πένσα με υπομόχλιο • [PT] Alicates corte lateral
- [IT] Pinza combinata • [SR] Klešta kombinovana • [SL] Kombinirane klešče • [BH] Kliješta kombinovana
- [RU] Комбинированные плоскогубцы третьего поколения • [HR] Kombinacijske kliješta • [MK] Клешта комбинирана

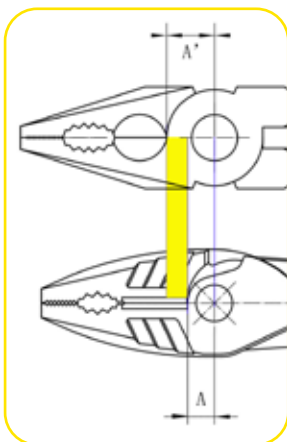

**High leverage** - 35% less effort required than the standard model



**Specially shaped jaws** for firm gripping of nuts & bolts

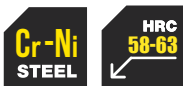
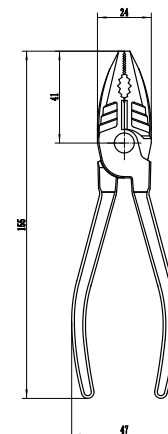

2 times more resistant than Cr-V

Art. № Art. №	Size (mm)	Material	Hardening (HRC)		Cutting capacity (mm)			Баркод Barcode
	Length		Cutting edge	Plier body	Hard wire	Medium hard wire	Soft wire	
210133	160	Cr-Ni	58-63	43-48	2.0	2.2	2.6	
210134	180	Cr-Ni	58-63	43-48	2.2	2.4	2.8	

# HIGH LEVERAGE DIAGONAL CUTTING PLIERS

- [BG] Клещи резачки трето поколение • [RO] Cleste sfic • [EL] Πλαγιόκοφτης με υπομόχλιο • [PT] Alicates de corte lateral
- [IT] Cleste sfic • [SR] Klešta sečice • [SL] Stranske klešče • [BH] Klijesta za rupe • [RU] Кусачки третьего поколения
- [HR] Klijesta za rezanje • [MK] Клешти за сечење

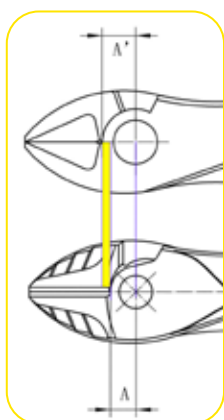

**High leverage** - 35% less effort required than the standard model

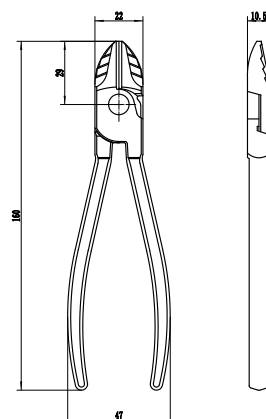

2 times more resistant than Cr-V

Art. № Art. №	Size (mm)	Material	Hardening (HRC)		Cutting capacity (mm)			Баркод Barcode
	Length		Cutting edge	Plier body	Hard wire	Medium hard wire	Soft wire	
210175	160	Cr-Ni	58-63	43-48	2.0	2.2	2.6	



# HIGH LEVERAGE LONG NOSE PLIERS

- [BG] Клещи островърхи трето поколение • [RO] Cleste varf lung • [EL] Μυτοσίμπιδο με υπομόχλιο • [PT] Alicates longo de pontas
- [IT] Pinza a becco appuntito • [SR] Klešta špic prava - BI drška • [SL] Koničaste kleščice • [BH] Klješta stolarska
- [RU] Длинногубцы третьего поколения • [HR] Duga klješta • [MK] Шпицести клешти прави

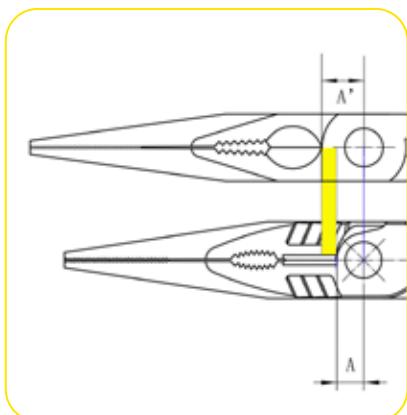

**High leverage** - 35% less effort required than the standard model

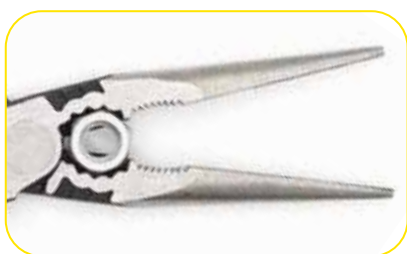

**Specially shaped jaws** for firm gripping of nuts & bolts

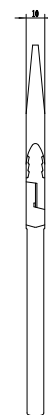
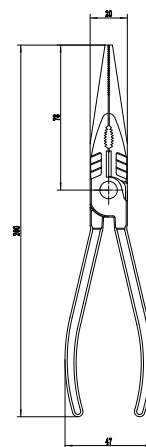

**Cr-Ni**  
STEEL

**HRC**  
58-63

2 times more resistant than Cr-V

Apt. № Art. №	Size (mm)	Material	Hardening (HRC)		Cutting capacity (mm)			Баркод Barcode
	Length		Cutting edge	Plier body	Hard wire	Medium hard wire	Soft wire	
210176	200	Cr-Ni	58-63	43-48	1.6	2.0	2.8	

# HIGH LEVERAGE DIAGONAL CUTTING PLIERS

- [BG] Клещи резачки трето поколение • [RO] Cleste sfic • [EL] Πλαγιοκόφτης με υπομόχλιο • [PT] Alicates de corte lateral • [IT] Cleste sfic
- [SR] Klešta sečice • [SL] Stranske klešče • [BH] Klijesta za rupe • [RU] Кусачки Третьего Поколения • [HR] Cleste sfic • [MK] Клешти за сечење

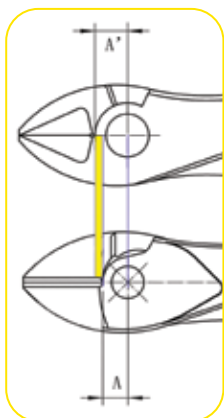

**High leverage -**  
50% less effort required  
than the standard model

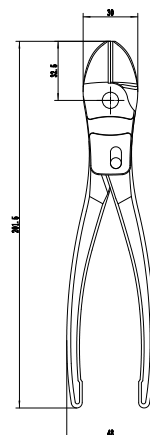

2 times more resistant than Cr-V

Art. № Art. №	Size (mm)	Material	Hardening (HRC)		Cutting capacity (mm)			Баркод Barcode
	Length		Cutting edge	Plier body	Hard wire	Medium hard wire	Soft wire	
210177	210	Cr-Ni	58-63	43-48	2.2	2.4	4.0	

# OFFSET COMBINATION PLIERS

- [BG] Клещи комбинирани с извита глава трето поколение • [RO] Cleste combinat cu cap indoit • [EL] Πένσα πλάγια
- [PT] Offset Alicata Corte Lateral • [IT] Pinza combinata • [SR] Klešta kombinovana kriva • [SL] Koničaste kleščice - urognjene
- [BH] Kombinirana kliješta • [RU] Изогнутые комбинированные плоскогубцы третьего поколения
- [HR] Kombinacijske kliješta • [MK] Комбинирани клешти со закривена глава

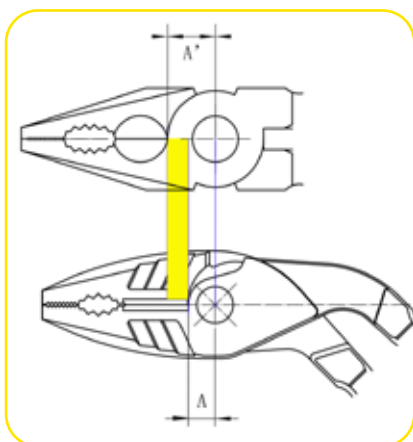

**High leverage** - 35% less effort required than the standard model



**Specially shaped jaws for firm gripping of nuts & bolts**



2 times more resistant than Cr-V



Art. № Art. №	Size (mm)				Material	Hardenig (HRC)		Cutting capacity (mm)			Баркод Barcode
	Length	Head width	Handle width	Thickness		Cutting edge	Plier body	Hard wire	Medium hard wire	Soft wire	
210600	190	27	56	24,5	Cr-Ni	58-63	43-48	2,2	2,6	3	

# OFFSET CUTTING PLIERS

- [BG] Клещи резачки с извита глава трето поколение • [RO] Cleste sfic cu cap indoit • [EL] Πλαγιοκόφτης πλάγιος
- [PT] Offset Alicates De Corte Lateral • [IT] Cleste sfic • [SR] Klešta sečice - BI drška kriva • [SL] Klešče za klešče z ukrivljeno
- [BH] Ofset kliješta za rupu • [RU] Изогнутые кусачки третьего поколения • [HR] Kliješta za rezanje
- [MK] Клешти за сечење со закривена глава

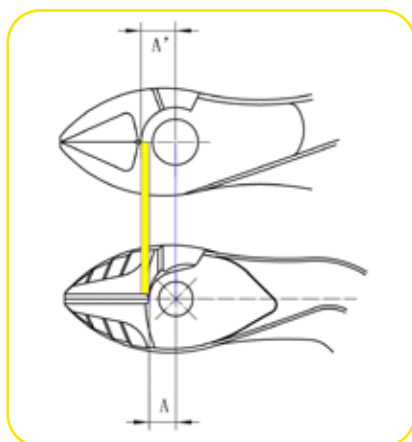

**High leverage** - 35% less effort required than the standard model



2 times more resistant than Cr-V



Art. № Art. №	Size (mm)				Material	Hardenig (HRC)		Cutting capacity (mm)			Баркод Barcode
	Length	Head width	Handle width	Thickness		Cutting edge	Plier body	Hard wire	Medium hard wire	Soft wire	
210100	180	27,5	56	24,5	Cr-Ni	58-63	43-48	1,8	2,0	3,0	



# OFFSET LONG NOSE PLIERS

- [BG] Клещи островърхи с извита глава трето поколение • [RO] Cleste varf lung cu cap indoit • [EL] Μυτοτσίμπιδο πλάγιο
- [PT] Offset Alicates Longo De Pontas • [IT] Pinza a becco appuntito • [SR] Klešta špic prava - BI drška kriva • [SL] Koničaste klešče ukrivljene
- [BH] Ofset klješta stolarska • [RU] Изогнутые длинногубцы третьего поколения • [HR] Duga klješta • [MK] Мултифункционални клешти

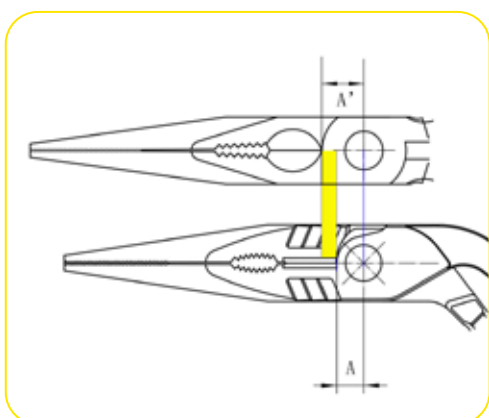

**High leverage** - 35% less effort required than the standard model



**Specially shaped jaws for firm gripping of nuts & bolts**



**Cr-Ni**  
STEEL

2 times more resistant than Cr-V

Apt. № Art. №	Size (mm)				Material	Hardenig (HRC)		Cutting capacity (mm)			Баркод Barcode
	Length	Head width	Handle width	Thickness		Cutting edge	Plier body	Hard wire	Medium hard wire	Soft wire	
210110	200	20	56	24	Cr-Ni	58-63	43-48	1,6	2,2	2,8	

# MULTIFUNCTIONAL LONG NOSE PLIERS

- [BG] Клещи мултифункционални дългоусти трето поколение • [RO] Cleste patent 6 in 1 cu varf lung • [EL] Πένσα πολυλειτουργική Combi
- [PT] Multifuncional Alicata Longo De Pontas • [IT] Multifunzione Pinza a becco appuntito • [SR] Klešta kombinovana višenamenska
- [SL] Kombinirane klešče • [BH] Multifunkcionalan kliješta kombinovana • [RU] Мультифункциональные длинногубцы третьего поколения
- [HR] Višenamjenski Duga kliješta • [MK] Шпицести клешти комбинирани



## ELECTRICAL INSTALLATION ACTIVITIES



Grabbing ①

Cable insulation removal ②

Wire cutting. **High Leverage - 35% less effort required than the standard model** ③

Bolt and nail cutting ④

Reaming ⑤

Wrench ⑥

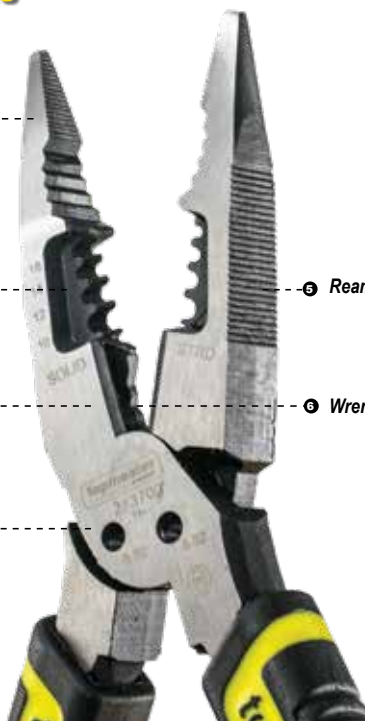
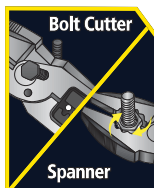

Specially shaped jaws for firm gripping of nuts & bolts

**Cr-Ni**  
STEEL

2 times more resistant than Cr-V

Art. № Art. №	Size (mm)				Material	Hardening (HRC)		Cutting capacity (mm)			Баркод Barcode
	Length	Head width	Handle width	Thickness		Cutting edge	Plier body	Hard wire	Medium hard wire	Soft wire	
213700	210	29	58	17,5	Cr-Ni	58-63	43-48	2,3	2,5	3,0	

# MULTIFUNCTIONAL CUTTING PLIERS

- [BG] Клещи мултифункционални резачки трето поколение • [RO] Cleste sfic multifunctional
- [EL] Πλαγιόκοπτης πολυλειτουργικός Combi • [PT] Multifunctional Alicata De Corte Lateral • [IT] Multifunctional Alicata De Corte Lateral
- [SR] Klešta sečice - BI drška višenamenska [SL] Stranske klešče • [BH] Multifunkcionalan kliješta za rupe
- [RU] Мультифункциональные кусачки третьего поколения • [HR] Višenamjenski Kliješta za rezanje • [MK] Мултифункционални клешти, секачи

**5 IN 1**



**30**  
YEARS  
WARRANTY



## ELECTRICAL INSTALLATION ACTIVITIES

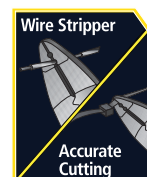
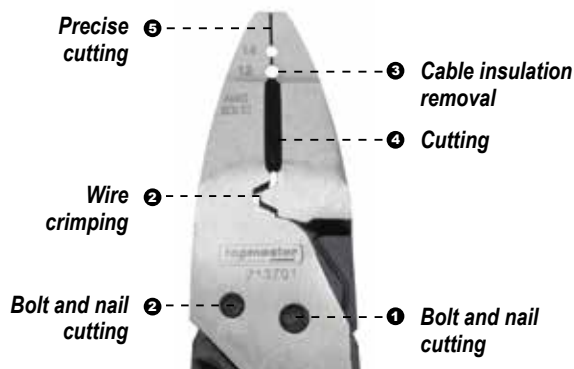

**Cr-Ni STEEL**  
2 times more resistant than Cr-V

Art. № Art. №	Size (mm)	Material	Hardening (HRC)		Cutting capacity (mm)		Баркод Barcode
	Length		Cutting edge	Plier body	Hard wire	Medium hard wire	
213701	190	Cr-Ni	58-63	43-48	1,6	2,0	

## HIGH LEVERAGE COMBINATION PLIERS

- [BG] Клещи комбинирани усилены второ поколение • [RO] Cleste combinat • [EL] Πένσα • [PT] Alta Alavancagem Alicata Corte Lateral
- [IT] Alta Alavancagem Alicata Corte Lateral • [SR] Klešta kombinovana, velike moći • [SL] Kombinirane kleščice
- [BH] Klijesta sječiце porrečne • [RU] Силовые плоскогубцы второго поколения • [HR] Klijesta za rezanje, veća poluga
- [MK] Комбинирани клешти



2<sup>ND</sup>  
GENERATION

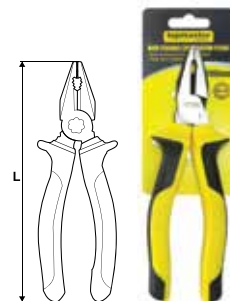

Art. № Art. №	L (mm)	● WIRE Ø mm	● WIRE Ø mm	● WIRE Ø mm	Баркод Barcode
210167	180	1.6	1.8	2.8	
210168	200	2.0	2.4	3.5	

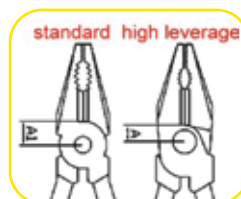

35% less strength

Cr-V  
STEEL

DIN  
5746

HRC  
58-62

## HIGH LEVERAGE DIAGONAL CUTTING PLIERS

- [BG] Клещи резачки усилены второ поколение • [RO] Cleste sfic • [EL] Πλαγιοκόφτης • [PT] Alta Alavancagem Alicata De Corte Lateral
- [IT] Cleste sfic • [SR] Klešta sečiće, velike moći • [SL] Stranske kleščice • [BH] Klijesta kombinovana visoka poluga
- [RU] Силовые кусачки второго поколения • [HR] Klijesta za rezanje, veća poluga • [MK] Клешти за сечење



2<sup>ND</sup>  
GENERATION



art. № art. №	L (mm)	● WIRE Ø mm	● WIRE Ø mm	● WIRE Ø mm	Баркод Barcode
210166	160	1.6	2.0	2.8	

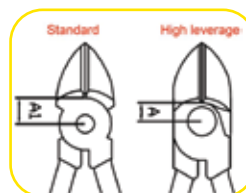

35% less strength

Cr-V  
STEEL

DIN  
5749

HRC  
58-62



## COMBINATION PLIERS

- [BG] Клещи комбинирани • [RO] Cleste combinat • [EL] Πένσα • [PT] Alicates de corte lateral • [IT] Pinza combinata
- [SR] Klešta kombinovana - BI drška • [SL] Kleščice kombinirane • [BH] Kliješta kombinovana visoka poluga • [RU] Комбинированные плоскогубцы
- [HR] Klešta kombinovana - BI drška • [MK] Клешта комбинирана



арт. № art. №	L (mm)	WIRE Ø mm	WIRE Ø mm	Баркод Barcode
210111	160	1.4	1.8	
210112	180	1.6	2.0	
210113	200	1.8	2.2	

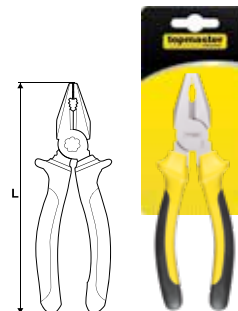

**Cr-V**  
STEEL

**DIN**  
5743

## DIAGONAL CUTTING PLIERS

- [BG] Клещи резачки • [RO] Cleste sfic • [EL] Πλαγιοκόφτης • [PT] Alicates de corte lateral • [IT] Alicates de corte lateral
- [SR] Klešta sečice - BI drška • [SL] Stranske kleščice • [BH] Kliješta za rupu • [RU] Кусачки
- [HR] Kliješta za rezanje • [MK] Клешти за сечење



арт. № art. №	L (mm)	WIRE Ø mm	WIRE Ø mm	Баркод Barcode
210116	160	1.6	2.0	
210117	180	1.8	2.2	

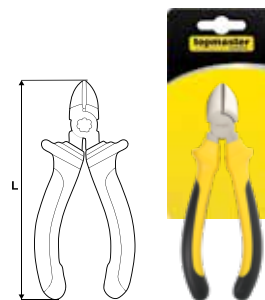

**Cr-V**  
STEEL

**DIN**  
5743

## DIAGONAL CUTTING PLIERS

- [BG] Клещи резачки • [RO] Cleste sfic • [EL] Πλαγιοκόφτης με υπομόχλιο • [PT] Alicates de corte lateral • [IT] Alicates de corte lateral
- [SR] Klešta sečice - BI drška • [SL] Stranske kleščice • [BH] Kliješta za rupu • [RU] Кусачки • [HR] Kliješta za rezanje • [MK] Клешти за сечење



арт. № art. №	L (mm)	WIRE Ø mm	WIRE Ø mm	Баркод Barcode
210118	180	2.0	2.5	

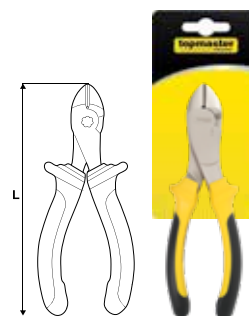

**Cr-V**  
STEEL

**DIN**  
5743

## END NIPPER CUTTING PLIERS

- [BG] Клеши резачки челни • [RO] Cleste taiere frontala • [EL] Κοφτάκι μπέτου • [PT] Alicate de corte • [IT] Cleste sfic taiat fata
- [SR] Klešta čeone sečice - BI drška • [SL] Čelne klešče • [BH] Klijesta sječiце heavy-duty • [RU] Торцевые кусачки особой мощности
- [HR] Klešta čeone sečice - BI drška • [MK] Клешти за сечење

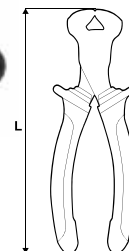

**Cr-V**  
STEEL

**DIN**  
5743

арт. № art. №	L (mm)	● $\frac{\text{WIRE}}{\updownarrow}$ Ø mm	● $\frac{\text{WIRE}}{\updownarrow}$ Ø mm	Баркод Barcode
210120	180	2.2	3.0	
210121	200	3.0	4.0	

## LONG NOSE PLIERS

- [BG] Клеши островърхи • [RO] Cleste varf lung • [EL] Μυτοσίμπιδο • [PT] Alicate longo de pontas
- [IT] Pinza a becco appuntito • [SR] Klešta špic prava - BI drška • [SL] Koničaste klešče • [BH] Klijesta stolarska • [RU] Длинногубцы
- [HR] Duga klijesta • [MK] Шпицести клешти прави

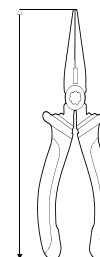

**Cr-V**  
STEEL

**DIN**  
5743

арт. № art. №	L (mm)	● $\frac{\text{WIRE}}{\updownarrow}$ Ø mm	Баркод Barcode
210114	160	1.8	
210115	200	2.0	

## BENT LONG NOSE PLIERS

- [BG] Клеши островърхи извити • [RO] Cleste varf indoit • [EL] Στραβοσίμπιδο • [PT] Alicate de pontas curvas
- [IT] Pinza a becco piegato • [SR] Klešta špic kriva - BI drška • [SL] Klešče telefonske ukrivljene • [BH] Klijesta vodoinstalaterska
- [RU] Загнутые длинногубцы • [HR] Duga klijesta • [MK] Шпицести клешти криви

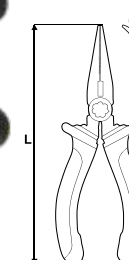

**Cr-V**  
STEEL

**DIN**  
5743

арт. № art. №	L (mm)	● $\frac{\text{WIRE}}{\updownarrow}$ Ø mm	Баркод Barcode
210145	160	1.8	
210146	200	2.0	

## WIRE STRIPPER

- [BG] Клещи за почистване на кабел • [RO] Cleste pentru decablat • [EL] Απογυμνωτής καλωδίων
- [PT] Alicates de escarnar • [IT] Alicates de escarnar • [SR] Klešta za skidanje izolacije - BI drška
- [SL] Kleščice za snemanje izolacije • [BH] Klijesta • [RU] Инструмент Для Удаления Изоляции
- [HR] Klijesta za skidanje izolacije • [MK] Клешти за отстранување изолатија на жица

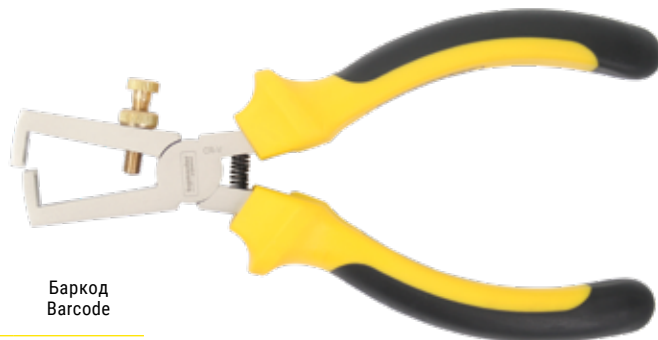

арт. № art. №	L (mm)	WIRE Ø mm	Баркод Barcode
210119	170	5.0	

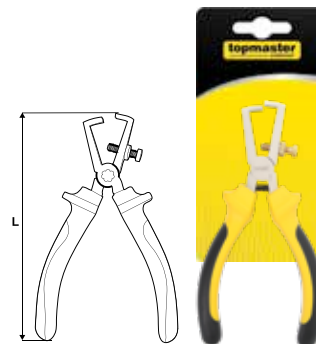

**Cr-V**  
STEEL

**DIN**  
5743

## PRECISE COMBINATION PLIERS

- [BG] Клещи комбинирани • [RO] Mini cleste combinat • [EL] Πένσα μινι • [PT] Alicates reduzido combinado
- [IT] Mini pinza combinata CR-V TMP • [SR] Klešta kombinovana MINI - BI drška • [SL] Kombinirane kleščice
- [BH] Klijesta kombinovana • [RU] Комбинированные плоскогубцы • [HR] Mala klijesta • [MK] Комбинирани клешти



арт. № art. №	L (mm)	WIRE Ø mm	Баркод Barcode
211007	120	1	



**Cr-V**  
STEEL

**DIN**  
5743

## PRECISE DIAGONAL CUTTING PLIERS

- [BG] Клещи резачки • [RO] Mini cleste sfic • [EL] Πλαγιοκόφτης μινι • [PT] Alicates reduzido de corte lateral
- [IT] Mini cleste sfic • [SR] Klešta sečice MINI - BI drška • [SL] Stranske kleščice • [BH] Klijesta mini sječice poprečna
- [RU] Кусачки • [HR] Mini cleste sfic • [MK] Клешти за сечење



арт. № art. №	L (mm)	WIRE Ø mm	Баркод Barcode
211009	110	1	

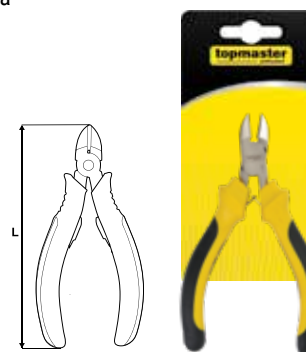

**Cr-V**  
STEEL

**DIN**  
5743

## PRECISE LONG NOSE PLIERS

- [BG] Клещи островърхи • [RO] Mini cleste varf indoit • [EL] Μυτοσίμπιδο μινι • [PT] Alicates reduzido de pontas
- [IT] Mini pinza a becco appuntito • [SR] Klešta špic MINI - BI drška • [SL] Klešče telefonske • [BH] Kliješta mini špicasta duga
- [RU] Длинногубцы • [HR] Mala kliješta, duga • [MK] Шпицести клешти

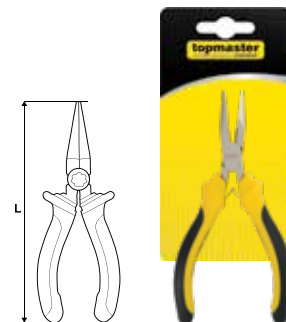

арт. № art. №	L (mm)	WIRE Ø mm	Баркод Barcode
211008	125	1	

**Cr-V**  
STEEL

**DIN**  
5743

## PRECISE END CUTTER PLIERS

- [BG] Клещи резачки челни • [RO] Mini cleste sfic taiat fata • [EL] Κοφτακι μπετου μινι • [PT] Alicates reduzido de corte
- [IT] Alicates reduzido de corte • [SR] Klešta čeone sečice MINI - BI drška • [SL] Stranske klešče, precizne • [BH] Kliješta mini okrugla
- [RU] Торцевые Кусачки • [HR] Klešta čeone sečice MINI - BI drška • [MK] Клешти за сечење

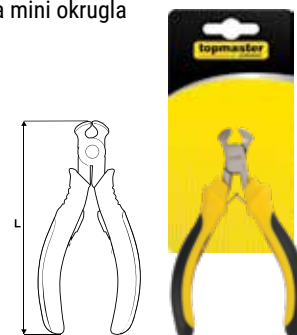

арт. № art. №	L (mm)	WIRE Ø mm	Баркод Barcode
211012	100	1	

**Cr-V**  
STEEL

**DIN**  
5743

## PRECISE NEEDLE NOSE PLIERS

- [BG] Kliješta mini okrugla • [RO] Mini cleste varf ascutit • [EL] Μυτοσίμπιδο μινι • [PT] Alicates reduzido de pontas
- [IT] Mini pinza a becco appuntito • [SR] Klešta špic MINI - BI drška • [SL] Klešče telefonske • [BH] Kliješta mini sječice
- [RU] Длинногубцы • [HR] Mala kliješta, iglasta • [MK] Шпицести клешти

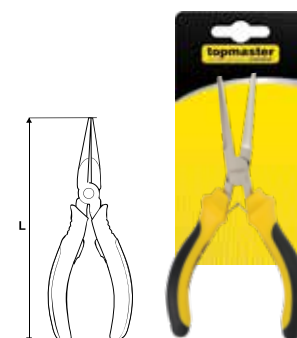

арт. № art. №	L (mm)	Баркод Barcode
211013	150	

**Cr-V**  
STEEL

**DIN**  
5743



## PRECISE BENT NOSE PLIERS

- [BG] Клещи полукръгли извити челюсти • [RO] Mini cleste varf indoits • [EL] Στραβοτσίμπιδο μινι
- [PT] Alicates de pontas curvas • [IT] Mini pinza a becco appuntito • [SR] Klešta špic kriva MINI - BI drška
- [SL] Kleščice telefonske • [BH] Klješta mini špicasta • [RU] Загнутые Длинногубцы
- [HR] Mala klješta, savijena • [MK] Шплицести клешти криви

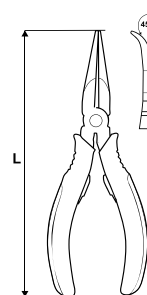
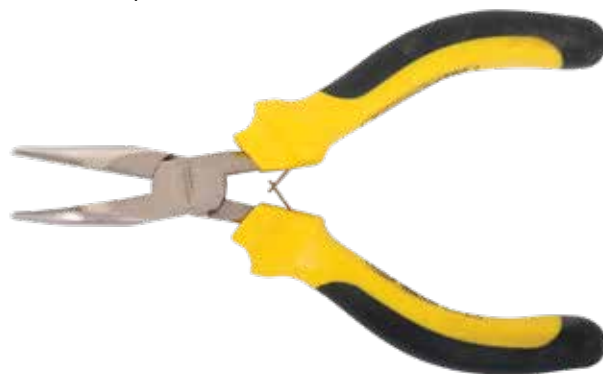

арт. № L Баркод  
art. № (mm) Barcode

211010 125 

**Cr-V**  
STEEL **DIN**  
5743

## PRECISE ROUND NOSE PLIER

- [BG] Клещи мини кръглоусти • [RO] Mini cleste sigurate • [EL] Ασφαλειοτσίμπιδο μινι
- [PT] Alicates reduzido de pontas redondas • [IT] Mini pinza fusibili • [SR] Klešta okrugla MINI - BI drška
- [SL] Kleščice telefonske koničaste • [BH] Klješta mini kombinovana • [RU] Круглые Длинногубцы
- [HR] Duga klješta • [MK] Округли клешти

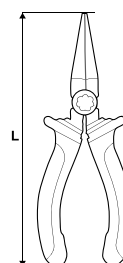

арт. № L Баркод  
art. № (mm) Barcode

211011 125 

**Cr-V**  
STEEL **DIN**  
5743

## PRECISE FLAT NOSE PLIERS

- [BG] Клещи плоски челюсти • [RO] Mini cleste drept • [EL] Πλατυτσίμπιδο μινι • [PT] Alicates reduzido de pontas
- [IT] Mini cleste sfic taiat fata • [SR] Klešta flah MINI - BI drška • [SL] Kleščice telefonske ploščate • [BH] Klješta • [RU] Плоскогубцы
- [HR] Klešta flah MINI - BI drška • [MK] Плоснати клешти

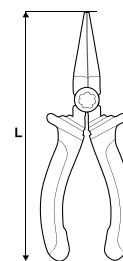

арт. № L Баркод  
art. № (mm) Barcode

211014 125 

**Cr-V**  
STEEL **DIN**  
5743

## COMBINATION PLIERS 1000V VDE

- [BG] Клещи комбинирани изолирани • [RO] Cleste combinate izolat • [EL] Πένσα ηλεκτρολόγου VDE 1000V • [PT] Alicates universal
- [IT] Alicates universal • [SR] Klešta kombinovana izolovana • [SL] Kombinirane kleščice • [BH] Klješta kombinovana vde
- [RU] Комбинированные Плоскогубцы VDE • [HR] Alicates universal • [MK] Комбинирани клешти

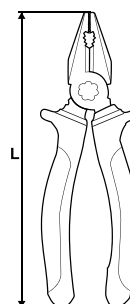

арт. № art. №	L (mm)	WIRE Ø mm	WIRE Ø mm	Баркод Barcode
210401	160	1.4	1.8	
210402	180	1.6	2.0	
210403	200	1.8	2.2	



IEC 60900:2004



## DIAGONAL CUTTING PLIERS 1000V VDE

- [BG] Клещи резачки изолирани • [RO] Cleste sfic izolat • [EL] Πλαγιοκόφτης ηλεκτρολόγου VDE 1000V • [PT] Alicates de corte lateral
- [IT] Alicates de corte lateral • [SR] Klešta sečice izolovana • [SL] Stranske kleščice • [BH] Klješta za rupe vde • [RU] Кусачки VDE
- [HR] Mala klješta za rezanje • [MK] Клешти за сечење

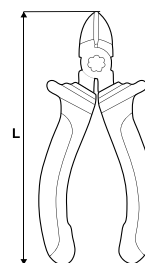

арт. № art. №	L (mm)	WIRE Ø mm	WIRE Ø mm	Баркод Barcode
210406	160	1.6	2.0	



IEC 60900:2004



## HEAVY-DUTY DIAGONAL CUTTING PLIERS 1000V VDE

- [BG] Клещи резачки изолирани усилены • [RO] Cleste sfic heavy-duty • [EL] Πλαγιόκοφτης με υπομόχλιο ηλεκτρολόγου VDE 1000V
- [PT] Alicates de corte lateral lamina endurecida • [IT] Cleste sfic heavy-duty • [SR] Klešta sečice izolovana
- [SL] Stranske klešče • [BH] Mala kliješta za rezanje • [RU] Mala kliješta za rezanje
- [HR] Mala kliješta za rezanje • [MK] Клешти за сечење

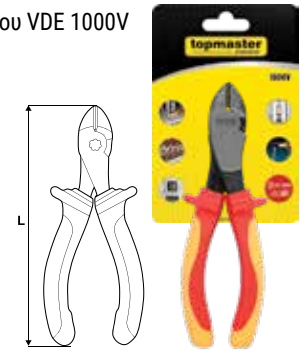

арт. № art. №	L (mm)	WIRE Ø mm	WIRE Ø mm	Баркод Barcode
210407	180	2.0	2.5	

Cr-V  
STEEL

CE

IEC 60900:2004



## LONG NOSE PLIERS 1000V VDE

- [BG] Клещи островърхи изолирани • [RO] Cleste varf lung • [EL] Μυτοτσιμπίδο ηλεκτρολόγου VDE 1000V
- [PT] Alicates de pontas longas • [IT] Alicates de pontas longas • [SR] Klešta špic izolovana • [SL] Klešče telefonske
- [BH] Kliješta stolarska vde • [RU] Длинногубцы VDE • [HR] Duga kliješta • [MK] Шпицести клешти прави



арт. № art. №	L (mm)	WIRE Ø mm	Баркод Barcode
210404	160	1.8	
210405	200	2.0	

Cr-V  
STEEL

CE

IEC 60900:2004



## BENT LONG NOSE PLIERS 1000V VDE

- [BG] Клещи островърхи извити изолирани • [RO] Cleste varf lung indoit • [EL] Στραβοτσιμπίδο ηλεκτρολόγου VDE 1000V
- [PT] Alicates de pontas • [IT] Pinza a becco piegato • [SR] Klešta špic kriva izolovana • [SL] Koničaste klešče - upognjene
- [BH] Kliješta stolarska vde • [RU] Загнутые Длинногубцы VDE • [HR] Duga kliješta • [MK] Шпицести клешти криви

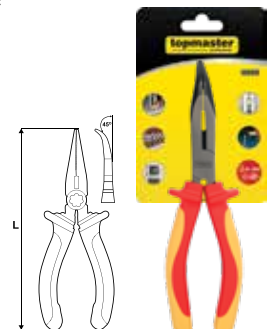

арт. № art. №	L (mm)	WIRE Ø mm	Баркод Barcode
210410	160	1.8	
210411	200	2.0	

Cr-V  
STEEL

CE

IEC 60900:2004



## WIRE STRIPPER 1000V VDE

- [BG] Клещи за почистване на кабел изолирани • [RO] Cleste pentru decablat • [EL] Απογυμνωτής καλωδίων ηλεκτρολόγου VDE 1000V
- [PT] Alicates de descarnar • [IT] Alicates de descarnar • [SR] Klešta blankerice izolovana • [SL] Kleščice za snemanje izolacije • [BH] Kliješta
- [RU] Инструмент Для Удаления Изоляции VDE • [HR] Kliješta • [MK] Клешти за отстранување изолација од жица

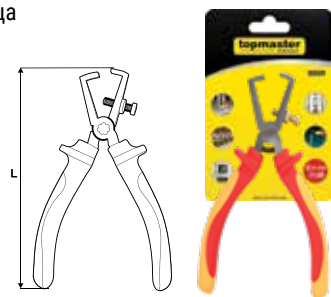

арт. № art. №	L (mm)	WIRE Ø mm	Баркод Barcode
210408	170	5	

CE  
IEC 60900:2004

Cr-V  
STEEL



## PLIERS SET

- [BG] Клещи комплект • [RO] Set clesti • [EL] Σετ πένσα πλαγιοκόφτης μυτοσίμπιδο • [PT] Jogo de 3 alicates
- [IT] Cesti combin./Vf asc./sfic set • [SR] Set klešta kombinivana/sečice/špic • [SL] Kombinirane kleščice, stranske kleščice, telefonske kleščice
- [BH] Cesti combin./Vf asc./sfic set • [RU] Cesti combin./Vf asc./sfic set • [HR] Kliješta • [MK] Гарнитура клешти



арт. № art. №	L (mm)	Баркод Barcode
219908	160	



X3  
Cr-V  
STEEL  
DIN  
5743

## WRENCHES / PLIERS SET

- [BG] Клещи и раздвижен ключ комплект • [RO] Set cleste si chei reglabile • [EL] Σετ πένσα γκαζοτανάλια γαλλικό • [PT] Conjunto 3 ferramentas
- [IT] Cesti comb./instal./cheie regl. • [SR] Set klešta kombinivana/paragajke/štelujući ključ • [SL] Komplet klešč in ključa nastavljivega
- [BH] Kliješta armiračka • [RU] Комплект Плоскогубцев • [MK] Гарнитура клешти со фрнацуски клуч



арт. № art. №	Sizes (mm)		Баркод Barcode
	Wrench	Pliers	
219910	250	250 180	



X3  
Cr-V  
STEEL  
DIN  
5743





# EXTERNAL CIRCLIP PLIERS

- [BG] Клещи зегер прави външни • [RO] Cleste pentru sigurante varf drept EXT • [EL] Ασφαλειοσίμπιδο ίσιο εξωτερικό
- [PT] Alicates pontas retas para freios interiores • [IT] Alicate pontas retas para freios interiores • [SR] Klešta za seger • [SL] Klešče seger
- [BH] Klješta za karike spoljna • [RU] Щипцы для стопорных колец третьего поколения • [MK] Клешти зегер



30  
YEARS  
WARRANTY



арт. № art. №	L (mm)	 Ø mm	 mm	Баркод Barcode
212918	180	1.8	19-60	 3 1800972100563 1

Cr-V  
STEEL

DIN  
5743



# EXTERNAL BENT CIRCLIP PLIERS

- [BG] Клещи зегер извити външни • [RO] Cleste pentru sigurante varf indoit EXT • [EL] Ασφαλειοσίμπιδο κυρτό εξωτερικό
- [PT] Alicates pontas retas para freios interiores • [IT] Alicate pontas retas para freios interiores • [SR] Klešta za seger
- [SL] Klešče seger • [BH] Klješta za karike spoljna • [RU] Щипцы для стопорных колец третьего поколения • [MK] Клешти зегер



30  
YEARS  
WARRANTY



арт. № art. №	L (mm)	 Ø mm	 mm	Баркод Barcode
212919	180	1.8	19-60	 3 1800972100564 8



Cr-V  
STEEL

DIN  
5743

# INTERNAL CIRCLIP PLIERS

- [BG] Клеши зегер прави вътрешни • [RO] Cleste pentru sigurante varf drept INT • [EL] Ασφαλειοσίμπιδο ίσιο εσωτερικό
- [PT] Alicates pontas retas para freios interiores • [IT] Pinza per estrazione fusibile interna/a becco dritto
- [SR] Klešta za seger • [SL] Kleščice seger • [RU] Щипцы для стопорных колец Третьего Поколения
- [HR] Klijesta za karike spoljna • [MK] Клешти зегер



арт. № art. №	L (mm)	 Ø mm	 mm	Баркод Barcode
212920	180	1.8	19-60	



**Cr-V**  
STEEL

**DIN**  
5743

# INTERNAL BENT CIRCLIP PLIERS

- [BG] Клеши зегер извити вътрешни • [RO] Cleste pentru sigurante varf indoit INT • [EL] Ασφαλειοσίμπιδο κυρτό εσωτερικό
- [PT] Alicates pontas retas para freios interiores • [IT] Pinza per estrazione fusibile interna/a becco dritto
- [SR] Klešta za seger • [SL] Kleščice seger • [BH] Klijesta za karike
- [RU] Щипцы для стопорных колец третьего поколения • [MK] Клешти зегер



арт. № art. №	L (mm)	 Ø mm	 mm	Баркод Barcode
212921	180	1.8	19-60	

**Cr-V**  
STEEL

**DIN**  
5743

## INTERNAL CIRCLIP PLIERS

- [BG] Клещи зегер прави вътрешни • [RO] Cleste pentru sigurante INT • [EL] Ασφαλειοσίμπιδο ίσιο εσωτερικό
- [PT] Alicates pontas curvas para freios exteriores • [IT] Pinza per estrazione fusibile esterna/a becco piegato • [SR] Klešta za seger
- [SL] Kleščice seger • [BH] Kliješta za karike • [RU] Щипцы для стопорных колец
- [MK] Клешти зегер



арт. № art. №	L (mm)	Ø mm	mm	Баркод Barcode
212913	180	1.8	19-60	
212911	200	2.1	40-100	



**Cr-V**  
STEEL

**DIN**  
5743

## EXTERNAL CIRCLIP PLIERS

- [BG] Клещи зегер прави външни • [RO] Cleste pentru sigurante EXT • [EL] Ασφαλειοσίμπιδο ίσιο εξωτερικό
- [PT] Alicates pontas retas para freios exteriores • [IT] Pinza per estrazione fusibile esterna/a becco dritto
- [SR] Klešta za seger-spoljna prava • [SL] Kleščice za seger • [BH] Kliješta za karike
- [RU] Щипцы для стопорных колец
- [MK] Клешти зегер



арт. № art. №	L (mm)	Ø mm	mm	Баркод Barcode
212914	180	1.8	19-60	
212912	200	2.1	40-100	



**Cr-V**  
STEEL

**DIN**  
5743

## INTERNAL BENT CIRCLIP PLIERS

- [BG] Клещи зегер извити вътрешни • [RO] Cleste pentru sigurante varf indoit INT • [EL] Ασφαλειοσίμπιδο κυρτό εσωτερικό
- [PT] Alicates pontas curvas para freios interiores • [IT] Pinza per estrazione fusibile interna/a becco piegato • [SR] Klešta za seger
- [SL] Kleščice seger • [BH] Kliješta za karike • [RU] Щипцы для стопорных колец
- [MK] Клешти зегер



арт. № art. №	L (mm)	Ø mm	mm	Баркод Barcode
212916	180	1.8	19-60	
212909	200	2.1	40-100	



**Cr-V**  
STEEL

**DIN**  
5743

## EXTERNAL BENT CIRCLIP PLIERS

- [BG] Клещи зегер извити външни • [RO] Cleste pentru sigurante varf indoit EXT • [EL] Ασφαλειοσίμπιδο κυρτό εξωτερικό
- [PT] Alicates pontas curvas para freios exteriores • [IT] Pinza per estrazione fusibile esterna/a becco piegato
- [SR] Klešta za seger • [SL] Klešče seger • [BH] Kliješta za karike
- [RU] Щипцы для стопорных колец • [MK] Клешти зегер

арт. № art. №	L (mm)	Ø mm	mm	Баркод Barcode
212915	180	1.8	19-60	
212910	200	2.1	40-100	

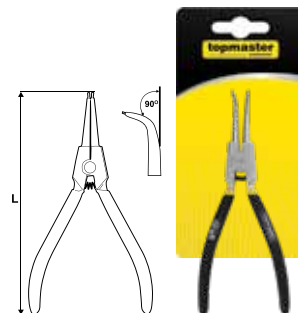

**Cr-V**  
STEEL **DIN**  
5743

## CIRCLIP PLIERS SET

- [BG] Клещи зегер комплект • [RO] Set clesti pentru sigurante • [EL] Ασφαλειοσίμπιδα σετ • [PT] Jogo de 4 alicates de freios
- [IT] Pinze fusibili 6"/150mm set 4 pezzi • [SR] Klešta za seger • [SL] Klešče seger komplet • [BH] Kliješta za izolaciju
- [RU] Щипцы для стопорных колец • [MK] Гарнитура зегер клешти

арт. № art. №	L (mm)	Баркод Barcode
212917	160	



**X4** **Cr-V**  
STEEL **DIN**  
5743

## LONG REACH LONG NOSE PLIER

- [BG] Клещи удължени челюсти • [RO] Cleste varf lung • [EL] Μυτοσίμπιδο μακρύ • [PT] Alicates longo de pontas curvas
- [IT] Pinza meccanica fine • [SR] Klešta špic duga • [SL] Koničaste klešče • [BH] Kliješta topmaster crimp
- [RU] Удлиненные длинногубцы • [HR] Duga kliješta • [MK] Шпицести клешти прави

арт. № art. №	L (mm)	Баркод Barcode
214929	280	

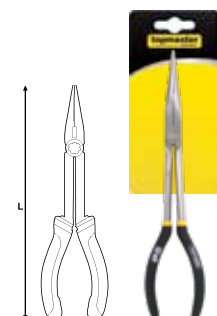

**Cr-V**  
STEEL **DIN**  
5743



## LONG REACH BENT NOSE PLIER

- [BG] Клещи удължени челюсти извити • [RO] Cleste varf lung indoit • [EL] Στραβοτόμπιδο μακρό
- [PT] Alicata longo de pontas curvas • [IT] Pinza meccanica fine a becco piegato • [SR] Klešta špic duga
- [SL] Koničaste kleščice - upognjene • [BH] Kliješta topmaster crimp • [RU] Загнутые Удлиненные Длинногубцы
- [HR] Duga kliješta • [MK] Шпицести клешти криви



арт. № art. №	L (mm)	Ъгъл Angle	Баркод Barcode
214930	280	45°	
214931	280	90°	

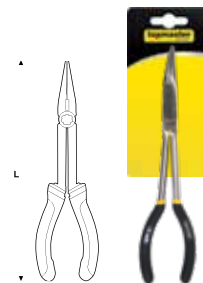

**Cr-V**  
STEEL

**DIN**  
5743

## CARPENTER PINGER

- [BG] Клещи керпеден • [RO] Cleste cuie • [EL] Τανάλια • [PT] Torquês de carpinteiro • [IT] Tenaglia • [SR] Klešta stolarska
- [SL] Mizarske kleščice • [BH] Kliješta stezna • [RU] Плотницкие Клещи • [HR] Kliješta • [MK] Столарски клешти



арт. № art. №	L (mm)	Баркод Barcode
210124	180	
210125	200	

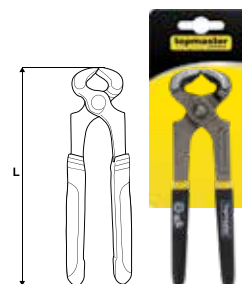

**Cr-V**  
STEEL

**DIN**  
5743

## HIGH LEVERAGE TOWER PINCE

- [BG] Клещи арматурни усиленни • [RO] Cleste cuie lung • [EL] Κόφτης σιδεράτων μακρός • [PT] Turquês
- [IT] Pinza per viti lunghe • [SR] Klešta armiračka, velike moći • [SL] Kleščice za betonske armature
- [BH] Kliješta špicasta • [RU] Силовые Арматурные Клещи • [HR] Kliješta, veća poluga
- [MK] Клешти за армирана жица



арт. № art. №	L (mm)	WIRE Ø mm	WIRE Ø mm	Баркод Barcode
210165	300	2.0	3.0	





**Cr-V**  
STEEL

**HRC**  
58-62

# TOWER PINGER

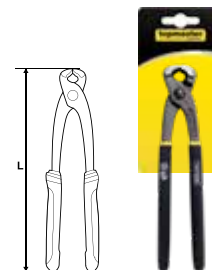
- [BG] Клещи арматурни • [RO] Cleste cuie lung • [EL] Κοφτάκι μπετου μακρυ • [PT] Turquês • [IT] Pinza per viti lunghe • [SR] Klešta armiračka
- [SL] Klešče za betonske armature • [BH] Klamerica • [RU] Арматурные клещи • [HR] Klješta • [MK] Клешти за армирана жица





арт. № art. №	L (mm)	Баркод Barcode
210126	230	
210127	250	

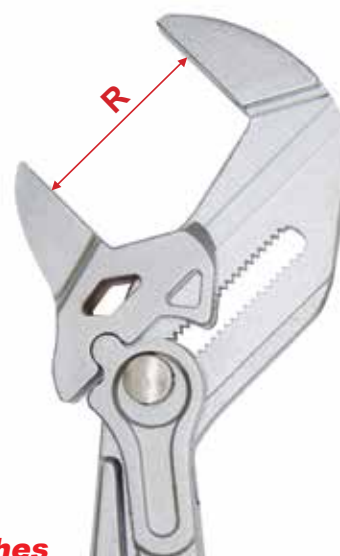

# WRENCH PLIERS

- [BG] Клещи ключ с бутон за регулиране • [RO] Cleste instalator • [EL] Γκαζοσπανάκια • [PT] Alicates ajustável
- [IT] Pinza installatore • [SR] Klešta parapaj • [SL] Klešče univerzalne • [BH] Klješta vodoinstalaterska crna
- [RU] Клещи переставные тип гаечный ключ • [HR] Klješta za vodenu rumpu • [MK] Клешта со копче за нагодување



арт. № art. №	L (mm)	R (mm)	Adjustment positions	Баркод Barcode
210130	250	50	21	

**Substitutes both metric & inch wrenches**



## WATER PUMP PLIERS



- [BG] Клещи тип "Гагра" • [RO] Cleste instalator • [EL] Γκαζοτανάλια • [PT] Alicates ajustável
- [IT] Pinza installatore • [SR] Klešta papagaj • [SL] Kleščice univerzalne • [BH] Klijesta vodoinstalaterska crna
- [RU] Переставной ключ третьего поколения • [HR] Klijesta za vodenu pumpu • [MK] Папагалка

**30**  
YEARS  
WARRANTY

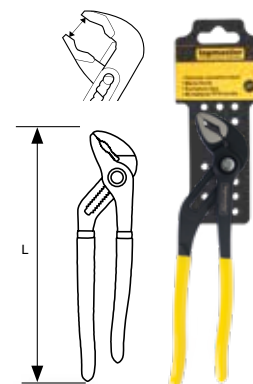

**LOCKING  
function**



арт. № art. №	L (mm)	○]max (mm)	◻]max (mm)	Баркод Barcode
210164	250	49	46	
210169	300	70	60	



## WATER PUMP PLIERS

- [BG] Клещи тип "Гагра" • [RO] Cleste instalator • [EL] Γκαζοτανάλια • [PT] Alicates ajustável
- [IT] Pinza installatore • [SR] Klešta papagaj • [SL] Kleščice univerzalne • [BH] Klijesta vodoinstalaterska crna
- [RU] Переставной ключ третьего поколения • [HR] Klijesta za vodenu pumpu • [MK] Папагалка

**30**  
YEARS  
WARRANTY



**LOCKING  
function**

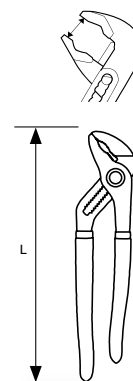

арт. № art. №	L (mm)	○]max (mm)	◻]max (mm)	Баркод Barcode
210170	400	90	95	



# WATER PUMP PLIERS

- [BG] Клещи тип "Гагра" • [RO] Cleste instalator • [EL] Γκαζοπαναλια • [PT] Alicate ajustável • [IT] Pinza installatore
- [SR] Klešta paračaj • [SL] Klešče univerzalne • [BH] Klijesta vodoinstalaterska crna • [RU] Переставной ключ третьего поколения
- [HR] Klijesta za vodenu pumpu • [MK] Папагалка

2<sup>ND</sup>  
GENERATION

**LOCKING  
function**



арт. № art. №	L (mm)	Ra (mm)	Баркод Barcode
211400	200	0-36	
211401	250	0-49	
211402	300	0-59	

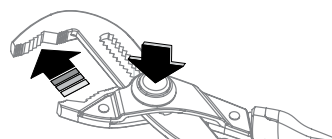

**Cr-V  
STEEL** **DIN  
8976** **17** **HRC  
55-60**

# WATER PUMP PLIERS

- [BG] Клещи тип "Гагра" • [RO] Cleste instalator • [EL] Γκαζοπαναλια • [PT] Alicate ajustável
- [IT] Pinza installatore • [SR] Klešta paračaj • [SL] Klešče univerzalne • [BH] Klijesta vodoinstalaterska crna
- [RU] Переставной ключ третьего поколения • [HR] Klijesta za vodenu pumpu • [MK] Папагалка

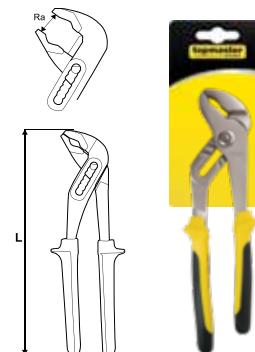

арт. № art. №	L (mm)	Ra (mm)	Баркод Barcode
210122	250	0-36	

**Cr-V  
STEEL** **DIN  
5743**

# WATER PUMP PLIERS

- [BG] Клещи тип "Гагра" • [RO] Cleste instalator • [EL] Γκαζοπαναλια • [PT] Alicate ajustável
- [IT] Pinza installatore • [SR] Klešta paračaj • [SL] Klešče univerzalne • [BH] Klijesta vodoinstalaterska crna
- [RU] Переставной ключ третьего поколения • [HR] Klijesta za vodenu pumpu • [MK] Папагалка

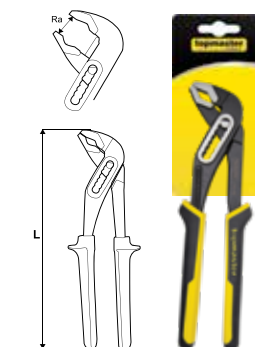

арт. № art. №	L (mm)	Ra (mm)	Баркод Barcode
210156	250	0-36	

**Cr-V  
STEEL**



## AUTO LOCKING PLIERS

- [BG] Клещи чирак автоматични • [RO] Cleste autoblocant • [EL] Αυτόματο υκριπ με μύτη
- [PT] Automático Alicates de pressão • [IT] Pinza di presa autobloccante • [SR] Grip Klešta sa pravim vrhom
- [SL] Prijemne klešče • [BH] Automatski kliješta stezna široka • [RU] Автоматические зажимные клещи
- [HR] Kliješta sa zaključavanjem, zakrivljena čeljust • [MK] Грип клешти

30  
YEARS  
WARRANTY



Арт. № L Баркод  
Art. № (mm) Barcode

210132

180



3 180 097 21003873 1

Cr-V  
STEEL

## LOCKING PLIERS

- [BG] Клещи чирак • [RO] Cleste autoblocant • [EL] Γκριπ • [PT] Alicates de pressão
- [IT] Pinza di presa autobloccante • [SR] Klešta grip sa zakrivljenim vrhom • [SL] Prijemne klešče
- [BH] Kliješta stezna široka • [RU] Зажимные клещи • [HR] Kliješta sa zaključavanjem, zakrivljena čeljust
- [MK] Грип клешти

30  
YEARS  
WARRANTY

2<sup>ND</sup>  
GENERATION



Арт. № L Баркод  
Art. № (mm) Barcode

210131

250



3 180 097 21003804 1

Cr-V  
STEEL

## LOCKING PLIERS

- [BG] Клещи чирак • [RO] Cleste autoblocant • [EL] Γκριπ με μόνωση • [PT] Alicates de pressão
- [IT] Pinza di presa autobloccante • [SR] Klešta grip sa zakrivljenim vrhom • [SL] Prijemne klešče
- [BH] Klijesta stezna široka • [RU] Зажимные клещи • [HR] Klijesta sa zaključavanjem, zakrivljena čeljust
- [MK] Грип клешти

арт. № art. №	L (mm)	Ra (mm)	Баркод Barcode
210153	130	0-34	
210154	180	0-38	
210128	250	0-47	

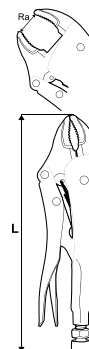

**Cr-V  
STEEL**

## LONG NOSE LOCKING PLIERS

- [BG] Клещи чирак удължени челюсти • [RO] Cleste autoblocant varf lung • [EL] Γκριπ με μύτη & μόνωση
- [PT] Alicates de pressão pontas longas • [IT] Pinza autobloccante a becco appuntito • [SR] Grip Klešta sa pravim vrhom
- [SL] Prijemne klešče • [BH] Klijesta sječice • [RU] Удлиненные зажимные клещи
- [HR] Klijesta sa zaključavanjem, zakrivljena čeljust • [MK] Грип клешти

арт. № art. №	L (mm)	Ra (mm)	Баркод Barcode
210155	150	0-50	
210129	225	0-70	

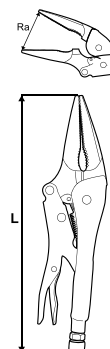

**Cr-V  
STEEL**

## LOCKING PLIERS C - TYPE

- [BG] Клещи чирак "C" форма • [RO] Cleste prindere autoblocant • [EL] Γκριπ δαγκάνα • [PT] Alicates de pressão unir charpa
- [IT] Pinza di presa autobloccante • [SR] Klešta grip C-forma • [SL] Klešče C-spona • [BH] Klijesta sječice
- [RU] Зажимные клещи с фиксатором • [HR] Klijesta sa zaključavanjem, zakrivljena čeljust • [MK] Грип клешта "C" форма

арт. № art. №	L (mm)	Баркод Barcode
213114	275	

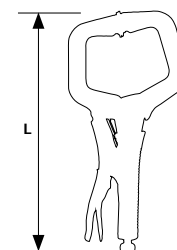

**Cr-V  
STEEL**

## FLAT LOCKIG PLIERS

- [BG] Клещи чирак плоски • [RO] Cleste prindere autoblocant • [EL] Γκριπ δαγκάνα πλατιά • [PT] Alicates de pressão unir chara
- [IT] Pinza di presa autobloccante • [SR] Klešta grip flah • [SL] Prijemne klešče • [BH] Klijesta sječice • [RU] Плоские зажимные клещи
- [HR] Klijesta sa zaključavanjem, zakrivljena čeljust • [MK] Плосната грип клешта

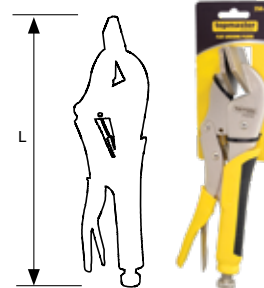

арт. № art. №	L (mm)	Баркод Barcode
213115	230	

**Cr-V**  
STEEL

## CRIMPING PLIERS

- [BG] Клещи кримпващи • [RO] Cleste pentru sertizare • [EL] Πένσα ακροδεκτών • [PT] Alicates de cravar
- [IT] Pinza per aggraffatura • [SR] Klešta za krimpovanje • [SL] Telefonske klešče • [BH] Klijesta armiračka visoka poluga
- [RU] Кримперы • [HR] Klijesta za krimpanje • [MK] Кримп клешта

- RJ-45 8P
- RJ-11/12 6P
- Отстраняване на изолация на плоски кабели
- SK5 резец за прецизно рязане на кабели
- Отстраняване на изолация на CAT.5 UTP кабел



**30**  
YEARS  
WARRANTY



арт. № art. №	L (mm)	Баркод Barcode
211901	200	



Strip CAT.5 cables

Strip cables w/build-in stopper length

Cut cables

Build-in crimp modular for 8P/6P

**SK5**  
STEEL

## CRIMPING PLIERS

- [BG] Клещи кримпващи • [RO] Cleste pentru sertizare • [EL] Πένσα ακροδεκτών • [PT] Alicates de cravar • [IT] Pinza per aggraffatura
- [SR] Klešta za krimpovanje • [SL] Klešče za stiskanje konic • [BH] Klijesta armiračka visoka poluga • [RU] Кримперы
- [HR] Klijesta za krimpanje • [MK] Кримп клешта



арт. № art. №	L (mm)	Баркод Barcode
211902	215	

wire size:  
0.5 - 0.75 - 1 - 1.5 - 2.5 - 4mm<sup>2</sup>  
20-22; 18 - 16; 14-12 AWG



# CRIMPING PLIERS

- [BG] Клещи кримпващи • [RO] Cleste pentru sertizare • [EL] Πένσα ακροδεκτών • [PT] Alicates de cravar • [IT] Pinza per aggraffatura
- [SR] Klešta za krimpovanje • [SL] Kleščice za stiskanje konic • [BH] Klijesta armiračka visoka poluga • [RU] Кримперы
- [HR] Klijesta za krimpanje • [MK] Кримп клешта



арт. №	L	Баркод
art. №	(mm)	Barcode
211903	215	

**wire size:**  
**0.5 - 1 - 1.5 - 2.5 - 4 - 6mm<sup>2</sup>**

# AUTO WIRE STRIPPER PLIERS

- [BG] Клещи за премахане на кабелна изолация • [RO] Cleste pentru decablat • [EL] Απογυμνωτής καλωδίων
- [PT] Alicates de escarnar • [IT] Alicates de escarnar • [SR] Klešta za krimpovanje • [SL] Kleščice za snemanje izolacije
- [BH] Klijesta • [RU] Инструмент Для Удаления Изоляции • [HR] Klijesta za skidanje izolacije
- [MK] Клешти за отстранување изолација на жица



For all types of wire from 10 AWG to 24 AWG gauge (0.2 - 6.0 mm)

Special knob for wire size adjustment

Sliding block for stripping length adjustment

Hardened HQ blades for efficient cuts of copper cables

For insulated terminals

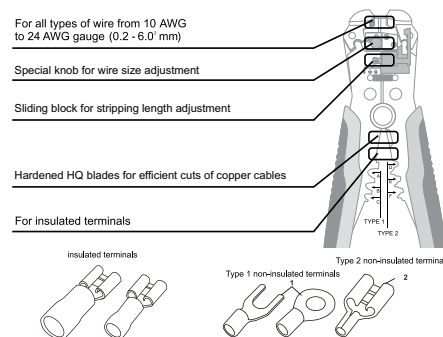

insulated terminals			Type 1 non-insulated terminals			Type 2 non-insulated terminals		
Colour	mm <sup>2</sup>	AWG	Jaw	mm <sup>2</sup>	AWG	Jaw	mm <sup>2</sup>	AWG
Red	0.5-1.5	22-16	A	6.0-8.0	10-8	D	1.5-2.5	16-14
Blue	1.5-4.0	16-14	B	2.5-6.0	14-10	E	0.75-1.5	18-16
Yellow	4.0-6.0	14-12	C	0.5-2.5	22-14	F	0.5-0.75	22-18

**2<sup>ND</sup>**  
**GENERATION**



арт. №	L	Баркод
art. №	(mm)	Barcode
211904	230	

**SK5**  
**STEEL**



## CABLE CUTTER

- [BG] Ножица за рязане на кабел • [RO] Cleste pentru taiere cabluri • [EL] Κόφτης & γδάρτης καλωδίων
- [PT] Alicates de cravar • [IT] Pinza per aggraffatura • [SR] Klešta za sečenje kablova
- [SL] Kleščice za stiskanje konic • [BH] Klješta armiračka visoka poluga • [RU] Кримперы
- [HR] Klješta za krimpiranje • [MK] Клешта за сечење на кабел



арт. № art. №	L (mm)	WIRE Ø mm	Баркод Barcode
371002	170	10.5	



**Double grounded  
cutting blade**

**SK5  
STEEL**

**MAX  
10.5mm**

**AL**

**CU**

## VOLTAGE TESTER AC/DC

- [BG] Тестер - Фазомер • [RO] Tester tensiune electronic • [EL] Δοκιμαστικό κατασβιδι ψηφιακο • [PT] Teste voltagem
- [IT] Tester elettronico tensione • [SR] Tester napona • [SL] Preizkuševalec napetosti
- [RU] Дигитальный фазометр AC / DC • [HR] Ispitivač voltaže, digitalni
- [MK] Дигитален тестер за напон

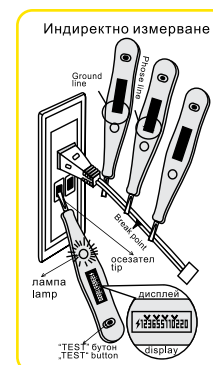

арт. № art. №	Баркод Barcode
281101	



Lamp &  
Induction  
display



Voltage  
display



**AC12-220V  
DC 12-36V**

**Cr-V  
STEEL**



# 5

## ИЗМЕРВАТЕЛНИ ИНСТРУМЕНТИ MEASURING TOOLS



## MAGNETIC MEASURING TAPE

- [BG] Ролетка с магнитен накрайник • [RO] Ruleta • [EL] Μέτρο ρολό • [PT] Fita métrica • [IT] Metro a nastro
- [SR] Metar • [SL] Merilni trak • [BH] Mjerna traka • [RU] Рулетка • [MK] Метро Лента

**SUPER** blade



**2.8m**  
STANDOUT



Art. № Art. №	L (m)	W (mm)	Баркод Barcode
260201	5	27	
260200	8	27	



## MAGNETIC MEASURING TAPE

- [BG] Ролетка с магнитен накрайник • [RO] Ruleta • [EL] Μέτρο ρολό • [PT] Fita métrica • [IT] Metro a nastro
- [SR] Metar • [SL] Merilni trak • [BH] Mjerna traka • [RU] Рулетка • [MK] Метро Лента

**over 3m**  
STANDOUT



Art. № Art. №	L (m)	W (mm)	Баркод Barcode
260202	10	30	





## MEASURING TAPE DOUBLE HOOK

- [BG] Ролетка с двоен накрайник • [RO] Ruleta • [EL] Μέτρο ρολό • [PT] Fita métrica
- [IT] Metro a nastro • [SR] Metar • [SL] Merilni trak • [BH] Mjerna traka • [RU] Рулетка
- [MK] Метро Лента



Art. № Art. №	L (m)	W (mm)	Баркод Barcode
260203	3	16	
260204	5	25	
260205	8	25	



## MEASURING TAPE AUTO STOP

- [BG] Ролетка auto stop • [RO] Ruleta • [EL] Μέτρο ρολό • [PT] Fita métrica • [IT] Metro a nastro
- [SR] Metar • [SL] Merilni trak • [BH] Mjerna traka • [RU] Рулетка • [MK] Метро Лента



Art. № Art. №	L (m)	W (mm)	Баркод Barcode
260610	3	16	
260611	5	19	
260612	5	25	
260613	8	25	

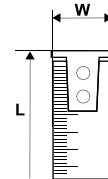

## MEASURING TAPE DOUBLE STOP BLACK EDITION

- [BG] Ролетка двоен стоп • [RO] Ruleta • [EL] Μέτρο ρολό • [PT] Fita métrica • [IT] Metro a nastro • [SR] Metar
- [SL] Merilni trak • [BH] Mjerna traka • [RU] Рулетка • [MK] Метро Лента

Art. № Art. №	L (m)	W (mm)	Баркод Barcode
260550	3	16	
260552	5	25	
260554	8	25	



**BLACK EDITION**

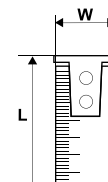



## MEASURING TAPE COMPACT

- [BG] Ролетка • [RO] Ruleta • [EL] Μέτρο ρολό • [PT] Fita métrica • [IT] Metro a nastro • [SR] Metar • [SL] Merilni trak
- [BH] Mjerna traka • [RU] Рулетка • [MK] Метро Лента



Art. № Art. №	L (m)	W (mm)	Баркод Barcode
260401	3	16	
260402	5	19	
260403	5	25	
260600	7,5	25	



the smallest  
MEASURING TAPE



## MEASURING TAPE

- [BG] Ролетка • [RO] Ruleta • [EL] Μέτρο ρολό • [PT] Fita métrica • [IT] Metro a nastro • [SR] Metar • [SL] Merilni trak
- [BH] Mjerna traka • [RU] Рулетка • [MK] Метро Лента

art. № art. №	L (m)	W (mm)	Баркод Barcode
260501	2	16	
260502	3	19	
260503	5	25	
260505	7.5	25	
260504	10	25	

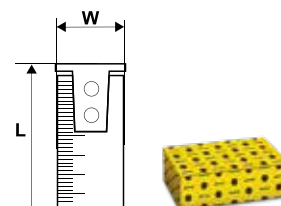

## MEASURING TAPE DOUBLE STOP

- [BG] Ролетка двоен стоп • [RO] Ruleta • [EL] Μέτρο ρολό • [PT] Fita métrica • [IT] Metro a nastro • [SR] Metar
- [SL] Merilni trak • [BH] Mjerna traka • [RU] Рулетка • [MK] Метро Лента

art. № art. №	L (m)	W (mm)	Баркод Barcode
260601	2	16	
260602	3	16	
260603	3	19	
260604	5	19	
260605	5	25	
260606	8	25	

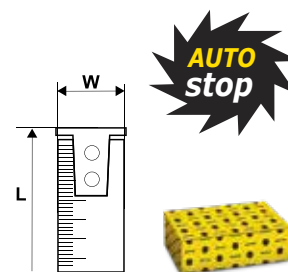

## STEEL MEASURING TAPE

- [BG] Ролетка метален корпус • [RO] Ruleta • [EL] Μέτρο ρολό • [PT] Fita métrica • [IT] Metro a nastro • [SR] Metar • [SL] Merilni trak
- [BH] Mjerna traka • [RU] Рулетка • [MK] Метро Лента

Art. № Art. №	L (m)	W (mm)	Баркод Barcode
260607	3	19	
260608	5	25	
260609	10	25	



2<sup>ND</sup>  
GENERATION

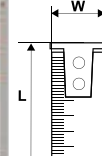

## MEASURING STEEL TAPE

- [BG] Ролетка • [RO] Ruleta • [EL] Μετροταινία • [PT] Fita métrica • [IT] Metro a nastro • [SR] Merna traka • [SL] Merilni trak
- [BH] Mjerna traka • [RU] Рулетка • [MK] Метро Лента

Art. № Art. №	L (m)	Баркод Barcode
261305	50	

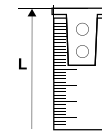

## MEASURING WHEEL

- [BG] Уред за измерване на разстояние • [RO] Roata masurare distante • [EL] Μέτρο με ρόδες μεγάλων αποστάσεων
- [PT] Roda de medição TMP • [IT] Ruota misuratrice distanza TMP • [SR] Merni tocak sa futrolom • [SL] Kolo merilno
- [BH] Mjerna kolica • [RU] Измерительное колесо • [MK] Метро за мерење на растојание

Art. № Art. №	Скала (m)	Дръжка (mm)	Баркод Barcode
289909	9999	420 - 900	



WATERPROOF BAG



## PANTOGRAPH

- [BG] Пантограф • [RO] Conducător flexibil • [EL] Ταντογράφος • [PT] Pantógrafo • [IT] Pantografo
- [SR] Fleksibilna linija • [SL] Odjemnik toka • [BH] • [RU] • [MK] Пантограф

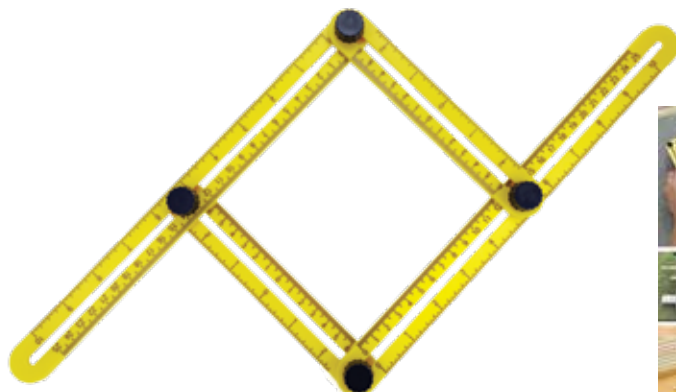

Арт. №  
Art. №

281203



## ALUMINUM PANTOGRAPH

- [BG] Пантограф алуминиев • [RO] Conducător flexibil aluminiu • [EL] Ταντογράφος αλουμίνιο • [PT] Pantógrafo alumínio
- [IT] Pantografo alluminio • [SR] Fleksibilna linija aluminijum • [SL] Odjemnik toka aluminij
- [BH] Pantograf • [RU] Шаблон гибких углов • [MK] Пантограф алуминиев

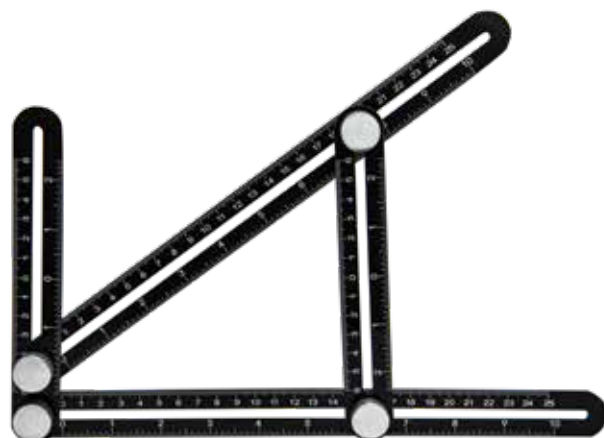

Арт. №  
Art. №

281207

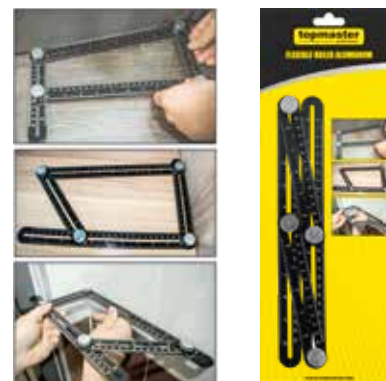

AL

## MICRO METER

- [BG] Микрометър • [RO] Micrometru • [EL] Μικρόμετρο • [PT] Micro medidor • [IT] Micrometro • [SR] Mikrometar • [SL] Mikrometer
- [BH] Mikro metar • [RU] Штангенциркуль проф • [MK] Микрометар



Арт. №  
Art. №

280501

Размер  
Size (mm)

0-25 x 0.01



STAINLESS  
STEEL

±0,01  
mm

## FEELER GAUGE

- [BG] Луфтомер • [RO] Set 20 lere • [EL] Διακενόμετρο • [PT] Papa folgas / Calibrador • [IT] Contafiletta • [SR] Meri listići
- [SL] Kontrolni lističi • [RU] Измерительный щуп • [MK] Мерни листови - Шпиунки



Art. № Art. №	Sizes (mm)	Баркод Barcode
349002	0.05, 0.10, 0.15, 0.20, 0.25, 0.30, 0.35, 0.40, 0.45, 0.50, 0.55, 0.60, 0.65, 0.70, 0.75, 0.80, 0.85, 0.90, 0.95, 1.0	



## STEEL CALLIPER

- [BG] Шублер • [RO] Subler • [EL] Παχύμετρο • [PT] Paquímetro • [IT] Calibro • [SR] Šubler • [SL] Pomerno merilo
- [BH] Šubler • [RU] Штангенциркуль проф • [MK] Метална лизгачка скала - Шублер

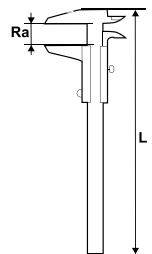

Art. № Art. №	L (mm)	Ra (mm)	Баркод Barcode
280302	235	0-150	
280303	300	0-200	



## DIGITAL CALLIPER

- [BG] Дигитален шублер • [RO] Subler digital • [EL] Παχύμετρο ψηφιακό • [PT] Paquímetro digital • [IT] Calibro digitale
- [SR] Šubler digitalni • [SL] digitalno pomerno merilo • [BH] šubler digitalni • [RU] Цифровой штангенциркуль
- [MK] Метална лизгачка скала - Шублер

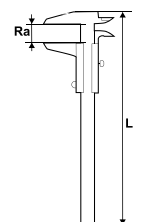

Art. № Art. №	Ra (mm)	Баркод Barcode
280301	0-150	
280300	0-200	





## CASTING LEVEL

- [BG] Нивелир алуминиев • [RO] Nivelă aluminiu turnat • [EL] Αλφάδι • [PT] Nivel aberto • [IT] Livella in alluminio
- [SR] Libela aluminijumska • [SL] Libela • [BH] Libela aluminijumska • [RU] Литоый Алюминиевый Уровень
- [MK] Алуминиумска либела

30  
YEARS  
WARRANTY

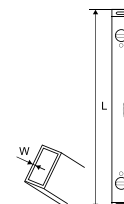

Art. № L Баркод  
Art. № (mm) Barcode

270117 500 

AL 0.5 mm/m MILLED

## ALUMINUM LEVEL

- [BG] Нивелир алуминиев с магнит • [RO] Nivelă aluminiu • [EL] Αλφάδι μαγνητικό • [PT] Nivel aberto
- [IT] Livella in alluminio • [SR] Libela aluminijumska • [SL] Libela • [BH] Libela aluminijumska
- [RU] Литоый Алюминиевый Уровень с магнетом • [MK] Алуминиумска либела с магнет

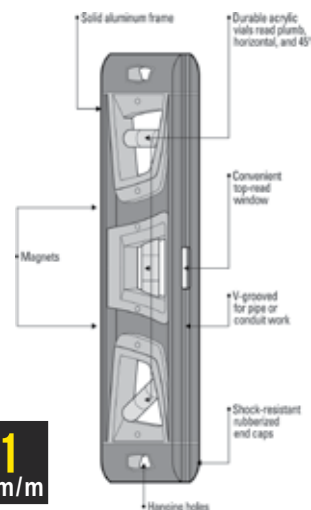

Art. № L Баркод  
Art. № (mm) Barcode

270116 250 

AL MAGNET x3 1 mm/m

## SPIRIT LEVEL

- [BG] Нивелир алуминиев с магнит • [RO] Nivelă aluminiu magnetica • [EL] Αλφάδι ψηφιακό • [PT] Nivel aberto • [IT] Livella in alluminio
- [SR] Libela aluminijumska magnetna • [SL] Libela • [BH] Libela aluminijumska • [RU] Алюминиевый Уровень с магнетом • [MK] Алуминиумска либела со магнет

Art. № L W Баркод  
Art. № (mm) (mm) Barcode

270307 400 1.5 

270308 600 1.5 

270309 800 1.5 

270310 1000 1.5 

270311 1200 1.5 

270312 1500 1.5 

270313 1800 1.5 



30  
YEARS  
WARRANTY

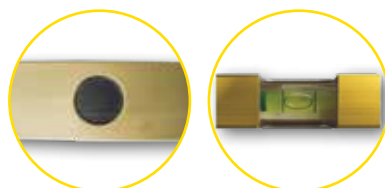

AL THICKNESS 1.5 mm MAGNET 0.5 mm/m

## SPIRIT LEVEL

- [BG] Нивелир алуминиев с магнит • [RO] Nivelă aluminiu magnetica • [EL] Αλφάδι φηφιακό • [PT] Nivel aberto • [IT] Livella in alluminio
- [SR] Libela aluminijumska magnetna • [SL] Libela • [BH] Libela aluminijumska • [RU] Алюминиевый Уровень • [MK] Магнетна либела

Art. № Art. №	L (mm)	W (mm)	Баркод Barcode
270107	400	1.5	
270108	500	1.5	
270109	600	1.5	
270110	800	1.5	
270111	1000	1.5	
270112	1200	1.5	
270113	1500	1.5	
270114	1800	1.5	

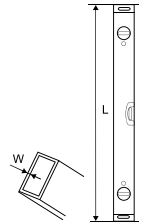

## ALUMINUM LEVEL

**NEW**

- [BG] Нивелир алуминиев • [RO] Nivelă aluminiu • [EL] Αλφάδι μαγνητικό • [PT] Nivel aberto • [IT] Livella in alluminio • [SR] Libela aluminijumska
- [SL] Libela • [BH] Libela aluminijumska • [RU] Литой Алюминиевый Уровень • [MK] Алуминиумска

арт. № art. №	L (mm)	W (mm)	Баркод Barcode
270801	400	1.5	
270802	600	1.5	
270803	800	1.5	
270804	1000	1.5	
270805	1200	1.5	
270806	1500	1.5	
270807	1800	1.5	



## TRIPOD

- [BG] Тринога • [RO] Tripod • [EL] τρίποδο • [PT] tripé • [IT] treppiedi • [SR] tronožac
- [SL] Stativa • [BH] tronožac • [RU] тренога • [MK] Тривоћац



арт. № art. №	H (mm)	Баркод Barcode
279907	1200	



# LASER DISTANCE METER TMP50

**NEW**

- [BG] Лазерен измервателен уред • [RO] Telemetru laser • [EL] Αποστασιόμετρο laser • [PT] Medidor de distâncias a laser
- [IT] Telemetro laser • [SR] Laserski daljinomer • [SL] Laserski merilnik • [BH] laserski mjerač • [RU] Лазерный Уровень • [MK] Метро ласерко

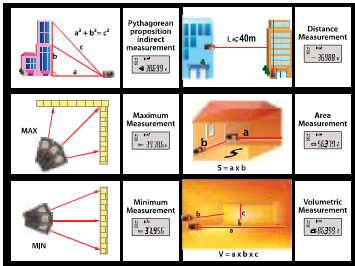

Art. № Art. №	Distance (m)	Баркод Barcode
261404	50	

**CE** **40m** **0.2 - 40m  
+/- 1.5mm**

# LASER LEVEL 3D

**NEW**

- [BG] Лазерен нивелир • [RO] Nivelă laser 3D • [EL] Επίπεδο λέιζερ • [PT] Nível de laser • [IT] Livello laser
- [SR] Nivo lasera • [SL] Raven laserja • [BH] Nivo lasera • [RU] Лазерный Уровень • [MK] Ласерски нив

## 4 TIMES BETTER VISIBILITY THAN RED LASER

Range: 30 m. (indoor); 15 m. (outdoor) 510-530 nm



арт. № art. №	Type	Баркод Barcode
279906	3 x 360 degrees	

**GREEN LASER** **LI-ION BATTERY** **CE**

# LASER LEVEL 1H1V

**NEW**

- [BG] Лазерен нивелир • [RO] Nivelă laser • [EL] Επίπεδο λέιζερ • [PT] Nível de laser • [IT] Livello laser
- [SR] Nivo lasera • [SL] Raven laserja • [BH] Nivo lasera • [RU] Лазерный Уровень • [MK] Ласерски ниво

## 4 TIMES BETTER VISIBILITY THAN RED LASER

Range: 30 m. (indoor); 15 m. (outdoor) 510-530 nm



арт. № art. №	Type	Баркод Barcode
279905	1 Horizontal, 1 Vertical	

**GREEN LASER** **2 AA BATTERY** **CE**

## SPIRIT LEVEL

- [BG] Нивелир алуминиев с подвижна либела • [RO] Nivelă aluminiu • [EL] Αλφάδι • [PT] Nivel aberto • [IT] Livella in alluminio
- [SR] Libela aluminijumska magnetna • [SL] Libela • [BH] Libela aluminijumska • [RU] Алюминиевый Уровень • [MK] Либела

арт. № art. №	L (mm)	W (mm)	Баркод Barcode
270301	600	2	
270302	800	2	
270303	1000	2	
270304	1200	2	
270305	1500	2	
270306	2000	2	

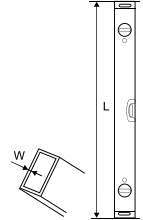

## SCREEDING LEVEL

- [BG] Мастер алуминиев • [RO] Dreptar aluminiu • [EL] Πήχης αλουμινίου απλός • [PT] Nivel especial • [IT] Livella senza bolla d'aria
- [SR] Ravnjača aluminijumska • [SL] Libela • [BH] Libela • [RU] Правило • [MK] Зидарска летва

Арт. № Art. №	L (mm)	W (mm)	Баркод Barcode
321722	1500	1	
321723	2000	1	
321724	2500	1	

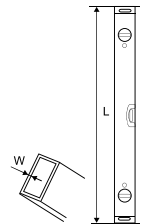

## SCREEDING LEVEL

- [BG] Мастер алуминиев скосен • [RO] Dreptar aluminiu • [EL] Πήχης αλουμινίου κοφτός • [PT] Nivel especial • [IT] Livella senza bolla d'aria
- [SR] Ravnjača aluminijumska kosa • [SL] Libela • [BH] Libela • [RU] Правило • [MK] Зидарска летва

арт. № art. №	L (mm)	W (mm)	Баркод Barcode
321701	1000	1.2	
321702	1500	1.2	
321703	2000	1.2	
321704	2500	1.2	
321705	3000	1.2	
321706	4000	1.2	

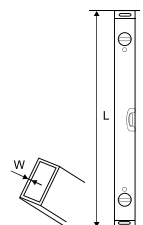



## SCREEDING LEVEL

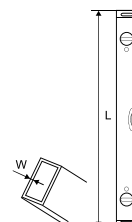

- [BG] Мастер алуминиев с либели • [RO] Dreptar aluminiu • [EL] Πήχης αλουμινίου κοφτός • [PT] Nível especial • [IT] Livella senza bolla d'aria
- [SR] Ravnjača aluminijumska sa libelom • [SL] Libela • [BH] Libela • [RU] Правило • [MK] Зидарска летва

арт. № art. №	L (mm)	W (mm)	Баркод Barcode
321708	1500	1.2	
321709	2000	1.2	
321710	2500	1.2	
321711	3000	1.2	



## SCREEDING LEVEL

- [BG] Мастер алуминиев с либели и рѣкохватки • [RO] Dreptar aluminiu • [EL] Πήχης αλουμινίου με αψάδι και λαβές • [PT] Nível especial
- [IT] Livella senza bolla d'aria • [SR] Ravnjača aluminijumska sa libelom • [SL] Libela • [BH] Libela • [RU] Правило • [MK] Зидарска летва

арт. № art. №	L (mm)	W (mm)	Баркод Barcode
321713	1000	1.2	
321714	1500	1.2	
321715	2000	1.2	
321716	2500	1.2	
321717	3000	1.2	

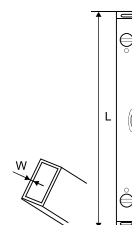

## SCREEDING LEVEL

- [BG] Мастер алуминиев "h" профил • [RO] Dreptar aluminiu • [EL] Πήχης αλουμινίου μηχανής • [PT] Nível especial • [IT] Livella senza bolla d'aria
- [SR] Ravnjača aluminijumska • [SL] Libela • [BH] Libela • [RU] Правило • [MK] Зидарска летва

арт. № art. №	L (mm)	W (mm)	Баркод Barcode
321719	1500	1.5	
321720	2000	1.5	
321721	2500	1.5	

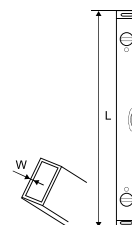
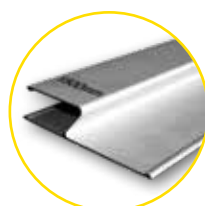

## FOLDING TRI-ANGLE SQUARE

- [BG] Сгъваем ъгъл • [RO] Echer pliabil • [EL] Γωνία αναδιπλούμενη • [PT] Esquadro • [IT] Squadra
- [SR] Vinkla trokraka • [SL] Kotomer • [BH] Vinklo • [RU] Складной Угольник • [MK] Винкла



Арт. № Art. №	L (mm)	Баркод Barcode
281206	1200	

## COMBINATION SQUARE

- [BG] Прав ъгъл комбиниран • [RO] Echer multifunctional • [EL] Γωνία μαραγκών με αλφάδι • [PT] Esquadro • [IT] Squadra
- [SR] Vinkl sa naslonom • [SL] Kotomer • [BH] Kombinovani lenjir • [RU] Комбинированный Прямой Угольник • [MK] Комбинирана винкла

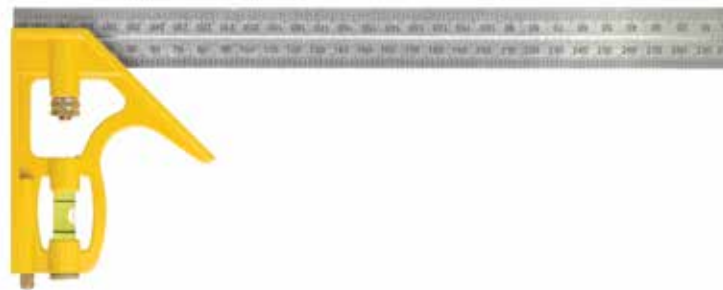

Арт. № Art. №	L (mm)	Баркод Barcode
281204	300	



## SPEED SQUARE

- [BG] Мултифункционален прав ъгъл • [RO] Echer profesional • [EL] Γωνία πολλαπλών χρήσεων • [PT] Esquadro • [IT] Squadra
- [SR] Uglomer sa naslonom • [SL] Kotomer • [BH] Kombinovani lenjir • [RU] Быстрый Квадрат • [MK] Аголник



Арт. № Art. №	L (mm)	Баркод Barcode
281210	178	



## BEVEL SQUARE

- [BG] Ъгломер алуминиев • [RO] Echer reglabil • [EL] Γωνία μαραγκών ρυθμιζόμενη • [PT] Esquadro • [IT] Squadra
- [SR] Uglomer pomični • [SL] Kotomer • [BH] Kombinovani lenjir • [RU] Угольник • [MK] Аголник



Арт. № Art. №	L (mm)	Баркод Barcode
------------------	-----------	-------------------

281205

300



## TRY SQUARE

- [BG] Прав ъгъл алуминиев • [RO] Echer • [EL] Γωνία μαραγκών • [PT] Esquadro • [IT] Squadra
- [SR] Vinkl sa naslonom • [SL] Kotomer • [BH] Kombinovani lenjir • [RU] Угольник • [MK] Винкла

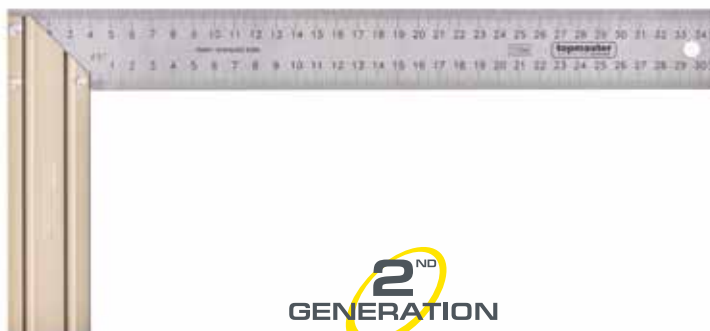

Арт. № Art. №	L (mm)	W (mm)	Баркод Barcode
------------------	-----------	-----------	-------------------

281200

300

145



281201

350

156



281202

400

175



# 6

## ЧУКОВЕ И ДЛЕТА HAMMERS & CHISELS





## ANTI-SHOCK CLAW HAMMER

- [BG] Чук тип "кози крак" антивибрационен • [RO] Ciocan antisoc • [EL] Σφυρί δίχαλο μαγνητικό αντικραδασμικό • [PT] Martelo antiochoque
- [IT] Martello antiurto • [SR] Čekić stolarski, sa magnetom, antivibracionom BI drškom • [SL] Tesarsko kladivo • [BH] Čekić
- [RU] Антивибрационный молоток - гвоздодёр • [MK] Чекан тип антивибрациона рачка

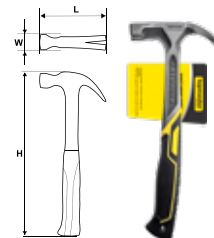

арт. № art. №	weight (g)	H (mm)	L (mm)	W (mm)	Баркод Barcode
249805	450	334	139	30	
249806	570	335	159	36	



## ONE - PIECE VELOCITY ROOFING HAMMER

- [BG] Чук кофражистки антивибрационен • [RO] Ciocan dulgher • [EL] Σφυρί δίχαλο μισό μαγνητικό • [PT] Martelo de unha reta
- [IT] Martello falegname • [SR] Čekić tesarski • [SL] Tesarsko kladivo • [BH] Čekić stolarski • [RU] АнтиВибрационный молоток кровельщика
- [MK] Чекан со антивибрациска рачка



Art. № Art. №	weight (g)	H (mm)	L (mm)	W (mm)	Баркод Barcode
249800	600	365	180	30	



## ONE - PIECE ROOFING HAMMER

- [BG] Чук кофражистки • [RO] Ciocan dulgher • [EL] Σφυρί δίχαλο μισό μαγνητικό • [PT] Martelo de unha reta
- [IT] Martello falegname • [SR] Čekić tesarski • [SL] Tesarsko kladivo • [BH] Čekić stolarski • [RU] АнтиВибрационный молоток кровельщика
- [MK] Чекан со антивибрациска рачка

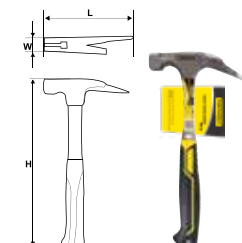

арт. № art. №	weight (g)	H (mm)	L (mm)	W (mm)	Баркод Barcode
249804	600	330	174	27	





# HIGH EFFICIENT HAMMER

- [BG] Чук високоинерционен • [RO] Ciocan dulgher • [EL] Σφυρί δίχαλο μαγνητικό • [PT] Marreta cabo fibra de vidro
- [IT] Mazza con manico in fibra • [SR] Čekić stolarski • [SL] Tesarsko kladivo • [BH] Čekić • [RU] Высоко инертный молоток • [MK] Чекан

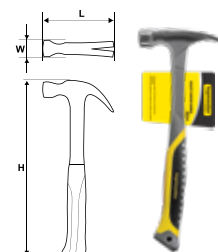

• **The ultra-thin and long shaft design reduces arm stress, it means a 450g hammer that strikes like a 800g**





Art. № Art. №	weight (g)	H (mm)	L (mm)	W (mm)	Баркод Barcode
244301	450	380	160	35	

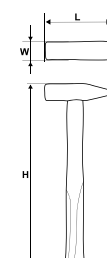

# MACHINIST HAMMER

- [BG] Чук с полиамид - фибростъкло дръжка • [RO] Ciocan lacatus • [EL] Σφυρί με πλαστική λαβή • [PT] Martelo cabo de fibra
- [IT] Martello falegname manico in fibra • [SR] Čekić sa PVC ergonomskom BI drškom • [SL] Ključavničarsko kladivo
- [BH] Čekić fiberglas drška • [RU] Молоток С ФиберГлаССовой Рукояткой • [MK] Чекан



арт. № art. №	weight (g)	H (mm)	L (mm)	W (mm)	Баркод Barcode
240125	100	270	94	20	
240126	200	280	96	21	
240127	300	300	105	22	
240128	400	314	113	26	
240129	500	315	118	27	
240130	600	316	120	29	
240131	800	350	130	32	
240132	1000	350	133	35	
240133	1500	380	144	40	
240134	2000	375	152	45	



## SLEDGE HAMMER

- [BG] Чук вария с полиамид - фибростъкло дръжка • [RO] Ciocan lacatus • [EL] Βαριά με πλαστική λαβή • [PT] Martelo cabo de fibra
- [IT] Martello falegname manico in fibra • [SR] Čekić sa PVC ergonomskom BI drškom • [SL] Kladivo • [BH] Čekić fiberglas drška
- [RU] Молоток С ФиберГлассовой Рукояткой • [MK] Чекан со Fiber Glass ергономска рачка



арт. № art. №	weight (g)	H (mm)	L (mm)	W (mm)	Баркод Barcode
240135	3000	885	158	57	
240136	5000	900	185	69	
240137	8000	910	205	80	

2<sup>ND</sup>  
GENERATION

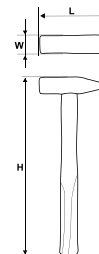

C45

DIN  
1042

## SLEDGE HAMMER

- [BG] Чук вария с полиамид - фибростъкло дръжка • [RO] Ciocan lacatus • [EL] Βαριά με πλαστική λαβή • [PT] Martelo cabo de fibra
- [IT] Martello falegname manico in fibra • [SR] Čekić macola sa PVC ergonomskom BI drškom • [SL] Kladivo • [BH] Čekić fiberglas drška
- [RU] Молоток С ФиберГлассовой Рукояткой • [MK] Чекан со Fiber Glass рачка



арт. № art. №	weight (g)	H (mm)	L (mm)	W (mm)	Баркод Barcode
240122	5000	885	158	69	
240123	8000	910	180	79	

2<sup>ND</sup>  
GENERATION

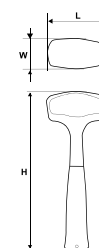

C45

## ROOFING HAMMER

- [BG] чук кофражен с полиамид - фибростъкло дръжка • [RO] Ciocan dulgher cu coada fibra
- [EL] Σφυρί δίχαλο μισό μαγνητικό με πλαστική λαβή • [PT] Martelo de unha reta
- [IT] Martello falegname con manico in fibra
- [SR] Čekić tesarski sa magnetom, ergonomskom drškom
- [SL] Krovno kladivo • [BH] Čekić stolarski
- [RU] Молоток С ФиберГлассовой Рукояткой
- [MK] Чекан со Fiber Glass рачка



арт. № art. №	weight (g)	H (mm)	L (mm)	W (mm)	Баркод Barcode
249807	600	330	165	27	

2<sup>ND</sup>  
GENERATION

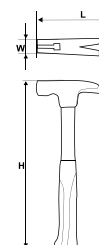

C45

MAGNET

## MACHINIST HAMMER

- [BG] Чук с метална дръжка • [RO] Ciocan maner metal + fibra • [EL] Σφυρί με εργονομική λαβή • [PT] Martelo cabo tubular
- [IT] Martello manico metallico + fibra fibra • [SR] Čekić sa metalnom ergonomskom BI drškom • [SL] Kladivo • [BH] Čekić
- [RU] Молоток С Трубчатой Металлической Рукояткой • [MK] Чекан

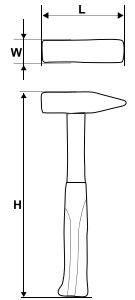

арт. № art. №	weight (g)	H (mm)	L (mm)	W (mm)	Баркод Barcode
240119	300	300	104	24	
240120	500	320	118	29	



C45

## STONING HAMMER

- [BG] Чук за камък с метална дръжка • [RO] Ciocan patrat cu coada metal • [EL] Βαριοπούλα με εργονομική λαβή • [PT] Marreta cabo tubular
- [IT] Martello quadrato con manico metallico • [SR] Macola sa metalnom ergonomskom BI drškom • [SL] Kladivo • [BH] Čekić macola
- [RU] Молоток Для Камня С Металлической Рукояткой • [MK] Чекан

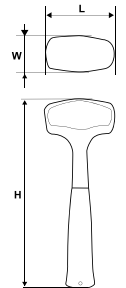

арт. № art. №	weight (g)	H (mm)	L (mm)	W (mm)	Баркод Barcode
240509	1000	282	95	42	



C45

## CLAW HAMMER

- [BG] Чук тип "кози крак" с метална дръжка • [RO] Ciocan tamplar cu maner metalic • [EL] Σφυρί δίχαλο με εργονομική λαβή
- [PT] Martelo de orelhas • [IT] Martello carpentiere a manico metallico • [SR] Čekić stolarski metalni sa ergonomskom BI drškom
- [SL] Zidarsko kladivo • [BH] Čekić • [RU] Молоток - гвоздодёр с металлической рукояткой • [MK] Чекан

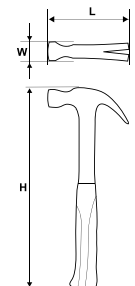

арт. № art. №	weight (g)	H (mm)	L (mm)	W (mm)	Баркод Barcode
249801	450	320	130	30	



C45



## ROOFING HAMMER

- [BG] Чук кофражен с метална дръжка • [RO] Ciocan dulgher cu coada metalica • [EL] Σφυρί δίχαλο μισό μαγνητικό με εργονομική λαβή
- [PT] Martelo tubular de unha reta • [IT] Martello falegname con manico metallico • [SR] Tesarski čekić sa magnetom, ergonomskom BI drškom
- [SL] Krovno kladivo • [BH] Čekić stolarski • [RU] Молоток Кровельщика С Металлической Рукояткой • [MK] Чекан за столари

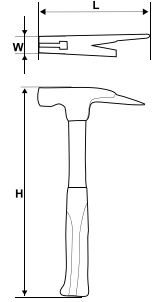

арт. № art. №	weight (g)	H (mm)	L (mm)	W (mm)	Баркод Barcode
------------------	---------------	-----------	-----------	-----------	-------------------

249802	600	320	165	28	
--------	-----	-----	-----	----	--



## MASON'S HAMMER

- [BG] Чук зидарски с метална дръжка • [RO] Ciocan zidar cu coada metalica • [EL] Σφυρί τούβλου με εργονομική λαβή
- [PT] Martelo de pedreiro tubular • [IT] Martello muratore con manico metallico • [SR] Čekić zidarski sa ergonomskom BI drškom
- [SL] Zidarsko kladivo • [BH] Čekić • [RU] Молоток MASON с трубчатой мет. ручкой • [MK] Чекан

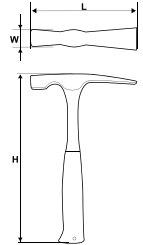

арт. № art. №	weight (g)	H (mm)	L (mm)	W (mm)	Баркод Barcode
------------------	---------------	-----------	-----------	-----------	-------------------

249803	600	280	200	26	
--------	-----	-----	-----	----	--



## DEAD BLOW MALLET

- [BG] Чук безоткатен с PU накрайници • [RO] Ciocan plastic cu maner lemn • [EL] Ματσόλα με ξύλινη λαβή
- [PT] Martelo sem recuo • [IT] Martello senza contraccollo • [SR] Čekić PVC • [SL] Gumijasto kladivo • [BH] Čekić
- [RU] Безоткатный Молоток • [MK] Чекан

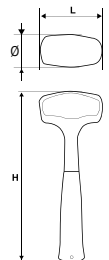

арт. № art. №	weight (g)	H (mm)	L (mm)	Ø (mm)	Баркод Barcode
------------------	---------------	-----------	-----------	-----------	-------------------

240138	265	318	94	30	
--------	-----	-----	----	----	--

240139	430	350	100	40	
--------	-----	-----	-----	----	--



# MACHINIST HAMMER

- [BG] Чук с дървена дръжка • [RO] Ciocan lacatus cu maner lemn • [EL] Σφυρί με ξύλινη λαβή • [PT] Martelo cabo de madeira
- [IT] Martello fabbro a manico in legno • [SR] Čekić sa drvenom drškom • [SL] Kladivo • [BH] Čekić • [RU] Молоток
- [MK] Чекан со дрвена рачка



STEEL PROTECTOR

RIVET

ROUND WEDGE

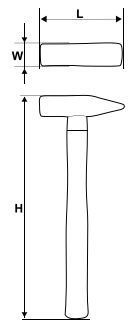

art. № art. №	weight (g)	H (mm)	L (mm)	W (mm)	Баркод Barcode
240101	100	260	80	15	
240102	200	280	93	20	
240103	300	300	103	21	
240104	400	310	112	25	
240105	500	320	118	26	
240107	800	355	129	33	
240108	1000	360	132	35	
240109	1500	380	143	40	
240110	2000	400	153	45	



# STONING HAMMER



- [BG] Чук с дървена дръжка • [RO] Ciocan lacatus cu maner lemn • [EL] Σφυρί με ξύλινη λαβή • [PT] Martelo cabo de madeira • [IT] Martello fabbro a manico in legno • [SR] Čekić sa drvenom drškom • [SL] Kladivo • [BH] Čekić • [RU] Молоток • [MK] Чекан со дрвена рачка



art. № art. №	weight (g)	H (mm)	L (mm)	W (mm)	Баркод Barcode
240141	100	260	80	15	
240142	200	280	93	20	
240143	300	300	103	21	
240144	400	310	112	25	
240145	500	320	118	26	
240146	800	355	129	33	
240147	1000	360	132	35	
240148	1500	380	143	40	
240149	1800	400	153	45	



# STONING HAMMER

- [BG] Чук за камък • [RO] Ciocan patrat cu maner lemn • [EL] Βαριοπούλα με ξύλινη λαβή • [PT] Marreta cabo madeira • [IT] Martello quadrato
- [SR] Macola sa drvenom drškom • [SL] Kladivo • [BH] Čekić macola • [RU] Молоток Для Камня • [MK] Зидарски чекан



STEEL  
PROTECTOR

RIVET

ROUND  
WEDGE

арт. № art. №	weight (g)	H (mm)	L (mm)	W (mm)	Баркод Barcode
240502	1000	260	95	40	
240503	1500	280	110	45	
240504	2000	300	120	50	



C45

ASH  
WOOD

# MACHINIST HAMMER

- [BG] Чук с полиамид - фибростъкло дръжка • [RO] Ciocan lacatus • [EL] Σφυρί με πλαστική λαβή • [PT] Martelo cabo fibra de vidro
- [IT] Martello falegname - manico in fibra • [SR] Čekić sa fiber drškom • [SL] Ključavničarsko kladivo • [BH] Čekić fiberglas drška
- [RU] Молоток С ФиберГлассовой Рукояткой • [MK] Чекан

арт. № art. №	m (g)	H (mm)	L (mm)	W (mm)	Баркод Barcode
240111	100	260	80	15	
240112	200	280	93	20	
240113	300	300	103	21	
240114	500	320	118	26	
240116	1000	360	132	35	
240117	1500	380	143	40	
240118	2000	400	153	45	



C45

## RUBBER MALLET FIBERGLASS

- [BG] Чук гумен с фибростъкло дръжка • [RO] Ciocan cauciuc cu coada fibra • [EL] Ματσόλα μαύρη με εργονομική λαβή
- [PT] Maço cabo fibra de vidro • [IT] Martello gomma con manico in fibra • [SR] Čekić gumeni sa fiber drškom • [SL] Gumijasto kladivo
- [BH] Čekić fibreglas drška • [RU] Резиновый Молоток С ФиберГлассовой Рукояткой • [MK] Пластичен чекан



арт. № art. №	m (g)	H (mm)	L (mm)	W (mm)	Баркод Barcode
240903	340	333	87.5	54	
240904	450	345	96	59	
240905	680	380	110	65	

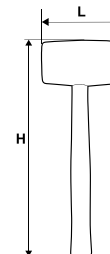

## RUBBER MALLET FIBERGLASS

- [BG] Чук гумен с фибростъкло дръжка • [RO] Ciocan cauciuc cu coada fibra • [EL] Ματσόλα μαύρη με εργονομική λαβή
- [PT] Maço cabo fibra de vidro • [IT] Martello gomma con manico in fibra • [SR] Čekić gumeni sa fiber drškom • [SL] Gumijasto kladivo
- [BH] Čekić fibreglas drška • [RU] Резиновый Молоток С ФиберГлассовой Рукояткой • [MK] Пластичен чекан



арт. № art. №	m (g)	H (mm)	L (mm)	W (mm)	Баркод Barcode
240908	450	345	96	59	

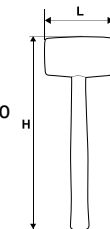

## RUBBER MALLET FIBERGLASS

- [BG] Чук гумен с фибростъкло дръжка • [RO] Ciocan cauciuc cu coada fibra • [EL] Ματσόλα λευκή με εργονομική λαβή
- [PT] Maço cabo fibra de vidro • [IT] Martello gomma con manico in fibra • [SR] Čekić gumeni sa fiber drškom • [SL] Gumijasto kladivo
- [BH] Čekić fibreglas drška • [RU] Резиновый Молоток С ФиберГлассовой Рукояткой • [MK] Пластичен чекан



арт. № art. №	m (g)	H (mm)	L (mm)	W (mm)	Баркод Barcode
240906	340	333	87.5	54	

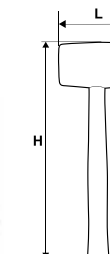



# WOOD CHISEL

- [BG] Длето • [RO] Dalta lemni • [EL] Σκαρπέλο • [PT] Formão para madeira • [IT] Scalpello legno • [SR] Dleto za drvo sa BI drškom
- [SL] Dleto • [BH] Dlijeto • [RU] Зубило По Дереву • [MK] Длето

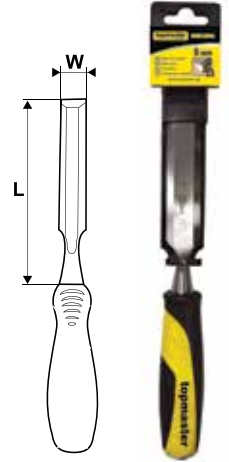

арт. № art. №	W (mm)	L (mm)	Баркод Barcode
350121	6	140	
350122	8	140	
350123	10	140	
350124	12	140	
350125	13	140	
350126	14	140	
350127	16	140	
350128	18	140	
350129	19	140	

350130	20	140	
350131	22	140	
350132	24	140	
350133	25	140	
350134	26	140	
350135	28	140	
350136	30	140	
350137	32	140	
350138	38	140	



Mn  
**65**

# WOOD CHISEL SET

- [BG] Комплект длета • [RO] Dalti pentru lemni • [EL] Σκαρπέλα σετ • [PT] Formão de madeira • [IT] Scalpelli per legno • [SR] Set dleta za drvo
- [SL] Komplet sekačev 3 Pcs • [BH] Dlijeto špicasto • [RU] Комплект Зубил • [MK] Гарнитура со длета

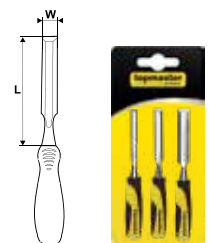

арт. № art. №	W (mm)	L (mm)	Баркод Barcode
350139	12, 18, 24	140	

Mn  
**65**

**X3**

## BRICK BOLSTERS

- [BG] Длето лопатка с протектор • [RO] Dalta lata cu protectie • [EL] Καλέμι πλατύ με λαβή • [PT] Escopro largo com proteção
- [IT] Scalpello largo con paramano • [SR] Sekač za ciglu • [SL] Dleto • [BH] Dlijeto • [RU] Зубило Лопатка С Протектором
- [MK] Секач

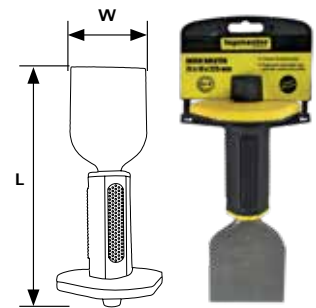

арт. № art. №	W (mm)	Ø (mm)	L (mm)	Баркод Barcode
329921	75	19	225	



## POINTED CHISEL

- [BG] Длето остро с протектор • [RO] Spit cu protectie • [EL] Βελόνη με λαβή • [PT] Ponteiro com proteção • [IT] Punzone con paramano
- [SR] Špic ručni za beton • [SL] Dleto • [BH] Dlijeto pljosnato • [RU] Зубило Пиковое • [MK] Секач

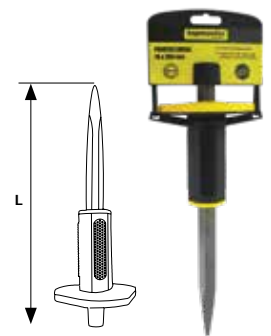

арт. № art. №	Ø (mm)	L (mm)	Баркод Barcode
329919	18	300	



## FLAT CHISEL

- [BG] Длето - секач с протектор • [RO] Dalta cu protectie • [EL] Καλέμι με λαβή • [PT] Escopro com proteção • [IT] Scalpello con paramano
- [SR] Sekač ručni za beton • [SL] Dleto • [BH] Čekić zidarski • [RU] Зубило Плоское
- [MK] Секач

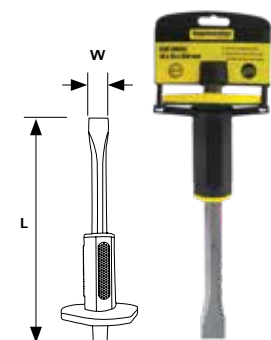

арт. № art. №	W (mm)	Ø (mm)	L (mm)	Баркод Barcode
329920	26	18	300	







7

РЕЖЕЩИ  
CUTTING TOOLS





## HAND SAW FOR WOOD

- [BG] Трион за дърво • [RO] Fierastrau de mana teflonat • [EL] Σεγάτσα με τεφλόν • [PT] Serra de mão
- [IT] Sega a mano in teflone • [SR] Testera za drvo teflon, BI drška • [SL] Žaga lisičji rep ojačana • [BH] Pila bonsek • [RU] Пила • [MK] Пила за дрво

2<sup>ND</sup>  
GENERATION

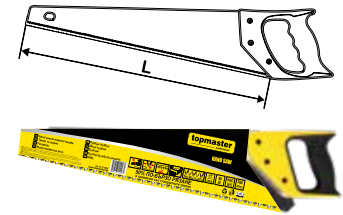

Art. № Art. №	L (mm)	TPI	Баркод Barcode
371525	450	7	



## HAND SAW FOR WOOD

- [BG] Трион за дърво • [RO] Fierastrau de mana • [EL] Σεγάτσα • [PT] Serra de mão
- [IT] Sega a mano in teflone • [SR] Testera za drvo, BI drška • [SL] Žaga lisičji rep • [BH] Pila bonsek • [RU] Пила • [MK] Пила за дрво

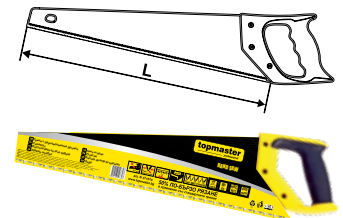

Art. № Art. №	L (mm)	TPI	Баркод Barcode
371510	400	7	
371511	450	7	
371512	500	7	



## COMPASS SAW

- [BG] Трион кръгов • [RO] Fierastrau pentru lemn • [EL] Σεγάτσα στενή • [PT] Serra de mão para cortes redondos • [IT] Sega per legno
- [SR] Testera za drvo špic, sa BI drškom • [SL] Žaga lisičji rep ozka • [BH] Pila • [RU] Выкружная Пила • [MK] Пила

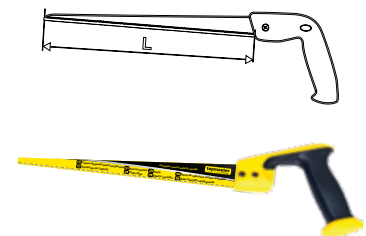

Art. № Art. №	L (mm)	TPI	Баркод Barcode
371515	300	7	



## BACK SAW

- [BG] Трион пасвател • [RO] Fierastrau taiere la unghi • [EL] Φαλτσοπρίοно • [PT] Serrote de mão bi-material
- [IT] Ferestrau trasare unghi-drept • [SR] Testera za ger sa BI drškom • [SL] Lisičji rep • [BH] Ekstraktor za vijke • [RU] Ножовка
- [MK] Пила за жлебови

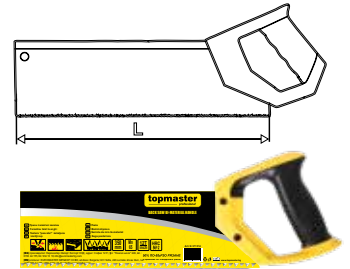

Art. № Art. №	L (mm)	TPI	Баркод Barcode
371514	350	12	



## MITRE BOX & BACK SAW SET

- [BG] Трион пасвател комплект • [RO] Set fierastrau taiere la unghi • [EL] Φαλτσοπρίοно με φαλτσοκούτι • [PT] Jogo de esquadrias
- [IT] Ferestrau trasare la unghi • [SR] Ručni ger sa testerom sa BI drškom • [SL] Predalčnik PVC z žago • [BH] Ekstraktor za vijke
- [RU] Комплект Ножовка + Стусло • [MK] Гарнитула пила за жлебови со аголен шаблон

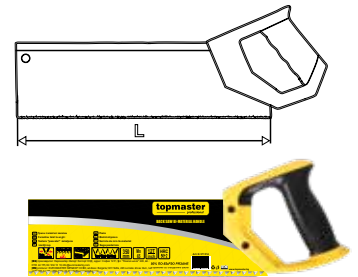

Art. № Art. №	L (mm)	TPI	Баркод Barcode
371722	300	12	



## VINEER SAW

- [BG] Трион за фурнир • [RO] Fierastrau maner bi-material • [EL] Σεγάτσα διπλής κοπής • [PT] Serrote de mão bi-material
- [IT] Ferestrau trasare unghi-semirotund • [SR] Testera za furnir sa BI drškom • [SL] Ročna žaga • [BH] Пила • [RU] Пила • [MK] Пила за фурнир

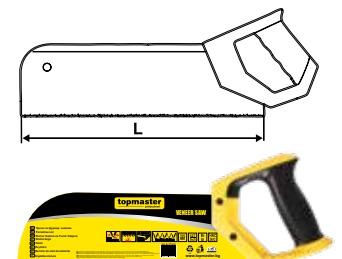

Art. № Art. №	L (mm)	TPI	Баркод Barcode
371513	325	12	



## LIGHT CONCRETE SAW

- [BG] Трион за газобетон • [RO] Fierastrau BCA reglabil • [EL] Πριόνι ελαφρομπετού • [PT] Serrote para ytong • [IT] Sega regolabile
- [SR] Testera za siporeks sklopiva • [SL] Žaga za celični beton • [BH] Pila • [RU] Пила Для Газобетона • [MK] Пила за лесен бетон

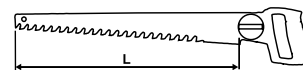

Art. № L Баркод  
Art. № (mm) Barcode

379906 500 



## LIGHT CONCRETE SAW

- [BG] Трион за газобетон • [RO] Fierastrau BCA • [EL] Πριόνι ελαφρομπετου • [PT] Serrote para ytong • [IT] Sega regolabile
- [SR] Testera za siporeks • [SL] Žaga za celični beton • [BH] Pila • [RU] Пила Для Газобетона • [MK] Пила за лесен бетон

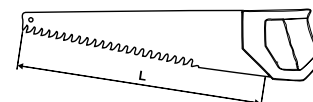

Art. № L Баркод  
Art. № (mm) Barcode

379902 700 



## HAND SAW

- [BG] Трион • [RO] Fierastrau rigips • [EL] Fierastrau rigips • [PT] Serra de mão bi-material • [IT] Sega cartongesso
- [SR] Testera za drvo/gips kaljeni vrh, BI drška • [SL] Ročna žaga • [BH] Pila • [RU] Пила • [MK] Пила

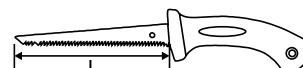

Art. № L Баркод  
Art. № (mm) Barcode

371517 150 



## HAND SAW

- [BG] Трион • [RO] Fierastrau rigips • [EL] Πριόνι γυψοσανίδας • [PT] Serra de mão bi-material • [IT] Sega cartongesso
- [SR] Testera za drvo/gips dvostrana, kaljeni vrh, BI drška • [SL] Ročna žaga • [BH] Pila • [RU] Пила • [MK] Пила

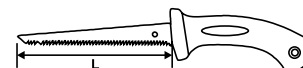

Art. № L Баркод  
Art. № (mm) Barcode

372301 150 



## HAND SAW

- [BG] Трион с калъф • [RO] Fierastrau rigips cu teaca • [EL] Πριόνι γυψοσανίδας με θήκη • [PT] Serra de mão bi-material
- [IT] Sega cartongesso con fodero • [SR] Testera za drvo/gips, kaljeni vrh, BI drška sa futrolom • [SL] Ročna žaga • [BH] Pila sa duplom ručkom
- [RU] Пила С Футляром • [MK] Пила

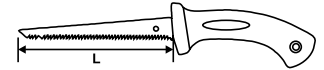

Art. № L Баркод  
Art. № (mm) Barcode

371518 150 



## HACKSAW FRAME 3D

- [BG] Ножовка за метал 3D • [RO] Bomfaier cu protectie • [EL] Σκελετά σιδηροπριόνου 3D • [PT] Serra corte ferro com proteção
- [IT] Seghetto a mano con protezione 3D • [SR] Bonsek ram 3D • [SL] Žaga za kovino lok • [BH] Nožići za skalpel 3d
- [RU] Ножовка Для Металла 3D • [MK] Бонсек 3D

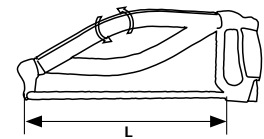

Art. № L Баркод  
Art. № (mm) Barcode

371114 300 

AL

## HACKSAW FRAME

- [BG] Ножовка за метал • [RO] Bomfaier • [EL] Σκελετά σιδηροπριόνου • [PT] Serra corte ferro com proteção
- [IT] Seghetto a mano con protezione • [SR] Bonsek ram • [SL] Žaga lokarica • [BH] Nožići za skalpel
- [RU] Ножовка Для Металла • [MK] Бонсек

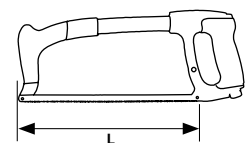

Art. № L Баркод  
Art. № (mm) Barcode

371111 300 



## VDE KNIFE

- [BG] Нож за оголване с предпазител • [RO] Cutit izolat pentru electricieni • [EL] Γδάρτης μαχαιρι καλωδιων με μονωση
- [PT] X-acto • [IT] Taglierino metallico multiuso • [SR] Nož za skidanje izolacije, izolovan • [SL] Skalpel • [BH] Skalpel
- [RU] Нож Универсальный • [MK] Скалпел VDE

- За премахване на външна изолация на СВТ кабел с предпазител



Art. № Art. №	L (mm)	Баркод Barcode
370109	190	

SK4  
STEEL

CU

AL



## UTILITY KNIFE

- [BG] Нож макетен • [RO] Cutter multifunctional • [EL] Φαλτσέτα πλαστικη • [PT] X-acto
- [IT] Taglierino metallico multiuso • [SR] Skalpel metalni • [SL] Večnamenski olfa nož
- [BH] Skalpel • [RU] Нож Универсальный • [MK] Скалпел

Art. № Art. №	W (m)	L (m)	Баркод Barcode
370102	9	130	

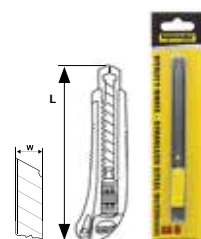
STAINLESS  
STEELSK5  
STEEL

## UTILITY KNIFE

- [BG] Нож макетен • [RO] Cutter multifunctional • [EL] Φαλτσέτα πλαστικη • [PT] X-acto
- [IT] Taglierino metallico multiuso • [SR] Skalpel sa gumenom drškom • [SL] Večnamenski olfa nož
- [BH] Skalpel • [RU] Нож Универсальный • [MK] Скалпел

Art. № Art. №	W (mm)	L (mm)	Баркод Barcode
370118	9	135	

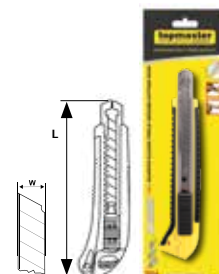
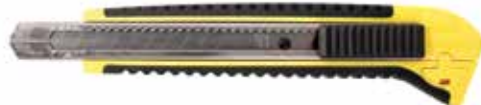
1  
2  
3SK4  
STEEL

## UTILITY KNIFE

- [BG] Нож макетен • [RO] Cutter multifunctional • [EL] Φαλτσέτα πλαστικη • [PT] X-acto
- [IT] Taglierino metallico multiuso • [SR] Skalpel metalni • [SL] Večnamenski olfa nož
- [BH] Skalpel • [RU] Нож Универсальный • [MK] Скалпел



Art. № Art. №	W (mm)	L (m)	Баркод Barcode
370111	9	135	

MEGA SHARP  
BLACK  
BLADE  
SK21  
2  
3SK2  
STEEL

## UTILITY KNIFE

- [BG] Нож макетен • [RO] Cutter multifunctional • [EL] Φαλτσέτα πλαστική • [PT] X-acto
- [IT] Taglierino metallico multiuso • [SR] Skalpel metalni • [SL] Večnamenski olfa nož • [BH] Skalpel
- [RU] Нож Универсальный • [МК] Скалпел



Art. № Art. №	W (mm)	L (m)	Баркод Barcode
370110	18	160	



## UTILITY KNIFE

- [BG] Нож макетен • [RO] Cutter multifunctional • [EL] Φαλτσέτα πλαστική • [PT] X-acto
- [IT] Taglierino metallico multiuso • [SR] Skalpel sa gumenom drškom • [SL] Večnamenski olfa nož • [BH] Skalpel
- [RU] Нож Универсальный • [МК] Скалпел



Art. № Art. №	W (m)	L (m)	Баркод Barcode
370124	25	200	

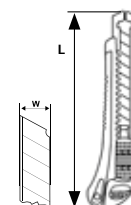

## UTILITY KNIFE

- [BG] Нож макетен • [RO] Cutter multifunctional • [EL] Φαλτσέτα πλαστική • [PT] X-acto • [IT] Taglierino metallico multiuso • [SR] Skalpel sa gumenom drškom • [SL] Večnamenski olfa nož • [BH] Skalpel • [RU] Нож Универсальный • [МК] Скалпел



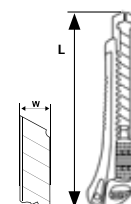

Art. № Art. №	W (mm)	L (mm)	Баркод Barcode
370303	25	200	

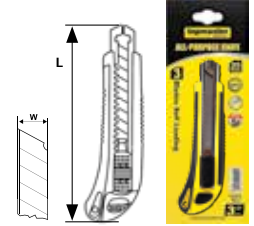

# UTILITY KNIFE

- [BG] Нож макетен • [RO] Cutter multifunctional • [EL] Φαλτσέτα πλαστική • [PT] X-acto
- [IT] Taglierino metallico multiuso • [SR] Skalpel sa gumenom drškom • [SL] Večnamenski olfa nož • [BH] Skalpel
- [RU] Нож Универсальный • [MK] Скалпел





Art. № Art. №	W (mm)	L (mm)	Баркод Barcode
370108	18	170	 318001231107511

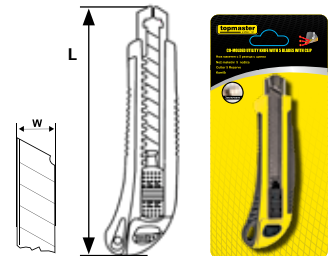

# UTILITY KNIFE

- [BG] Нож макетен • [RO] Cutter multifunctional • [EL] Φαλτσέτα πλαστική • [PT] X-acto
- [IT] Taglierino metallico multiuso • [SR] Skalpel sa gumenom drškom • [SL] Olfa nož z zaponko • [BH] Skalpel
- [RU] Нож Универсальный • [MK] Скалпел





Art. № Art. №	W (mm)	L (mm)	Баркод Barcode
370117	18	170	 318001231107214

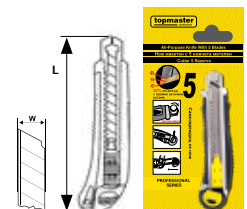

# UTILITY KNIFE

- [BG] Нож макетен • [RO] Cutter multifunctional • [EL] Φαλτσέτα μεταλλική • [PT] X-acto
- [IT] Taglierino metallico multiuso • [SR] Skalpel sa gumenom drškom • [SL] Večnamenski olfa nož
- [BH] Skalpel • [RU] Нож Универсальный • [MK] Скалпел



Art. № Art. №	W (mm)	L (mm)	Баркод Barcode
370116	18	170	 318001231107191



## UTILITY KNIFE

- [BG] Нож макетен • [RO] Cutter multifunctional • [EL] Φαλτσέτα μεταλλική • [PT] X-acto
- [IT] Taglierino metallico multiuso • [SR] Skalpel sa gumenom drškom • [SL] Večnamenski olfa nož • [BH] Skalpel
- [RU] Нож Универсальный • [MK] Скалпел



Art. № Art. №	W (mm)	L (mm)	Баркод Barcode
370101	18	180	



## DUAL BLADE UTILITY KNIFE

- [BG] Двоен нож трапец • [RO] Cutter multifunctional • [EL] Κόφτης μοκέτας με κοίλη λάμα • [PT] X-acto
- [IT] Taglierino metallico multiuso • [SR] Skalpel metalni • [SL] Večnamenski olfa nož • [BH] Skalpel
- [RU] Двойной трапец нож • [MK] Скалпел

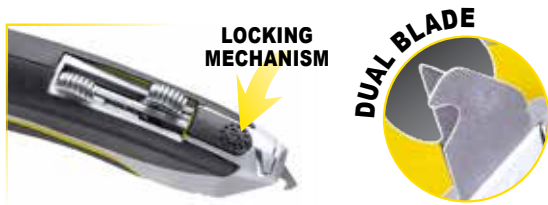

Art. № Art. №	W (mm)	L (mm)	Баркод Barcode
370131	30	180	



## UTILITY KNIFE

- [BG] Нож макетен трапец • [RO] Cutter multifunctional • [EL] Κόφτης μοκέτας • [PT] X-acto
- [IT] Taglierino metallico multiuso • [SR] Skalpel metalni • [SL] Večnamenski olfa nož • [BH] Skalpel
- [RU] Нож Трапец • [MK] Скалпел



Art. № Art. №	L (mm)	Баркод Barcode
370151	170	





## UTILITY KNIFE

- [BG] Нож трапец кука • [RO] Cutter multifunctional • [EL] Κόφτης μοκέτας με κοίλη λάμα • [PT] X-acto
- [IT] Taglierino metallico multiuso • [SR] Skalpel metalni • [SL] Večnamenski olfa nož • [BH] Skalpel
- [RU] Нож Трапец Крюк • [MK] Скалпел

2<sup>ND</sup>  
GENERATION



Art. №	L	Баркод
Art. №	(m)	Barcode
370152	170	



## UTILITY KNIFE

- [BG] Нож макетен • [RO] Cutter multifunctional • [EL] Κόφτης μοκέτας μεταλλικός • [PT] X-acto
- [IT] Taglierino metallico multiuso • [SR] Skalpel sklopivi • [SL] Večnamenski olfa nož • [BH] Skalpel
- [RU] Нож Универсальный • [MK] Скалпел



Art. №	W	L	L'	Баркод
Art. №	(mm)	(mm)	(mm)	Barcode
370130	18	158	106	



## SPARE BLADES

- [BG] Резци за макетен нож • [RO] Set 10 lame cutter • [EL] Λάμες φαλτσέτας μαύρες
- [PT] Set Lâminas • [IT] Lame di ricambio cutter • [SR] Nož za skalpel • [SL] Lomljiva rezila
- [BH] Nožići za skalpel • [RU] Лезвия Для Ножа Универсального • [MK] Резервни ножеви

MEGA SHARP  
BLACK  
BLADE  
SK2

Art. №	L	W	L	Баркод
Art. №	(m)	(m)	(m)	Barcode
370302	100	18	0.6	
370125	125	25	0,7	



## SPARE BLADES

- [BG] Резци за макетен нож • [RO] Set 10 lame cutter • [EL] Λάμες φαλτσέτας • [PT] Set Lâminas
- [IT] Lame di ricambio cutter • [SR] Nož za skalpel • [SL] Lomljiva rezila • [BH] Nožići za skalpel
- [RU] Лезвия Для Ножа Универсального • [MK] Резервни ножеви

2<sup>ND</sup>  
GENERATION

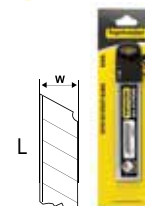
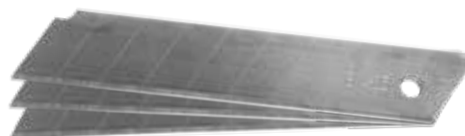

Art. № Art. №	W (mm)	L (mm)	дебелина thickness	Баркод Barcode
370121	9	80	0.4 mm	
370122	18	100	0.5 mm	



## SPARE BLADES

- [BG] Резци за макетен нож • [RO] Set 10 lame cutter • [EL] Λάμες κόφτη μοκέτας κοίλες • [PT] Set Lâminas
- [IT] Lame di ricambio cutter • [SR] Nož za skalpel • [SL] Lomljiva rezila • [BH] Nožići za skalpel
- [RU] Лезвия Для Ножа Универсального • [MK] Резервни ножеви

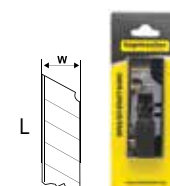

Art. № Art. №	L (m)	L (m)	Баркод Barcode
370301	19	60	



## SPARE BLADES

- [BG] Резци за макетен нож • [RO] Set 10 lame cutter • [EL] Λάμες για ξύστρα • [PT] Set Lâminas
- [IT] Lame di ricambio cutter • [SR] Nož za skalpel • [SL] Lomljiva rezila • [BH] Nožići za skalpel
- [RU] Лезвия Для Ножа Универсального • [MK] Резервни ножеви

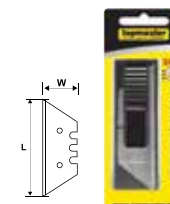

Art. № Art. №	W (mm)	L (mm)	Баркод Barcode
370123	19	60	



## PVC PIPE CUTTER

- [BG] Ножица за PP/PVC тръби • [RO] Foarfeca taiat tevi cu lama tratata la cald • [EL] Κόφτης σωλήνα pvc-pp • [PT] Alicates corta tubos
- [IT] Cesovia tagliatubi con lama trattata termicamente • [SR] Makaze za sečenje PVC cevi • [SL] Rezalec cevi • [BH] Makaze za pvc cijevi
- [RU] Труборез Для Пластика С Закаленным Лезвием • [MK] Ножици за сечење PVC цевки



Art. № Max Ø  
Art. № (mm) Баркод  
Barcode

371001

42

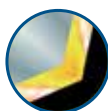

Sk4 blade with HRC 57±1°  
special blade-edge design,  
saving 30% of the power

PVC

PP

SK4  
STEEL

## GROUT SAW

- [BG] Стъргало за fugи • [RO] Racleta pentru rosturi placi ceramice • [EL] Ξύστρα αρμών • [PT] Raspador de tinta com lâmina
- [IT] Raschiatore • [SR] Grebač • [SL] Strgalo • [BH] Čistač fugе • [RU] Шабер • [MK] Чистач за fugи



Art. № Баркод  
Art. № Barcode

379601



CARBIDE

## GROUT SAW

- [BG] Стъргало с резци комплект • [RO] Razuitoar cu 10 lame • [EL] Ξύστρα με 10 λάμες • [PT] Raspador de tinta com lâmina
- [IT] Raschiatore a 10 lamelle • [SR] Grebač sa 10 rezervnih noževa • [SL] Strgalo • [BH] Strugač • [RU] Шабер + лезвия
- [MK] Стругач

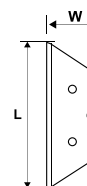

Art. № W L Баркод  
Art. № (mm) (mm) Barcode

379904

19

60



X10

## COMPACT AVIATION SNIPS RIGHT

- [BG] Ножица за ламарина компактна дясна • [RO] Foarfeca tabla pe dreapta • [EL] Ψαλίδι λαμαρίνας μινι δεξι
- [PT] Tesoura compacta corte chapa direita • [IT] Cesovia lamiera per taglio a destra "R" • [SR] Makaze za lim 180mm, zglobne, desne
- [SL] Škarje za pločevino • [BH] Makaze za kabal • [RU] Ножницы По Металлу Правые
- [MK] Ножици за лим зглобни, десни



Art. № L Баркод  
Art. № (mm) Barcode

370714

180

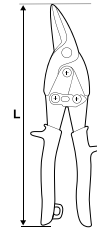

3 800123 1164699

Cr-Mo  
STEELSTEEL  
1.2mmHRC  
58-62

## COMPACT AVIATION SNIPS LEFT

- [BG] Ножица за ламарина компактна лява • [RO] Foarfeca pe stanga • [EL] Ψαλίδι λαμαρίνας αριστερό
- [PT] Tesoura corte chapa esquerda • [IT] Cesovia lamiera per taglio a sinistra • [SR] Makaze za lim zglobne leva
- [SL] Škarje za pločevino • [BH] Škare od lima kompaktne s lijeve strane
- [RU] Ножницы из листового металла компактные левые • [MK] Ножици со лим, компактен лево



Art. № L Баркод  
Art. № (mm) Barcode

370715

180

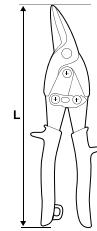

3 800123 1164705

Cr-Mo  
STEELSTEEL  
1.2mmHRC  
58-62

## COMPACT AVIATION SNIPS STRAIGHT

- [BG] Ножица за ламарина компактна права • [RO] Foarfeca din tabla dreaptă • [EL] Ψαλίδι λαμαρίνας ίσιο
- [PT] Tesoura corte chapa reta • [IT] Forbici dritte in lamiera • [SR] Makaze za lim, zglobne prave
- [SL] Škarje za pločevino • [BH] Kompaktni avionski snajpovi pravi • [RU] Ножницы из листового металла прямые
- [MK] Лист ножици директно



Art. № L Баркод  
Art. № (mm) Barcode

370716

180

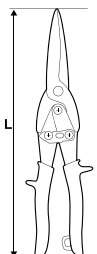

3 800123 1164712

Cr-Mo  
STEELSTEEL  
1.2mmHRC  
58-62

## TIN SNIPS RIGHT

- [BG] Ножица за ламарина дясна • [RO] Foarfeca tabla pe dreapta • [EL] Ψαλίδι λαμαρίνας δεξι • [PT] Tesoura corte chapa direita
- [IT] Cesovia lamiera DX. PRO • [SR] Makaze za lim, zglobne, desne • [SL] Škarje za pločevino • [BH] Makaze za lim
- [RU] Ножницы По Металлу Правые • [MK] Ножици за лим зглобни, десни



Art. № L Баркод  
Art. № (mm) Barcode

370511

250

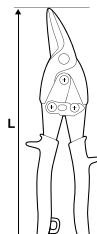

3 800123 1167676

Cr-Mo  
STEELSTEEL  
1.2mmDIN  
6438HRC  
58-62



## TIN SNIPS LEFT

- [BG] Ножица за ламарина лява • [RO] Foarfeca tabla pe stanga • [EL] Ψαλίδι λαμαρίνας αριστερό • [PT] Tesoura corte chapa esquerda
- [IT] Cesovia lamiera ST. PRO • [SR] Makaze za lim, zglobne, leve • [SL] Škarje za pločevino • [BH] Makaze za lim lijeve
- [RU] Ножницы По Металлу Левые • [MK] Ножици за лим зглобни, леви

2<sup>ND</sup>  
GENERATION

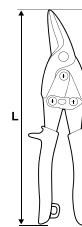

Art. № L Баркод  
Art. № (mm) Barcode

370512 250 



## TIN SNIPS STRAIGHT

- [BG] Ножица за ламарина права • [RO] Foarfeca tabla PRO • [EL] Ψαλίδι λαμαρίνας ίσιο • [PT] Tesoura corte chapa reta
- [IT] Cesovia lamiera PRO • [SR] Makaze za lim, zglobne, prave • [SL] Škarje za pločevino • [BH] Makaze za lim avijatičarske ravne
- [RU] Ножницы По Металлу Прямые • [MK] Ножици за лим зглобни, прави

2<sup>ND</sup>  
GENERATION

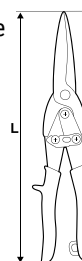

Art. № L Баркод  
Art. № (mm) Barcode

370513 250 



## TIN SNIPS RIGHT

- [BG] Ножица за ламарина дясна • [RO] Foarfeca tabla pe dreapta • [EL] Ψαλίδι λαμαρίνας δεξί
- [PT] Tesoura corte chapa direita • [IT] Cesovia lamiera DX. PRO • [SR] Makaze za lim, zglobne, desne
- [SL] Škarje za pločevino • [BH] Makaze za lim • [RU] Ножницы По Металлу Правые • [MK] Ножици за лим зглобни, десни

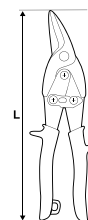

Art. № L Баркод  
Art. № (mm) Barcode

370506 250 



## TIN SNIPS LEFT

- [BG] Ножица за ламарина лява • [RO] Foarfeca tabla pe stanga • [EL] Ψαλίδι λαμαρίνας αριστερό • [PT] Tesoura corte chapa esquerda
- [IT] Cesovia lamiera ST. PRO • [SR] Makaze za lim, zglobne, leve • [SL] Škarje za pločevino • [BH] Makaze za lim lijeve
- [RU] Ножницы По Металлу Левые • [MK] Ножици за лим зглобни, леви

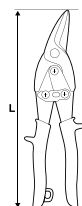

Art. № L Баркод  
Art. № (mm) Barcode

370505 250 



## TIN SNIPS STRAIGHT

- [BG] Ножица за ламарина права • [RO] Foarfeca tabla PRO • [EL] Ψαλίδι λαμαρίνας ίσιο • [PT] Tesoura corte chapa reta
- [IT] Cesovia lamiera PRO • [SR] Makaze za lim, zglobne, prave • [SL] Škarje za pločevino • [BH] Makaze za lim avijatičarske ravne
- [RU] Ножницы По Металлу Прямые • [MK] Ножици за лим зглобни, прави

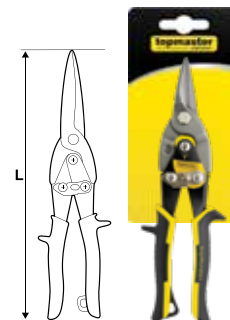

Art. №	L	Barcode
Art. №	(mm)	Barcode
370504	250	



## TIN SNIPS RIGHT

- [BG] Ножица за ламарина дясна • [RO] oarfeca tabla pe dreapta • [EL] Ψαλίδι λαμαρίνας με ελατήριο δεξί • [PT] Tesoura corte chapa direita
- [IT] Cesovia lamiera DX. PRO • [SR] Makaze za lim, desne • [SL] Škarje za pločevino • [BH] Makaze za lim
- [RU] Ножницы По Металлу Правые • [MK] Ножици за лим , десни

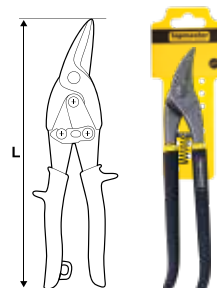

Art. №	L	Баркод
Art. №	(mm)	Barcode
370509	300	



## TIN SNIPS LEFT

- [BG] Ножица за ламарина лява • [RO] Foarfeca tabla pe stanga • [EL] Ψαλίδι λαμαρίνας με ελατήριο αριστερό • [PT] Tesoura corte chapa esquerda
- [IT] Cesovia lamiera ST. PRO • [SR] Makaze za lim, leve • [SL] Škarje za pločevino • [BH] Makaze za lim lijeve
- [RU] Ножницы По Металлу Левые • [MK] Ножици за лим , леви

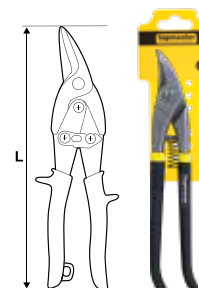

Art. №	L	Баркод
Art. №	(mm)	Barcode
370508	300	



## TIN SNIPS STRAIGHT

- [BG] Ножица за ламарина права • [RO] Foarfeca tabla PRO • [EL] Ψαλίδι λαμαρίνας με ελατήριο ίσιο • [PT] Tesoura corte chapa reta
- [IT] Cesoia lamiera PRO • [SR] Makaze za lim, prave • [SL] Škarje za pločevino • [BH] Makaze za lim avijatičarske ravne
- [RU] Ножницы По Металлу Прямые • [MK] Ножици за лим, прави

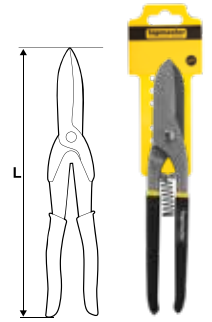

Арт. №  
Art. №

L  
(mm)

Баркод  
Barcode

370507 300



## TIN SNIPS

- [BG] Ножица за ламарина • [RO] Foarfeca tabla • [EL] Ψαλίδι λαμαρίνας με λαβή • [PT] Tesoura corte chapa • [IT] Cesoia lamiera
- [SR] Makaze za lim • [SL] Škarje za pločevino • [BH] Makaze za lim • [RU] Ножницы По Металлу • [MK] Ножици за лим

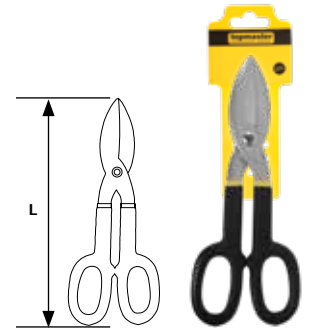

Арт. №  
Art. №

L  
(mm)

Баркод  
Barcode

370502 250



## THREADED ROD CUTTER

- [BG] Ножица за шпилки • [RO] Dispozitiv taiere bara filetata • [EL] Κόφτης ντίζας • [PT] Tesoura corte ferro • [IT] Cesoia lamiera
- [SR] Klešta za sečenje navojnih šipki • [SL] Navojni rezalnik • [BH] Rezač vijak • [RU] ШпилькоРез • [MK] Клешта за сечење



Арт. №  
Art. №

Шпилки  
(mm)

Баркод  
Barcode

370518 8-10



## BOLT CUTTER

- [BG] Ножица за арматура • [RO] Cleste taiat bolturi • [EL] Ψαλίδι μπετού • [PT] Tesoura corte ferro • [IT] Pinza tagliabulloni
- [SR] Makaze za sečenje armature • [SL] Škarje za žico • [BH] Magnetna posuda • [RU] Арматурные Ножницы
- [MK] Ножици за арматура

Арт. № Art. №	L (mm)	Ø (m)	Баркод Barcode
370801	450	6	
370802	600	8	
370803	750	10	
370804	900	12	

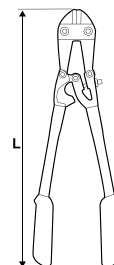

## CABLE CUTTER

- [BG] Ножица за рязане на кабел • [RO] Cleste taiat cabluri • [EL] Κόφτης καλωδίων • [PT] Alicata corta cabos • [IT] Pinza tagliacavi
- [SR] Makaze za sečenje kabla • [SL] Nož za rezanje kablov • [BH] Makaze za armaturu • [RU] Ножницы Для Резки Кабелей
- [MK] Ножици за сечење на кабел

Арт. № Art. №	L (mm)	Баркод Barcode
370805	600	
370806	800	

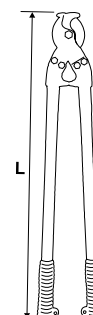

## HALF ROUND RASP

- [BG] Пила за дърво полуобла • [RO] Raspila semirotonda • [EL] Ράσπα ημιστρογγυλη με λαβή • [PT] Grosa 1/2 redonda para madeira
- [IT] Raspa per legno semitondo • [SR] Turpija za drvo poluokruga • [SL] Rašpa polkroga • [BH] Turpija za drvo poluobla
- [RU] Рашпиль По Дереву • [MK] Полукружна турпија за дрво

Арт. № Art. №	L (mm)	Баркод Barcode
360101	200	
360110	250	
360111	300	

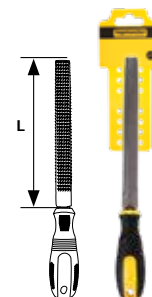



## FLAT RASP

- [BG] Пила за дърво плоска • [RO] Raspila plata • [EL] Ράσπα πλακέ με λαβή • [PT] Grosse plana para madeira
- [IT] Raspa per legno tondo rettangolare • [SR] Turpija za drvo ravna • [SL] Rašpa ploščata • [BH] Turpija za drvo obla
- [RU] Плоский Рашпиль По Дереву • [MK] Плосната турпија за дрво

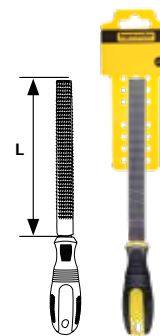

Art. № L Баркод  
Art. № (mm) Barcode

360102 200



## ROUND RASP

- [BG] Пила за дърво обла • [RO] Raspila rotunda • [EL] Ράσπα στρόγγυλη με λαβή • [PT] Grosse redonda para madeira
- [IT] Raspa per legno tondo • [SR] Turpija za drvo okrugla • [SL] Rašpa okrogla • [BH] Turpija zašiljena
- [RU] Рашпиль По Дереву • [MK] Округла турпија

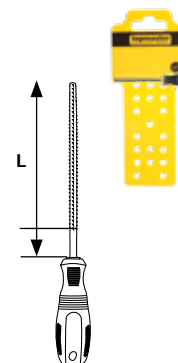

Art. № L Баркод  
Art. № (mm) Barcode

360103 200



## WOOD FILE SET

- [BG] Пили за дърво комплект • [RO] Set raspile • [EL] Ράσπες με λαβή σετ • [PT] Jogo de grosas para madeira - Redonda • [IT] Raspe set
- [SR] Set turpija za drvo • [SL] Rašpe v garnituri • [BH] Turpija za drvo pljosnata • [RU] Комплект Рашпелей По Дереву
- [MK] Гарнитура турпии

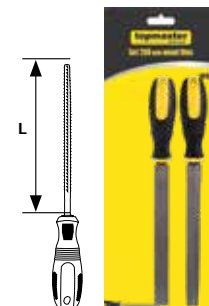

Art. № L Баркод  
Art. № (mm) Barcode

360109 200



## FLAT FILE

- [BG] Пила за метал плоска • [RO] Pila dreptunghiulara • [EL] Λίμα πλακέ με λαβή • [PT] Lima plana para metal
- [IT] Lima per metallo rettangolare • [SR] Turpija za metal prava • [SL] Pila ploščata • [BH] Turpija za metal obla
- [RU] Рашпиль По Металлу • [MK] Плосната турпија

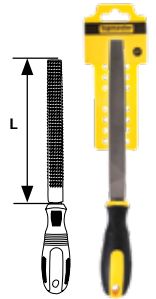

Арт. № Art. №	L (mm)	Баркод Barcode
360501	200	
360517	250	
360518	300	



## HALF ROUND FILE

- [BG] Пила за метал полуобла • [RO] Pila semirotunda • [EL] Λίμα ημιστρούγκυλη με λαβή • [PT] Lima 1/2 redonda para metal
- [IT] Lima per metallo semitonda • [SR] Turpija za metal poluokrugla • [SL] Pila polkrogla • [BH] Turpija za metal pljosnata
- [RU] Рашпиль По Металлу • [MK] Полукружна турпија

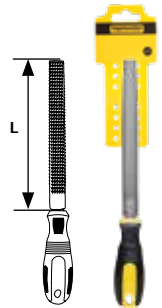

Арт. № Art. №	L (mm)	Баркод Barcode
360502	200	



## SQUARE FILE

- [BG] Пила за метал квадратна • [RO] Pila patrata • [EL] Λίμα τετράγωνη με λαβή • [PT] Lima quadrada para metal • [IT] Lima
- [SR] Turpija za metal kvadratna • [SL] Pila kvadratna • [BH] Torbica za alat gadgetkožna sa pojasom
- [RU] Квадратный Рашпиль По Металлу • [MK] Четвртатста турпија

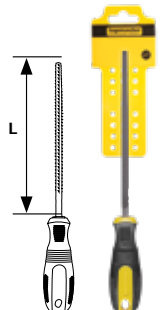

Арт. № Art. №	L (mm)	Баркод Barcode
360505	200	



## ROUND RASP FILE

- [BG] Пила за метал обла • [RO] Pila rotunda • [EL] Λίμα στρόγγυλη με λαβή • [PT] Lima redonda para metal
- [IT] Lima per metallo tonda • [SR] Turpija za metal okrugla • [SL] Pila okrogla • [BH] Turpija za drvo poluobla
- [RU] Рашпиль По Металлу • [MK] Округла турпија

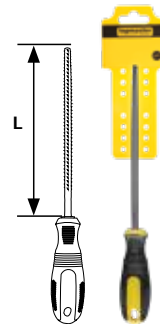

Art. №  
Art. №      L  
                  (mm)      Баркод  
   Barcode

360504      200



## TAPER FILE

- [BG] Пила за метал триъгълна • [RO] Pila triunghiulara • [EL] Λίμα τρίγωνη με λαβή • [PT] Lima triangular para metal
- [IT] Lima triangolare • [SR] Turpija za metal trouglasta • [SL] Pila trikotna • [BH] Turpija obla I poluobla
- [RU] Тiuгольный Рашпиль По Металлу • [MK] Триаголна турпија

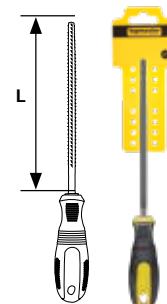

Art. №  
Art. №      L  
                  (mm)      Баркод  
   Barcode

360503      200



## SLIM TAPER FILE

- [BG] Пила за метал триъгълна фина • [RO] Pila triunghiulara • [EL] Λίμα τρίγωνη ψιλή με λαβή • [PT] Lima triangular para metal
- [IT] Lima triangolare • [SR] Turpija za metal trouglasta uska • [SL] Pila trikotna • [BH] Turpija obla I poluobla
- [RU] Рашпиль По Металлу • [MK] Триаголна турпија

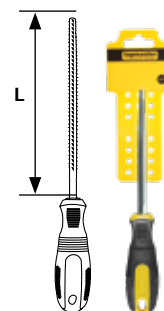

Art. №  
Art. №      L  
                  (mm)      Баркод  
   Barcode

360519      150



360520      200



## WOOD FILE SET

- [BG] Пили за метал комплект • [RO] Set 3 pile maner bi-material • [EL] Λίμες με λαβή σετ • [PT] Jogo de limas para metal - Redonda
- [IT] Lime manico legno set • [SR] Set turpija za metal • [SL] Pile v garnituri • [BH] Turpija set
- [RU] Набор Рашпелей По Металлу • [МК] Гарнитура турпии

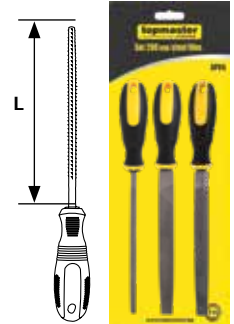

Арт. № Art. №	L (mm)	Баркод Barcode
360511	200	



## CHAIN SAW FILE

- [BG] Пила за верижен трион • [RO] Pila lant drujba • [EL] Λίμα αλυσοπριόνου με λαβή • [PT] Lima para serra
- [IT] Lima per catena motosega • [SR] Turpija za lanac • [SL] Pila za motorno žago • [BH] Turpija za metal obla
- [RU] Напильник • [МК] Турпија

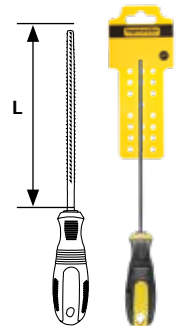

Арт. № Art. №	L (mm)	Ø (mm)	Баркод Barcode
360512	200	4.0	
360513	200	4.5	
360515	200	4.8	



## CHAIN SAW FILE SET

- [BG] Пили за верижен трион к-т • [RO] Set 2 pile lant drujba • [EL] Λίμα αλυσοπριόνου σετ 2τμχ • [PT] Lima para serra
- [IT] Lima per catena motosega set • [SR] Okrugle turpije za oštrenje lanaca • [SL] Pila za motorno žago
- [BH] Turpija za metal obla • [RU] Набор Напильников • [МК] Гарнитура турпии

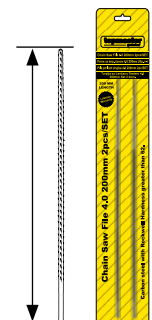

Арт. № Art. №	L (mm)	Ø (mm)	Баркод Barcode
360516	200	4	





## SET DIAMOND FILES

- [BG] Пили диамантени комплект • [RO] Set 6 pile diamantate • [EL] Λίμες με λαβή σέτ 6τμχ • [PT] Jogo de grosas / limas • [IT] Lime set
- [SR] Set turpija igličastih za metal • [SL] Pila v garnituri • [BH] Turpija četvrtasta
- [RU] Набор Алмазных Напильников • [MK] Гарнитура турпии



Арт. № Art. №	L (mm)	Баркод Barcode
------------------	-----------	-------------------

360514

140



3 80012311545601



## COMBINATION PLANE-RASP

- [BG] Ренде универсално • [RO] Rindea gips carton maner plastic • [EL] Ράσπα πλάνη πλαστική
- [PT] Grosa redonda para gesso cartonado • [IT] Piella cartongesso manico plastica • [SR] Rašpa univerzalna jednoručna • [SL] Strgalo
- [BH] Raspa • [RU] Универсальный Рубанок • [MK] Стругалка

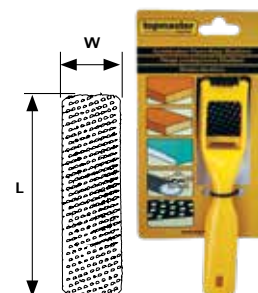

Арт. № Art. №	W (mm)	L (mm)	Баркод Barcode
------------------	-----------	-----------	-------------------

350502

40

60



3 80012311208311

## COMBINATION PLANE-RASP

- [BG] Ренде универсално • [RO] Rindea gips carton maner plastic • [EL] Ράσπα πλάνη πλαστική
- [PT] Grosa redonda para gesso cartonado • [IT] Piaalla cartongesso manico plastica • [SR] Rašpa univerzalna jednoručna • [SL] Strgalo
- [BH] Raspa • [RU] Универсальный Рубанок • [MK] Стругалка

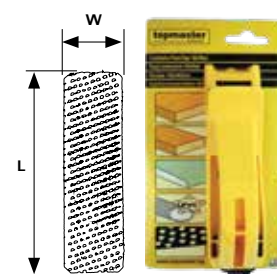

Арт. № Art. №	W (mm)	L (mm)	Баркод Barcode
350503	40	140	

## COMBINATION PLANE-RASP

- [BG] Ренде универсално • [RO] Rindea gips carton maner plastic • [EL] Ράσπα πλάνη πλαστική
- [PT] Grosa redonda para gesso cartonado • [IT] Piaalla cartongesso manico plastica • [SR] Rašpa univerzalna jednoručna • [SL] Strgalo
- [BH] Raspa • [RU] Универсальный Рубанок • [MK] Стругалка

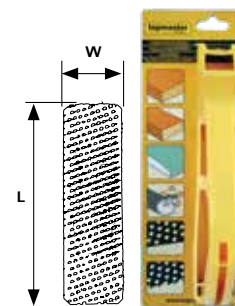

Арт. № Art. №	W (mm)	L (mm)	Баркод Barcode
350512	40	250	

## COMBINATION PLANE-RASP

- [BG] Ренде универсално • [RO] Rindea metalica gips carton maner plastic • [EL] Ράσπα πλάνη μονή λαβή
- [PT] Grosa plana duas mãos • [IT] Pialla metallica manico • [SR] Rašpa univerzalna metalna • [SL] Strgalo • [BH] Raspa
- [RU] Универсальный Рубанок • [MK] Стругалка



Art. № Art. №	W (mm)	L (mm)	Баркод Barcode
------------------	-----------	-----------	-------------------

350509	40	250	
--------	----	-----	--

## COMBINATION PLANE-RASP

- [BG] Ренде универсално • [RO] Rindea gips carton maner lemn • [EL] Ράσπα πλάνη διπλή λαβή
- [PT] Grosa plana duas mãos • [IT] Pialla metallica manico • [SR] Rašpa univerzalna metalna • [SL] Strgalo • [BH] Raspa
- [RU] Универсальный Рубанок • [MK] Стругалка



Art. № Art. №	W (mm)	L (mm)	Баркод Barcode
------------------	-----------	-----------	-------------------

350508	40	250	
--------	----	-----	--

## COMBINATION PLANE-RASP

- [BG] Ренде ръчно универсално • [RO] Rindea metalica gips carton • [EL] Ράσπα πλάνη μεταλλική
- [PT] Grosa plana duas mãos • [IT] Piatta metallica manico plastico • [SR] Rašpa univerzalna metalna • [SL] Strgalo
- [BH] Raspa • [RU] Универсальный Рубанок • [MK] Стругалка

Art. № Art. №	W (mm)	L (mm)	Баркод Barcode
350510	40	250	

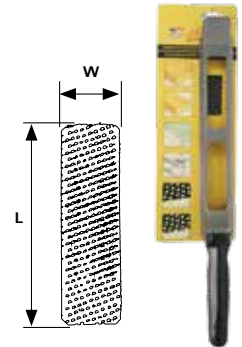

## RASP

- [BG] Нож за ренде • [RO] Rezerva rindea rigips • [EL] Λάμα ράσπας πλάνη • [PT] Grosa • [IT] Piatta di cambio cartongesso
- [SR] Nož uložak rezervni za rašpu • [SL] Rezilo za strgalo • [BH] Raspa • [RU] Нож Для Рубанка • [MK] Резервно ренде

Art. № Art. №	W (mm)	L (mm)	Баркод Barcode
350506	40	140	
350511	40	250	

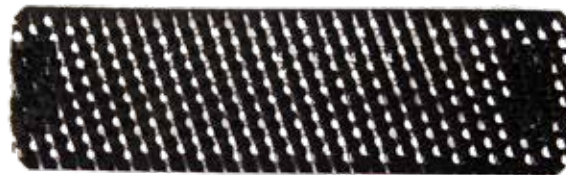

## STEEL WIRE BRUSH

- [BG] Четка телена • [RO] Perie sarma maner bi-material • [EL] Συρματόβουρτσα 2 υλικών(inox-ναϋλον) • [PT] Escova de aço
- [IT] Spazzola metallica con manico bi-materiale • [SR] Četka čelična Bi drška • [SL] Žična krtača • [BH] Čelična četka
- [RU] Проволочная Щетка • [MK] Жичана четка

Art. № Art. №	L (mm)	Баркод Barcode
390800	200	





## STEEL WIRE BRUSH

- [BG] Четка телена • [RO] erie sarma maner bi-material • [EL] Συρματόβουρτσα • [PT] Escova de aço
- [IT] Spazzola metallica con manico bi-materiale • [SR] Četka čelična Bi drška • [SL] Žična krtača • [BH] Čelična četka
- [RU] Проволочная Щетка • [MK] Жичана четка



Art. № Art. №	L (mm)	Баркод Barcode
390801	250	



## STEEL WIRE BRUSH

- [BG] Четка телена неръждаема стомана • [RO] Perie sarma maner bi-material • [EL] Συρματόβουρτσα inox • [PT] Escova aço
- [IT] Spazzola metallica con manico bi-materiale • [SR] Četka čelična Bi drška • [SL] Žična krtača • [BH] Čelična četka
- [RU] Стальная Проволочная Щетка • [MK] Жичана четка



Art. № Art. №	L (mm)	Баркод Barcode
390802	250	



## STEEL WIRE BRUSH

- [BG] Четка телена месинг със стъргало • [RO] Perie sarma maner bi-material cu razuitoar • [EL] Συρματόβουρτσα ορειχάλκινη
- [PT] Escova latão • [IT] Spazzola metallica con manico bi-materiale con raschiatore • [SR] Četka čelična Bi drška, mesing • [SL] Žična krtača
- [BH] Čelična četka • [RU] Латунная Проволочная Щетка • [MK] Жичана четка



Art. № Art. №	L (mm)	Баркод Barcode
390803	350	



8

*ТАКЕРИ И НИТАЧКИ*  
*FASTENING TOOLS*

# STAPLE GUN

- [BG] Такер усилен 4 в 1 • [RO] Capsator aluminiu 4 in 1 • [EL] Πιστόλι καρφωτικό αλουμινίου • [PT] Agrafador 4 em 1
- [IT] Pinzatrice alluminio 4 in 1 • [SR] Heftalica ručna PVC • [SL] Spenjač • [BH] Kamen za oštrenje
- [RU] Алюминиевый Степлер • [MK] Хефталка



Art. №	Ra	Баркод
Art. №	(mm)	Barcode
491115	6-14	

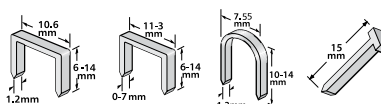

# STAPLE GUN

- [BG] Такер алуминиев • [RO] Capsator 4 in 1 • [EL] Πιστόλι καρφωτικό αλουμινίου • [PT] Agrafador 4 em 1 • [IT] Pinzatrice 4 in 1
- [SR] Heftalica ručna metalna • [SL] Spenjač • [BH] Kamen za oštrenje
- [RU] Степлер • [MK] Хефталка



Art. №	Ra	Баркод
Art. №	(mm)	Barcode
491116	6-14	

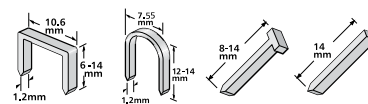

# STAPLE GUN

- [BG] Такер усилен метален 4 функции • [RO] Capsator 4 in 1 • [EL] Πιστόλι καρφωτικό • [PT] Agrafador metálico 4 em 1
- [IT] Pinzatrice metallica • [SR] Heftalica ručna sa 4 funkcije • [SL] Spenjač • [BH] Kamen za oštrenje
- [RU] Усиленный Степлер • [MK] Хефталка



Art. №	Ra	Баркод
Art. №	(mm)	Barcode
491113	4-14	

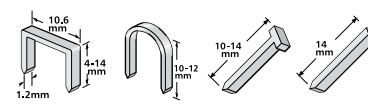

# STAPLES

- [BG] Скоби за такер • [RO] Set capse tapiterie • [EL] Καρφωτικά δίχαλα • [PT] Agrafos set • [IT] Punti metallici tappezzeria set
- [SR] Municija za heftalicu rak • [SL] Sponke • [BH] Set sprajalica • [RU] Скобы Для Степлера • [MK] Иглици за хефталка

Арт. № Art. №	H (mm)	Баркод Barcode
511319	6	
511320	8	
511321	10	
511322	12	
511323	14	
511324	16	



\*Suitable for all models



# STAPLES

- [BG] Скоби за такер • [RO] Set capse tapiterie • [EL] Καρφωτικά δίχαλα • [PT] Agrafos set • [IT] Punti metallici tappezzeria set
- [SR] Municija za heftalicu rak • [SL] Sponke • [BH] Set sprajalica • [RU] Скобы Для Степлера • [MK] Иглици за хефталка

Арт. № Art. №	H (mm)	Баркод Barcode
511331	6	
511332	8	
511333	10	
511334	12	
511335	14	



\*Suitable for all models



# STAPLES

- [BG] Скоби за такер • [RO] Set capse tapiterie • [EL] Καρφωτικά δίχαλα • [PT] Agrafos set • [IT] Punti metallici tappezzeria set
- [SR] Municija za heftalicu rak • [SL] Sponke • [BH] Set sprajalica • [RU] Скобы Для Степлера • [MK] Иглици за хефталка

Арт. № Art. №	H (mm)	Баркод Barcode
511336	10	
511337	12	
511338	14	



\* Suitable for models 491115 and 491116





# STAPLES

- [BG] Скоби за такер • [RO] Set capse tapiterie • [EL] Καρφωτικά δίχαλα • [PT] Agrafos set • [IT] Punti metallici tappezzeria set
- [SR] Municija za heftalicu pak • [SL] Sponke • [BH] Set sprajalica • [RU] Скобы Для Степлера • [MK] Иглици за хефталка

Art. № Art. №	H (m)	Баркод Barcode
493201	10	
493202	12	
493203	14	

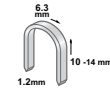

\*From topmaster range - suitable for models 491113



# BRADS NAIL

- [BG] Пирони за такер • [RO] Set cuie • [EL] Καρφωτικά βελονάκι • [PT] Pregos • [IT] Set chiodi • [SR] Ekseri za heftalicu • [SL] Sponke
- [BH] Sprajalica i čavlića • [RU] Гвозди Для Степлера • [MK] Иглици за хефталка

Art. № Art. №	H (mm)	Баркод Barcode
511339	10	
511340	12	
511341	15	



# HAND RIVETER

- [BG] Нитачка подсилена алумин. дръжка • [RO] Pistol pop-nituri • [EL] Περτσιναδόρος • [PT] Alicates de rebitar alumínio
- [IT] Pistola rivettatrice • [SR] Klešta za pop nitne • [SL] Pištola za zakovice • [BH] Pila za sipreks
- [RU] Усиленный Заклепочник • [MK] Клешти за поп нитни

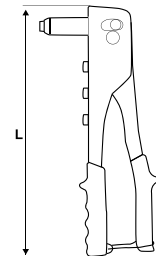

Art. № Art. №	L (mm)	Баркод Barcode
491111	270	



# HAND RIVETER

- [BG] Нитачка алуминиева • [RO] Pistol pop-nituri • [EL] Περτσινιδόρος • [PT] Alicates de rebitar • [IT] Pistola rivettatrice
- [SR] Klešta za pop nitne • [SL] Pištola za zakovice • [BH] Pila za siporeks • [RU] Усиленный Заклепочник • [MK] Клешти за поп нитни

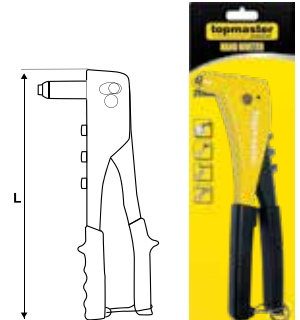

Art. № Art. №	L (mm)	Баркод Barcode
491114	255	

Ø2.4 Ac/Al, Ø3-3.2 Ac/Al,  
Ø4 Ac/Al, Ø4.8 Al  
Wrench included



# HAND RIVETER

- [BG] Нитачка алуминиева • [RO] Pistol pop-nituri • [EL] Περτσινιδόρος • [PT] Alicates de rebitar • [IT] Pistola rivettatrice
- [SR] Klešta za pop nitne • [SL] Pištola za zakovice • [BH] Pila za siporeks • [RU] Усиленный Заклепочник • [MK] Клешти за поп нитни



Art. № Art. №	L (mm)	Баркод Barcode
491155	250	

Ø2.4 Ac/Al, Ø3-3.2 Ac/Al, Ø4 Ac/Al, Ø4.8 Al



# NUT RIVETER

- [BG] Нитачка за нит - гайки • [RO] Cleste piulite nit • [EL] Περσιναδόρος • [PT] Alicates de rebitar
- [IT] Pistola rivettatrice • [SR] Klešta za pop nitne • [SL] Pištola za zakovice • [BH] Pila za siporeks
- [RU] Усиленный заклепочник • [MK] Клешти за поп нитни



Ø2.4 Ac/Al  
Ø3-3.2 Ac/Al  
Ø4 Ac/Al  
Ø4.8 Al

Art. № Art. №	L (mm)	Баркод Barcode
491100	190	



1 Open the handles, put a nut in the screw stem, then insert it into the riveting hole. The handles need to be fully open when putting the nut on the rivet nut screw stem. Open the handles.



2 Screw the nut into the mandrel



3 Close the handles. Close the handles & rivet the nut into place



4 Rotate the knob counterclockwise in order to remove the rivet after riveting

Wrench included



# LEVER RIVETER

- [BG] Нитачка лоства • [RO] Cleste nituri pop • [EL] Περσιναδόρος φαλιδιωτός • [PT] Alicates de rebitar braços longos
- [IT] Pinza rivettatrice • [SR] Klešta za pop nitne dvoručna • [SL] Čelni za zakovice • [BH] Pila za siporeks • [RU] Заклепочник
- [MK] Клешти за поп нитни со сад за отпад

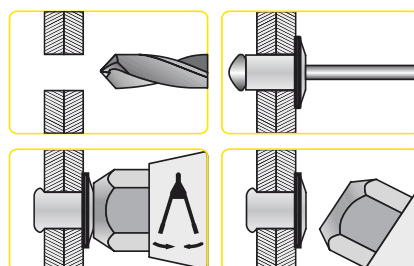
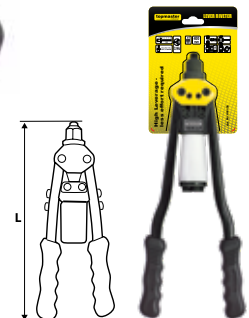

Ø2.4 Ac/Al  
Ø3.2 Ac/Al  
Ø4 Ac/Al  
Ø4.8 Ac/Al  
Ø6.4 Ac/Al

Art. № Art. №	L (mm)	Баркод Barcode
491156	400	



# 9

**СТРОИТЕЛСТВО**  
**BUILDING TOOLS**





## SCRAPER TPR HANDLE

- [BG] Шпакла двукомпонентна дръжка
- [RO] Spaclu maner plastic
- [EL] Στοκαδόρος με πλαστική λαβή
- [PT] Espátula com punho plástico
- [IT] Raschietto con manico di plastica
- [SR] Špahtla sa plastičnom drškom
- [SL] Lopatica pleskarska
- [BH] Špahtla lopatica
- [RU] Шпатель малярный
- [MK] Шпакла

арт. № art. №	W (mm)	Баркод Barcode
320713	25	
320708	40	
320709	50	
320714	65	
320710	80	
320715	100	
320712	127	



## MULTI SCRAPER WITH BIT

- [BG] Шпакла мултифункционална с накрайник
- [RO] Spaclu maner plastic
- [EL] Ξύστρα inox πολλαπλών χρήσεων
- [PT] Espátula multifunções
- [IT] Raschietto multifunzione 5 in 1 manico
- [SR] Špahtla, višenamenska
- [SL] Strgalo
- [BH] Strugač
- [RU] Шпатель малярный
- [MK] Шпакла



арт. № art. №	W (mm)	Баркод Barcode
320719	75	



## SCRAPER WITH BIT

- [BG] Шпакла с накрайник
- [RO] Spaclu maner plastic
- [EL] Σπάτουλα και ξύστρα πολλαπλών χρήσεων
- [PT] Espátula multifunções
- [IT] Raschietto multifunzione 5 in 1 manico
- [SR] Špahtla, višenamenska
- [SL] Lopatica pleskarska
- [BH] Strugač
- [RU] Шпатель малярный
- [MK] Шпакла





арт. № art. №	W (mm)	Баркод Barcode
320722	125	



## SCRAPER TPR HANDLE

- [BG] Шпакла двукомпонентна дръжка • [RO] Spaclu maner plastic • [EL] Σπαρουλαδόρος με πλαστική λαβή • [PT] Espátula com punho plástico
- [IT] Raschietto con manico di plastica • [SR] Špahlta sa dvokomponentnom drškom • [SL] Lopatica gladka • [BH] Strugač
- [RU] Шпатель малярный • [MK] Шпакла

арт. № art. №	W (mm)	Баркод Barcode
320716	160	
320717	180	
320718	200	

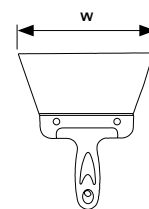

## PLASTRING TROWEL

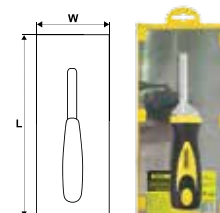

- [BG] Маламашка двукомпонентна дръжка • [RO] Gletiera inox • [EL] Σπάτουλα κόλλας χωρίς δόντι • [PT] Espátula ladrilhador
- [IT] Frattazzo dentato a manico di plastica • [SR] Gleterica sa dvokomponentnom drškom
- [SL] Gladilka • [BH] Gleter nazubljeni • [RU] Терка • [MK] Глетувалка, пластична дршка

арт. № art. №	L (mm)	W (mm)	Баркод Barcode
320114	280	130	



## PLASTRING TROWEL

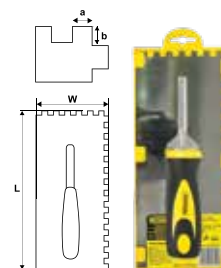

- [BG] Маламашка двукомпонентна дръжка • [RO] Gletiera inox • [EL] Σπάτουλα κόλλας με δόντι
- [PT] Espátula ladrilhador • [IT] Frattazzo dentato a manico di plastica • [SR] Gleterica sa dvokomponentnom drškom
- [SL] Gladilka • [BH] Gleter nazubljeni • [RU] Терка • [MK] Глетувалка, пластична дршка

арт. № art. №	L (mm)	W (mm)	ab (mm)	Баркод Barcode
320113	280	130	6	
320127	280	130	8	
320128	280	130	10	



## PLASTRING TROWEL WOOD HANDLE

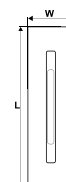

- [BG] Маламашка дървена дръжка • [RO] Gletiera maner lemn • [EL] Σπάτουλα κόλλας χωρίς δόντι • [PT] Espátula ladrilhador lisa
- [IT] Frattazzo a manico in legno senza denti • [SR] Gleterica sa drvenom drškom • [SL] Gladilka • [BH] Gleter • [RU] Терка
- [MK] Глетувалка

арт. № art. №	L (mm)	W (mm)	Баркод Barcode
320124	480	130	
320125	600	130	



## BRICKLAYING TROWEL

- [BG] Мистрия двукомпонентна дръжка • [RO] Mistrie dreapta cu maner plastic • [EL] Μυστρί κοφτό με πλαστική λαβή
- [PT] Colher tipo espátula • [IT] Cazzuola a punta quadra • [SR] Mistrinja četvrtasta • [SL] Žlica zidarska
- [BH] Žlica gipserska • [RU] Кельма штукатурная • [MK] Мистрија

арт. № art. №	L (mm)	L <sub>1</sub> (mm)	Баркод Barcode
323301	100	60	
323302	110	80	
323303	120	100	

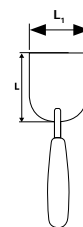

## BRICKLAYING TROWEL

- [BG] Мистрия двукомпонентна дръжка • [RO] Mistrie dreapta cu maner plastic • [EL] Μυστρί κοφτό με πλαστική λαβή
- [PT] Colher tipo espátula • [IT] Cazzuola a punta quadra • [SR] Mistrinja četvrtasta • [SL] Žlica zidarska
- [BH] Žlica gipserska • [RU] Кельма штукатурная • [MK] Четвртатста мистрија

арт. № art. №	L (mm)	L <sub>1</sub> (mm)	Баркод Barcode
323304	160	60	
320111	180	80	

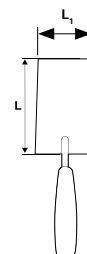

## BRICKLAYING TROWEL

- [BG] Мистрия двукомпонентна дръжка • [RO] Mistrie dreapta cu maner plastic • [EL] Μυστρί σοφатζήδων με πλαστική λαβή
- [PT] Colher tipo espátula • [IT] Cazzuola a punta quadra • [SR] Mistrinja poluokrugla • [SL] Žlica zidarska • [BH] Žlica gipserska
- [RU] Кельма штукатурная • [MK] Мистрија

арт. № art. №	L (mm)	Баркод Barcode
320119	180	
320120	200	

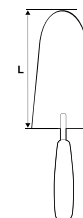

## MAGNETIC WRIST HOLDER

- [BG] Магнитна гривна - държач • [RO] Bratară magnetica • [EL] Μαγνητική θήκη καρπού • [PT] Suporte de pulso magnético • [IT] Polso magnetico
- [SR] Magnetski držač za zglobov • [SL] Magnetna zapestja • [BH] Magnetni držač za zglobov • [RU] Магнитный держатель запястья
- [MK] Магнетна нараквица

арт. № art. №	Баркод Barcode
460101	



## BRICKLAYING TROWEL TRAPEZE

- [BG] Мистрия двукомпонентна дръжка • [RO] Mistrie dreapta cu maner plastic • [EL] Μυστρί κοφτό με πλαστική λαβή
- [PT] Colher tipo espátul • [IT] Cazzuola a punta quadr • [SR] Mistrija četvrtast • [SL] Žlica zidarska • [BH] Dvokomponentna drška za glavicu
- [RU] Мастерок двухкомпонентная ручка • [MK] Мистрија рачка од две компоненти

2<sup>ND</sup>  
GENERATION

арт. № art. №	L (mm)	Баркод Barcode
323112	160	
323100	180	

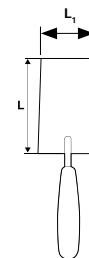

STAINLESS  
STEEL TPR

## BRICKLAYING TROWEL ROUNDED

- [BG] Мистрия обла двукомпонентна дръжка • [RO] Mistrie dreapta cu maner plastic • [EL] Μυστρί σοφατζήδων με πλαστική λαβή
- [PT] Colher tipo espátul • [IT] Cazzuola a punta quadr • [SR] Mistrija poluokrugi • [SL] Žlica zidarska • [BH] Lopata ima dvokomponentnu dršku
- [RU] Кельма имеет двухкомпонентную ручку • [MK] Мистрија има рачка од две компоненти

2<sup>ND</sup>  
GENERATION

арт. № art. №	L (mm)	Баркод Barcode
323103	180	
323104	200	

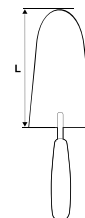

STAINLESS  
STEEL TPR

## BRICKLAYING TROWEL

- [BG] Мистрия двукомпонентна дръжка • [RO] Mistrie dreapta cu maner plastic • [EL] Μυστρί κοφτό με πλαστική λαβή
- [PT] Colher tipo espátul • [IT] Cazzuola a punta quadr • [SR] Mistrija četvrtast • [SL] Žlica zidarska • [BH] Dvokomponentna drška za glavicu
- [RU] Мастерок двухкомпонентная ручка • [MK] Мистрија рачка од две компоненти

2<sup>ND</sup>  
GENERATION

арт. № art. №	size (mm)	Баркод Barcode
323109	60x100	
323110	80x110	
323111	100x120	

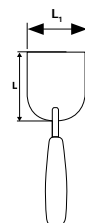
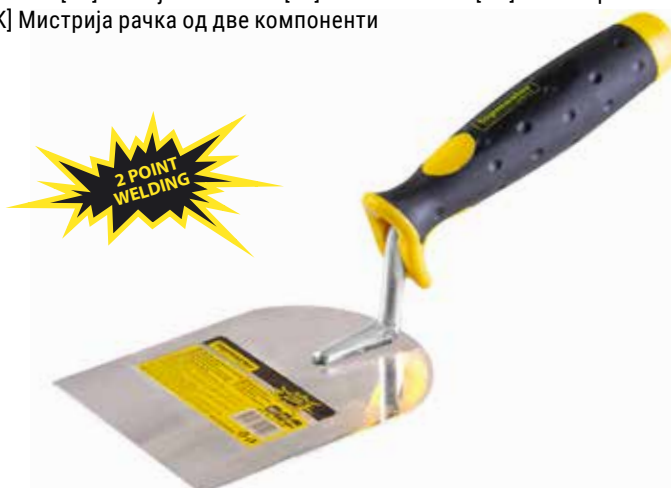

STAINLESS  
STEEL TPR



## PLASTRING TROWEL

- [BG] Маламашка двукомпонентна дръжка • [RO] Gletiera inox • [EL] Σπάτουλα κόλλας χωρίς δόντι
- [PT] Espátula ladrilhador • [IT] Frattazzo dentato a manico di plastica • [SR] Gleterica sa dvokomponentnom drškom • [SL] Gladilka
- [BH] Dvodelna drška za glačanje • [RU] Мастерок из двух частей • [MK] Мистрија рачка со две парчиња

2<sup>ND</sup>  
GENERATION

арт. № art. №	size (mm)	Баркод Barcode
323101	280x130	 3 800972 015005





STAINLESS  
STEEL

TPR

## PLASTRING TROWEL

- [BG] Маламашка двукомпонентна дръжка • [RO] Gletiera inox • [EL] Σπάτουλα κόλλας με δόντι
- [PT] Espátula ladrilhador • [IT] Frattazzo dentato a manico di plastica • [SR] Gleterica sa dvokomponentnom drškom
- [SL] Gladilka • [BH] Gleter nazubljeni • [RU] Терка • [MK] Глетувалка, пластична дръшка

2<sup>ND</sup>  
GENERATION

арт. № art. №	L (mm)	W (mm)	ab (mm)	Баркод Barcode
323107	280	130	6	 3 800972 015067
323106	280	130	8	 3 800972 015050
323108	280	130	10	 3 800972 015074

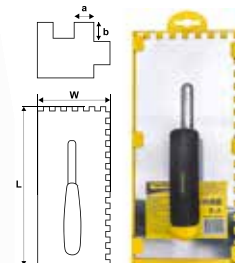

STAINLESS  
STEEL

TPR

## PLASTRING TROWEL WOOD HANDLE

- [BG] Маламашка дървена дръжка • [RO] Gletiera maner lemn • [EL] Σπάτουλα κόλλας χωρίς δόντι • [PT] Espátula ladrilhador lisa
- [IT] Frattazzo a manico in legno senza denti • [SR] Gleterica sa drvenom drškom • [SL] Gladilka • [BH] Gleter • [RU] Терка
- [MK] Глетувалка

2<sup>ND</sup>  
GENERATION

арт. № art. №	L (mm)	W (mm)	Баркод Barcode
323105	480	130	 3 800972 015043

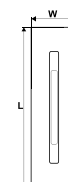



STAINLESS  
STEEL

TPR

## BAR CLAMP SPEED TYPE 2 IN 1

- [BG] Стяга бърз захват 2 в 1 • [RO] Presa manuala rapidă 2 in 1 • [EL] Σφιγκτήρας ενός χεριού 2 σε 1 • [PT] Grampo de aperto rápido tipo 2 em 1
- [IT] Morsa 2 in 1 • [SR] Stolarska stega brza • [SL] Spona hitra • [BH] Stega stolarska topmaster žuta drška
- [RU] Струбцина автоматическая 2 в 1 • [MK] Столарска стега 2 в 1

арт. № art. №	L (mm)	W (mm)	L1 (mm)	Баркод Barcode
250510	150	85	180 - 350	
250511	300	85	180 - 500	
250512	450	85	180 - 660	

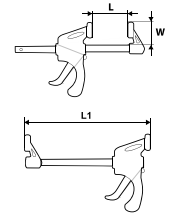

## F-CLAMP TPR HANDLE

- [BG] Стяга дърводелска • [RO] Ranga pentru scos cuie • [EL] Σφιγκτήρας μαραγκών • [PT] Grampo de aperto com parafuso • [IT] Pressa manuale
- [SR] Stolarska stega • [SL] Mizarska spona • [BH] Stega stolarska • [RU] Струбцина столярная • [MK] Столарска стега

арт. № art. №	L (mm)	W (mm)	Баркод Barcode
250206	150	60	
250207	200	60	
250208	250	80	
250209	300	80	
250201	400	120	
250202	500	120	
250203	600	120	



250204	800	120	
250205	1000	120	
250210	1200	120	
250200	1500	120	

RIVET

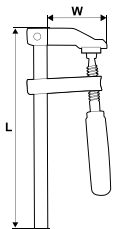
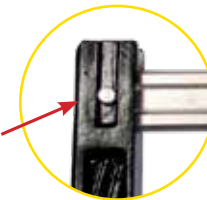

## WRECKING BAR

- [BG] Щанга - тип "кози крак" • [RO] Ranga pentru scos cuie • [EL] Προκοβγάλης • [PT] Barra de demolição • [IT] Barra di demolizione
- [SR] Pajser • [SL] Odpiráč • [BH] Poluga • [RU] Лом • [MK] Хебла

арт. № art. №	L (mm)	H (mm)	W (mm)	Баркод Barcode
260000	455	25	12	



## PROFILED WRECKING BAR

- [BG] Щанга - тип "кози крак" • [RO] Ranga pentru scos cuie • [EL] Προκοβγάλης • [PT] Barra de demolição • [IT] Barra di demolizione
- [SR] Pajser • [SL] Odpiráč • [BH] Poluga • [RU] Лом • [MK] Хебла

арт. № art. №	L (mm)	H (mm)	W (mm)	Баркод Barcode
260001	600	30	17	
260002	760	30	17	
260003	900	30	17	

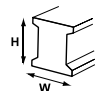

## HIGH SECURITY LOCK

- [BG] Катинар ямков • [RO] Lacat • [EL] Λουκέτο ατσάλινο • [PT] Cadeado • [IT] lucchetto • [SR] Katanac • [SL] Ključavnica
- [BH] Padlock • [RU] Замок навесной латунный • [MK] Катанец со безбедносен дел

арт. № art. №	(mm)	Баркод Barcode	арт. № art. №	(mm)	Баркод Barcode
500101	40		500103	60	
500102	50				



## BRASS PAD LOCK

- [BG] Катинар месинг • [RO] Lacat Galben Patrat • [EL] Λουκέτο τάκος • [PT] Cadeado • [IT] lucchetto • [SR] Katanac
- [SL] Ključavnica • [BH] Padlock • [RU] Замок навесной латунный • [MK] Катанец со безбедносен дел

арт. № art. №	Размер / Size (mm)	Баркод Barcode
500301	70	
500302	80	



## CRAPENTER PENCILS & SHARPENER SET

- [BG] Моливи дърводелски и острилка • [RO] Set creioane tamplar si ascutitoare • [EL] Μολύβια μαραγκών σετ
- [PT] Lápis de carpinteiro com bainha e afiã • [IT] Matite per falegname + temperamatite kit • [SR] Tesarska olovka + rezač
- [SL] Tesarski svinčnik set • [BH] Olovke za bušenje • [RU] Карандаш столярный • [MK] Гарнитура столарски моливи со острилка

арт. № art. №	Баркод Barcode
549938	



## LINE REEL

- [BG] Шнур зидарски с въртяща се дръжка • [RO] Sfoara de trasat • [EL] Ράματα μαστόρων χεριού • [PT] Barra "Pé de Cabra"
- [IT] Leva per chiodi tipo • [SR] Канар zidarski • [SL] Zidarska vrv • [RU] Шнур разметочный каменщика • [MK] Зидарски канар

арт. № art. №	Баркод Barcode
320905	



## CHALK LINE & POWDERED CHALK

- [BG] Маркираща линия комплект • [RO] Set sfoara de trasat si creta • [EL] Ράμα μαστόρων σηματούρα • [PT] Bate linhas e pó
- [IT] Filo e gessetto per tracciare le linee • [SR] Prah i konac za obeležavanje • [SL] Kreda za označevanje
- [RU] Мел для маркировки • [MK] Прав за обележување

арт. № art. №	Баркод Barcode
289908	
289910*	



\*Креда за маркираща линия

## POLYURETHANE MOUNTING FOAM GUN

- [BG] Пистолет за полиуретанова пяна • [RO] Pistol spuma poliuretanică • [EL] Πιστόλι αφρού μονταρίσματος • [PT] Pistola para espuma
- [IT] Pistola per schiuma di poliuretano • [SR] Pištolj za Pur Penu • [SL] Pištolica za montažno peno • [BH] • [RU] • [MK] Пиштол за Пур Пена

арт. № Баркод  
art. № Barcode

491308



FULL  
TEFLON  
COATED

## HEAVY DUTY CAULKING GUN

- [BG] Пистолет за силикон - усилен • [RO] Pistol pt tub silicon • [EL] Πιστολι Σιλικονησ • [PT] Hammer holster
- [IT] Custodia per martello • [SR] Pistolj za silicon • [SL] • [BH] • [RU] • [MK] Пиштол за силикон

арт. № Баркод  
art. № Barcode

492001



3000  
N

## CAULKING GUN

- [BG] Пистолет за силикон - усилен • [RO] Pistol pt tub silicon
- [EL] Πιστολι Σιλικονησ • [PT] Hammer holster • [IT] Custodia per martello
- [SR] Pistolj za silicon • [SL] • [BH] • [RU] • [MK] Пиштол за силикон

арт. № Баркод  
art. № Barcode

492002



NEW

1800  
N

## HAMMER HOLSTER

- [BG] Кобур за чук • [RO] Suport ciocan • [EL] Θήκη βαριοπούλας • [PT] Hammer holster • [IT] Custodia per martello • [SR] Futrola za čekić
- [SL] Torbica za kladivo • [BH] Držać čekića • [RU] Кобура для молоток • [MK] Футрола за чекан

арт. № Баркод  
art. № Barcode

499970



## TOOLS HOLSTER

- [BG] Кобур за инструменти с поставка за чук • [RO] Suport scule • [EL] Θήκη σφυρι • [PT] Tools holster with hammer space • [IT] Porta attrezzi
- [SR] Futrola za alat • [SL] Tok za orodje • [RU] кобура для инструментов • [MK] Футрола за алат

арт. № Баркод  
art. № Barcode

499971





## TOOL BAG

- [BG] Текстилна чанта за инструменти • [RO] Geanta scule • [EL] Τσάντα μαστόρων • [PT] Tool bag • [IT] Borsa degli attrezzi • [SR] Torba za alat
- [SL] Vreča za orodja • [RU] Мешка для инструментов • [MK] Торба за алатки

арт. № art. №	Размер / Size (mm)	Баркод Barcode
499944	330 x 180 x 190	



## TOOL BAG

- [BG] Текстилна чанта за инструменти • [RO] Geanta scule • [EL] Τσάντα μαστόρων • [PT] Tool bag • [IT] Borsa degli attrezzi
- [SR] Torba za alat • [SL] Vreča za orodja • [RU] Мешка для инструментов • [MK] Торба за алатки



арт. № art. №	Размер / Size (mm)	Макс натоварване / Max load	Обем / Capacity	Баркод Barcode
499948	400 x 230 x 310	25 kg	28.5 l	



## TOOL BAG WITH TWO ORGANIZERS

- [BG] Текстилна чанта за инструменти с органайзери • [RO] Geanta scule • [EL] Τσάντα μαστόρων • [PT] Tool bag • [IT] Borsa degli attrezzi
- [SR] Torba za alat • [SL] Vreča za orodja • [RU] Мешка для инструментов
- [MK] Торба за алатки

Размер органайзери / Size organizers:  
195 x 130 x 35 mm



арт. № art. №	Размер / Size (mm)	Макс натоварване / Max load	Обем / Capacity	Баркод Barcode
499947	420 x 200 x 240	22 kg	20 l	



## TOOL BAG

- [BG] Текстилна чанта за инструменти • [RO] Geanta scule • [EL] Τσάντα μαστόρων • [PT] Tool bag • [IT] Borsa degli attrezzi
- [SR] Torba za alat • [SL] Vreča za orodja • [RU] Мешка для инструментов • [MK] Торба за алатки



арт. № art. №	Размер / Size (mm)	Макс натоварване / Max load	Обем / Capacity	Баркод Barcode
499946	480 x 230 x 280	25	30 l	



# 10

*СПЕЦИАЛИЗИРАНИ АВТОИНСТРУМЕНТИ*  
*AUTOMOTIVE TOOLS & EQUIPMENT*

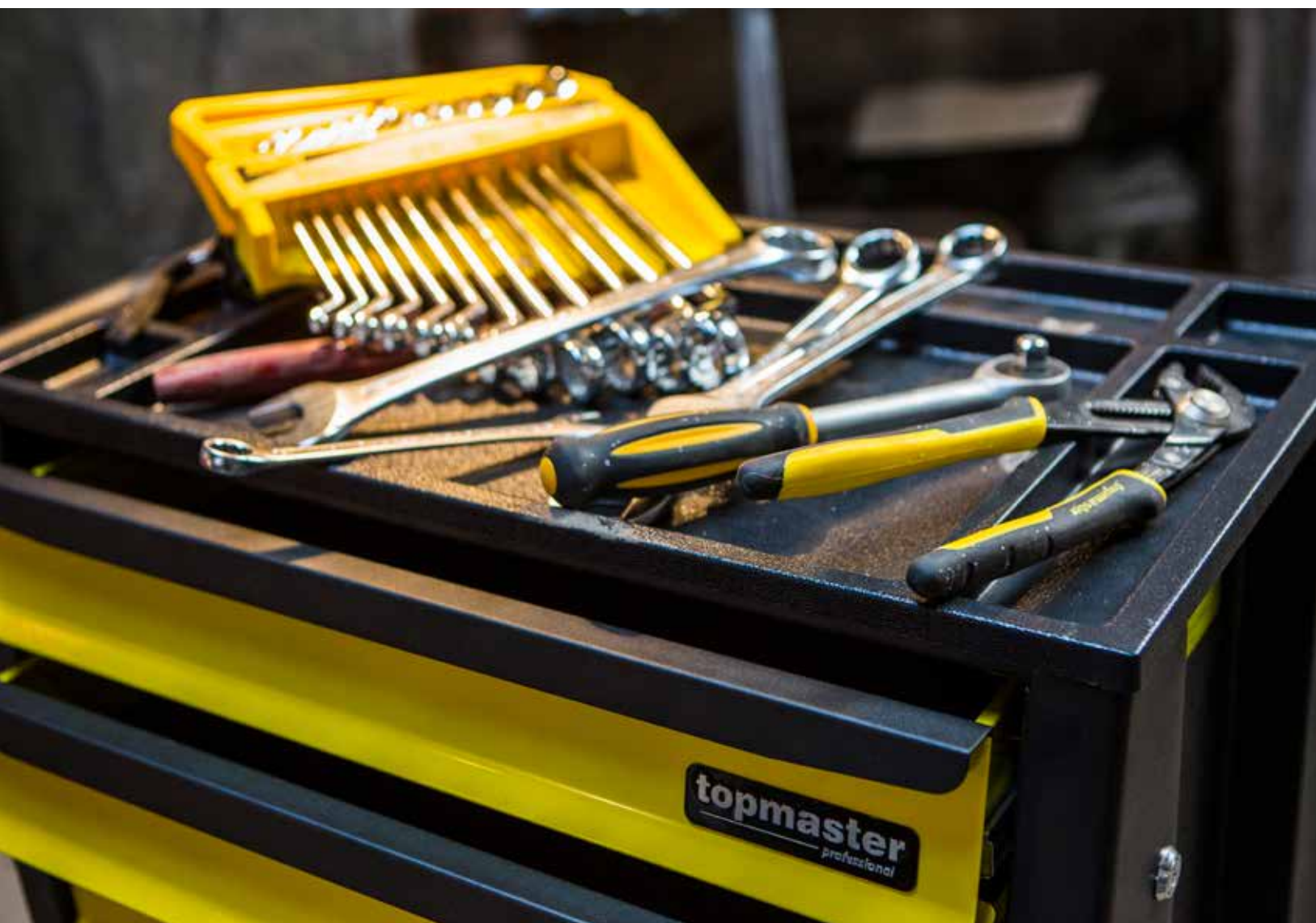

# 7 DRAWERS TOOL CABINET WITH 182 TOOLS

- [BG] Количка за инструменти с 7 чекмеджета и 182 инструмента • [RO] Dulap mobil pentru scule 7 sertare cu 182 de unelte
- [EL] Εργαλειοφόρέας 7 θέσεων με 182 εργαλεία • [PT] Gaveta de 7 gavetas com 182 ferramentas • [IT] 7 cassettiere per utensili con 182 strumenti • [SR] Kolica za alat sa 7 fioka prazna sa 182 alata • [SI] Omarica za orodja z 182 orodji • [BH] 7 ladica Ormarić za alat sa 182 alata
- [RU] Инструментальная Тележка С 7-ю Ящичками с 182 инструментами • [MK] Количка за алат со 182 алати

PP work stainless top with five compartments for small parts



Stainless handle for easy pushing, pulling and twisting

Side door storage room

Central locking with cylindrical lock

Drawer load capacity of 5 drawers up to 35  
2 drawers up to 45 kg

4 PVC + PP 5 x 1 1/4" caster fixed and swivel with brakes

Load capacity 550 kg

### FIFTH DRAWER

6 units Ballpoint T – handle hex keys - 2 x 100, 2.5 x 100, 3 x 100, 4 x 150, 5 x 150, 6 x 150 mm

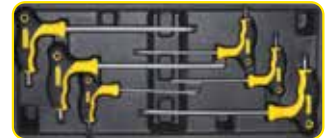

### FIRST DRAWER

13 units: Ratchet combination wrenches 8, 9, 10, 11, 12, 13, 14, 15, 16, 17, 19, 21, 22 mm (CR-V Steel)

9 units: Hex key wrenches 1.5, 2, 2.5, 3, 4, 5, 6, 8, 10 mm (CR-V Steel)

9 units: 1/4" deep sockets 4, 5, 6, 7, 8, 9, 10, 11, 12 mm (CR-V Steel)

23 units: 1/4" bit sockets T8, T10, T15, T20, T25, T30, T40, H3, H4, H5, H6, H7, H8, PH1, PH2, PH3, PZ1, PZ2, PZ3, SL3, SL4, SL5, SL6 (CR-V Steel)



### SECOND DRAWER

1 unit: Ratchet handle 1/2" 72T, 17 units: 1/2" 6 point sockets 10, 11, 12, 13, 14, 15, 16, 17, 18, 19, 21, 22, 23, 24, 27, 30, 32 mm

1 unit: 1/2" 125 mm extension bar

1 unit: 1/2" 250 mm extension bar

1 unit: 1/2" sliding T-bar

1 unit: 1/2" universal joint

1 unit: Ratchet handle 3/8" 72T, 15 units: 3/8" 6 point sockets 8, 9, 10, 11, 12, 13, 14, 15, 16, 17, 18, 19, 21, 22, 24 mm

1 unit: 3/8" universal joint

1 unit: 3/8" 75 mm extension bar

1 unit: 3/8" 236 mm extension bar

1 unit: 3/8" sliding T-bar

1 unit: Ratchet handle 1/4" 72T

1 unit: 1/4" Spinner handle extension bar

13 units: 1/4" 6 point sockets 4, 4.5, 5, 5.5, 6, 7, 8, 9, 10, 11, 12, 13, 14 mm

1 unit: 1/4 100 mm extension bar

1 unit: 1/4" sliding T-bar

1 unit: 1/4" universal joint

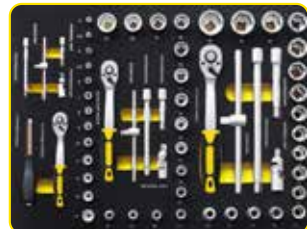

### THIRD DRAWER

6 units: screwdrivers (+)PH0x75 PH1x 100 PH2x38 PH2 x 100; PH2x150 PH3x200 mm

6 units: screwdrivers (-)6x38 3x75 4x100 5x100 6x150 8x200 mm

40 units bit set

7 units 30L HEX BIT: 4-5-6-7-8-10-12 mm

7 units 75L HEX BIT: 4-5-6-7-8-10-12 mm

5 units 30L SPLINE BIT: M5-M6-M8-M10-M12

5 units 75L SPLINE BIT: M5-M6-M8-M10-M12

7 units 30L TORX BIT: T20-T25-T30-T40-T45-T50-55

7 units 75L TORX BIT: T20-T25-T30-T40-T45-T50-55

2 units-BIT HOLDER: 1/2"Drx10mm&3/8"DRX10 mm

40 units bits included



### FOURTH DRAWER

4 units circlip pliers

Combination pliers – 200 mm

Long nose pliers – 200 mm

Cutting pliers – 180 mm

Locking pliers – 250 mm

Water pump pliers - 250 mm



арт. № Size Баркод  
art. № (mm) Barcode

455555 769x459x969



**X182** **5 TRAYS** **DOUBLE WALLS** **4 CASTERS** **7 DRAWERS** **BALL BEARING** **Cr-V STEEL**



# 7 DRAWERS TOOL CABINET SET

- [BG] Количка за инструменти 7 чекмеджета 220 части комплект • [RO] Dulap mobil pentru scule 7 sertare 220 piese
- [EL] Εργαλειοφορέας 7 θέσεων • [PT] Gaveta de 7 gavetas • [IT] 7 cassetteiere per utensili • [SR] Kolica za alat sa 7 fioka
- [SI] Omarica za orodja • [BH] 7 ladica Ormarić za alat • [RU] Инструментальная Тележка С 7-ю Ящиками • [MK] Количка за алат

## FIRST DRAWER

19 Units 1/4" Dr. Socket Set:

13-1/4" Dr. Socket 4-4.5-5-5.5-6-7-8-9-10-11-12-13-14mm;

- 1- 1/4" Dr. Universal Joint
- 1- 1/4" Dr. Sliding Bar
- 2- 1/4" Dr. Extension Bar. 50-100mm
- 1- 1/4" Dr. Ratchet Handle
- 1- 1/4" Spinner Handle

31 Units 3/8" Dr. Socket And Accessories

17- 3/8" Dr. Socket 6-7-8-9-10-11-12-13-14-15-16-17-18-19-20-21-22mm

- 1-3/8"DR. Universal Joint
- 1-3/8"DR. Sliding Bar
- 2-3/8"DR.75-150mm
- 2-3/8" Spark Plug Socket 16-21mm
- 1-3/8" Ratchet Handles
- 7- 3/8" Dr. E socket E10-11-12-14-16-18-20mm

22 Units 1/2" Dr. Socket Set:

17-1/2" Dr. Socket Set 10-11-12-13-14-15-16-17-18-19-21-22-23-24-27-30-32mm

- 1-1/2"DR. Universal Joint
- 1-1/2"DR. Sliding Bar
- 2-1/2"DR. Extension Bar. 125 - 250mm
- 1-1/2"DR. Ratchet Handles

## SECOND DRAWER

14 Units 1/2" Dr. Deep Socket Set

8 - 9 - 10 - 11 - 12 - 13 - 14 - 15 - 16 - 17 - 18 - 19 - 20 - 21 mm

17 Units Combination spanners 6 to 22mm 8 units Ring Wrenches: 6 - 7 mm, 8 - 9mm, 10 - 11 mm, 12 - 13 mm, 14 - 15 mm, 16 - 17 mm, 18 - 19 mm, 20 - 22 mm

## THIRD DRAWER

85 Units Socket and Bits Set:

- 33- 6 x 25mm Bits:
- SL: (4-6) x 2 Units PH: (1-2-3) x 2 Units
- PZ: (1-2-3) x 2 Units HEX: 4-5-6
- TORX: 10 - 15 - 20 - 25 - 27 - 30 - 40
- TORX WITH HOLE: 10 - 15 - 20 - 25 - 27 - 30 - 40; 18 - 10 x 30 mm
- Bits:
- HEX: 4 x 2 Units - 5 x 2 Units - 6 - 7 - 10
- TORX: 20-25-30-40-50-55; M:5 x 2 Units-6-8-10;
- 18-10 x 70 mm Bits HEX: 4 x 2 Units - 5 x 2 Units - 6 - 7 - 10
- TORX: 20-25-30-40-50-55, M:5 x 2 Unit S-6-8-10

- 5- 1/4" Dr. E socket 4-5-6-7-8 mm
- 7- 1/2" Dr. E socket 10-11-12-14-16-18-20 mm
- 2- ADA.; 1- Bits Holder ; 1- Quick Release Bit Holder

8 units PH Screwdrivers: SL6.0 x 38 mm, SL4 x 100 mm SL5.0 x 100 mm, SL6.0 x 150 mm, PH2 x 38 mm PH1 x 100 mm, PH2 x 100 mm, PH3 x 150 mm

7 units Torx Screwdrivers: T10 x 75 mm T15 x 75 mm T20 x 100 mm, T25 x 100 mm, T27 x 100 mm T30 x 125 mm, T40 x 150 mm

## FOURTH DRAWER

- 3 units Pliers: 1-Combination Pliers 8"
- 1-Diagonal Cutting Pliers 7.5"
- 1- Long Nose Pliers 8"
- 2 units Hammers: 1-Mechanic Hammer 500 g
- 1- Mallet 40 mm
- 1 Unit Storage tray

## FIFTH DRAWER

4 Units 24, 27, 30, 32 mm Combination spanners



арт. № art. №	Size (mm)	Баркод Barcode
464102	958 x 465 x 766	

X220
12 TRAYS
DOUBLE WALLS
4 CASTERS
7 DRAWERS
BALL BEARING
Cr-V STEEL
S2 STEEL



# 6 DRAWERS TOOL CABINET

- [BG] Количка за инструменти 6 чекмеджета • [RO] Dulap mobil pentru scule 6 sertare
- [EL] Εργαλειοφορέας 6 θέσεων • [PT] Gaveta de 6 gavetas • [IT] 6 cassettiere per utensili • [SR] Kolica za alat sa 6 fioka prazna
- [SI] Omarica za orodja • [BH] 6 ladica Ormarić za alat • [RU] Инструментальная Тележка С 6-ю Ящиками • [MK] Количка за алат



арт. № art. №	Size (mm)	Баркод Barcode
499997	1005 x 475 x 785	

## LOW PROFILE HYDRAULIC JACK TMP-HJ25

- [BG] Крик хидравличен тип нископрофилен • [RO] Cric tip crocodil • [EL] Γρύλος υδραυλικός • [PT] Jack tipo hidráulico crocodilo
- [IT] Martinetto idraulico tipo coccodrillo • [SR] Dizalica krokodil • [SL] Dvigalka hidravljična • [BH] Hidraulična dizalica
- [RU] Гидравлический Автомобильный Домкрат • [MK] Хидрулична дигалка



- ✓ The hydraulic technology makes lifting simple while a wider frame and an internal bypass valve ensure safety
- ✓ The safety bypass system prevents overloading and ensures safe operation.
- ✓ Steel casters for longevity
- ✓ Special quality design: the polished and treated cylinder rams use high performance seats
- ✓ Polished inner cylinder walls extend the life of the seals in order to minimize abrasion and wear off

### Бързоповдигаща двойна помпа Fast Lifting Dual Pump

Art. № Art. №	Диапазон Range (mm)	Товароносимост Load capacity (t)	Баркод Barcode
292202	80 - 515	2.5	

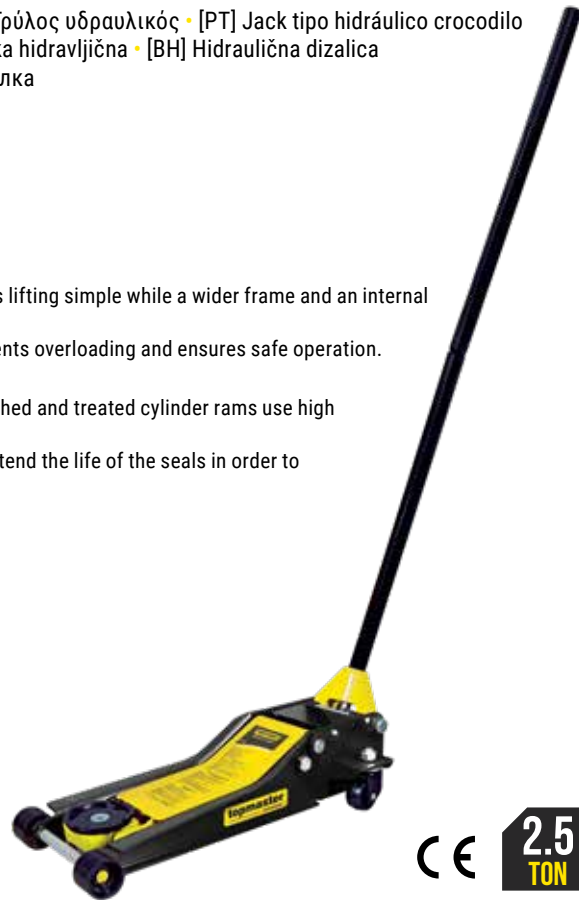

## HYDRAULIC JACK QUICK LIFT WITH FOOT PEDAL

- [BG] Крик хидравличен нископрофилен с 6 колела • [RO] Cric tip crocodil • [EL] Γρύλος υδραυλικός
- [PT] Jack tipo hidráulico crocodilo • [IT] Martinetto idraulico tipo coccodrillo • [SR] Dizalica krokodil
- [SL] Dvigalka hidravljična • [BH] Hidraulična dizalica • [RU] Гидравлический автомобильный домкрат
- [MK] Хидрулична дигалка



- Магнитна платформа
- Magnetic surface



- Педал за бързо повдигане
- Foot pedal for quick lifting

- ✓ The hydraulic technology makes lifting simple while a wider frame and an internal bypass valve ensure safety
- ✓ The safety bypass system prevents over-loading and ensures safe operation
- ✓ Polished inner cylinder walls extend the life of the seals in order to minimize abrasion and wear off
- ✓ Special quality design: the polished and treated cylinder rams use high performance seats
- ✓ All steel wheels + PU polymer coated front wheels

Art. № Art. №	Диапазон Range (mm)	Товароносимост Load capacity (t)	Баркод Barcode
292201	70 - 500	2	



## ADJUSTABLE FILTER WRENCH

- [BG] Ключ за маслен филтър тип "паяк" • [RO] Cheie reglabila pentru filtru ulei • [EL] Κλειδί φίλτρου λαδιού • [PT] Chave de filtro ajustável
- [IT] Chiave per filtri regolabile • [SR] Ključ za filter za ulje • [SL] Ključ za filter za ulje šteljuči • [BH] Podesivi ključ za filter
- [RU] Регулируемый Ключ Для Масленного Фильтра • [MK] Прилагодлив ключ за филтер за масло, трокрак



Art. № Size Баркод  
Art. № (mm) Barcode

331004 80 - 130



## ADJUSTABLE FILTER WRENCH

- [BG] Ключ за маслен филтър тип "паяк" • [RO] Cheie reglabila pentru filtru ulei • [EL] Κλειδί φίλτρου λαδιού • [PT] Chave de filtro ajustável
- [IT] Chiave per filtri regolabile • [SR] Ključ za filter za ulje • [SL] Ključ za oljni filter • [BH] Podesivi ključ za filter
- [RU] Регулируемый Ключ Для Масленного Фильтра • [MK] Прилагодлив ключ за филтер за масло



Art. № Size Баркод  
Art. № (mm) Barcode

331003 74 - 95



## OIL FILTER WRENCH

- [BG] Клещи за маслен филтър • [RO] Cleste filtru ulei • [EL] Κλειδί φίλτρου λαδιού • [PT] Chave do filtro de óleo
- [IT] Chiave per filtro dell'olio • [SR] Ključ za filter za ulje • [SL] Ključ za oljni filter • [BH] Ključ za ulje filtera
- [RU] Плоскогубцы Для Масляного Фильтра • [MK] Клещи за филтер за масло



Art. № L Opening Баркод  
Art. № (mm) capacity (mm) Barcode

343603 290 63 - 108



## UNIVERSAL TIE ROD WRENCH

- [BG] Ключ за вътрешни крайници • [RO] Cheie bieleta directie • [EL] Εξωκέας ημίπαρων • [PT] Chave de tirante universal
- [IT] Chiave universale per tirante • [SR] Univerzalni ključ za ključeve • [SL] Univerzalni ključ • [BH] Univerzalni ključ za ključeve
- [RU] Ключ Для Внутренних Наконечников • [MK] Универзален ключ



Art. № Size Баркод  
Art. № (mm) Barcode

342805 27 - 42



## OIL SERIES SOCKET TOOLS SET

- [BG] Ключове за картер комплект • [RO] Set chei pentru buson ulei • [EL] Σετ κλειδιά για αφαίρεση λαδιών
- [PT] Conjunto de ferramentas de soquete de série de óleo • [IT] Set di chiavi a bussola serie olio • [SR] Ključ nasadni za filter ulja
- [SL] Garnitura za nasadne ključe • [BH] Set alata za ulje serije • [RU] Набор Ключей Для Картера
- [MK] Гарнитура насадни клучеви за завртка за масло на кардан



Art. № Баркод  
Art. № Barcode

339601



- Suitable for sump plugs on engine, gearbox and Back Axle
- 8 mm: HEX BMW (Back Axle), FORD (Gear Box) GM (Back Axle, Gear Box)
- 9 mm: HEX General Motors (Back Axle)
- 10 mm: HEX FORD (Back Axle)
- 12 mm: HEX FIAT LANCIA (Gear Box, Pump), PEUGEOT TALBOT (Gear Box, Pump)
- 14 mm: HEX LANCIA (Gear Box, Pump), MERCEDES (Back Axle, Gear Box)
- 17 mm: HEX AUDI (Gear Box), AUSTIN (GM), BMW (Gear Box), VW (Gear Box)
- 3/8 HEX BLMC (MORRIS) (Back Axle), LANCIA BETA (DIFF)
- 8 mm: (5 / 6) SQ CITROEN (Gear Box, Pump), PEUGEOT (Back Axle, Gear Box, Pump) RENAULT (Pump), TALBOT (Gear Box, Pump), VOLVO (Pump)
- 13 mm: SQ NISSAN (Back Axle, Gear Box), SUBBack AxleRU (Back Axle)
- 3/8 SQ HONDA (Gear Box, Pump), MAZDA (Back Axle, Gear Box), RENAULT (Gear Box, Pump) SAAB (Gear Box), VOLVO (Back Axle, Pump)



## ALL PURPOSE GEAR PULLER

- [BG] Скоба за лагери многофункционална • [RO] Extractor elicoidal • [EL] Εξωκέντρος πολλαπλών χρήσεων • [PT] Extrator de engrenagens
- [IT] Estrattore multiplo • [SR] Radarpciger • [SL] Snemalec jermenic • [BH] Zupčasti rogon • [RU] Съемник подшипников
- [MK] Извлекувач со три краца

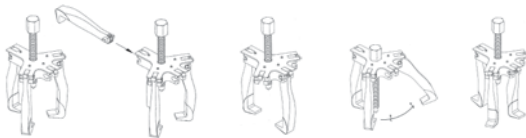

арт. № art. №	Max size (mm)	L (mm)	L1 (mm)	L2 (mm)	L3 (mm)	Capacity (t)	Баркод Barcode
343601	80	90	15	65	124	2	
343602	140	133	20	96.4	209	5	

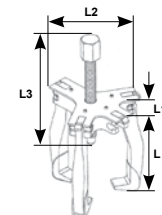

## SCREW EXTRACTOR SET

- [BG] Екстрактори комплект • [RO] Set extractoare suruburi • [EL] Εξωκέντρος βίδας σετ • [PT] Removedor de parafusos • [IT] Set di estrattori a vite
- [SR] Set za vađenje polomljenih vijaka • [SL] za odvijanje vijakov • [BH] Set vijaka • [RU] Набор Экстракторов • [MK] Сет екстрактори

Art. № Art. №	Ø (mm)	L (mm)	Баркод Barcode
499928	3-6	52	
	6-8	58	
	8-11	66	
	11-14	75	
	14-18	80	

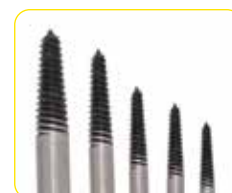



## SCREW EXTRACTOR SET

- [BG] Екстрактори комплект • [RO] Set extractoare suruburi • [EL] Εξωλκείας βίδας σετ • [PT] Removedor de parafusos • [IT] Set di estrattori a vite
- [SR] Set za vađenje polomljenih vijaka • [SL] za odvijačenje vijakov • [BH] Set vijaka • [RU] Набор Экстракторов • [MK] Сет екстрактори

Content:

- 1# works for screws in 3-5mm
- 2# works for screws in 4-8mm
- 3# works for screws in 5-10mm
- 4# works for screws in 6-12mm

Арт. № Баркод  
Art. № Barcode

339701



X4

CR-Mo  
STEEL

## SCREW EXTRACTOR

- [BG] Екстрактор за шпилка • [RO] Extractor suruburi • [EL] Εξωλκείας βίδα • [PT] Extrator de parafuso • [IT] Vite estrattore
- [SR] Izvlakač za vijke • [SL] Snemalec zatičev • [BH] Ekstraktor vijaka • [RU] Экстрактор • [MK] Экстрактор

Арт. № Капацитет Баркод  
Art. № Capacity (mm) Barcode

330412

6 - 19



1/2"

CR-Mo  
STEEL

Cr-V  
STEEL

## BEARING SPLITTER

- [BG] Сепаратор за лагери • [RO] Extractor rulmenti • [EL] Εξωλκείας & διαχωριστής ρουλεμάν • [PT] Extrator de rolamentos
- [IT] Cuscinetto extractor • [SR] Stega za ležajeve • [SL] Ležaj • [BH] Nosač split • [RU] Сепаратор • [MK] Склоп за сепаратор

Арт. № Капацитет Баркод  
Art. № Capacity (mm) Barcode

342806

50 - 30



342807

75 - 50



342808

75 - 105



Cr-V  
STEEL

## BEARING SPLITTER SET

- [BG] Сепаратор за лагери комплект • [RO] Set extractoare rulmenti • [EL] Εξωλκέας & διαχωριστής ρουλεμάν • [PT] Extrator de rolamentos
- [IT] Cuscinetto splitter • [SR] Separator kampovi • [SL] Nosilec cepilnika • [BH] Podesiva sklopka • [RU] Набор Съёмников Сепараторного Типа
- [MK] Гарнитура склопови за сепр



Art. №      Баркод  
Art. №      Barcode

342810



## BALL JOINT PULLER

- [BG] Скоба за ябълковидни болтове • [RO] Extractor pivoti • [EL] Σφουκτήρας ελατηρίου αμορτισέρ
- [PT] Alavanca para cravar espições • [IT] Pressa rimozione cuscinetto a sfera sterzo • [SR] Radapciger • [SL] Snemalec
- [BH] Pričvrtni vijak • [RU] Съёмник Шаровых Опор • [MK] Извлекувач на округли спојки

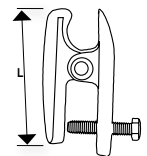

Art. №      Jaw      Ø      L      Баркод  
Art. №      (mm)      (mm)      (mm)      Barcode

332211

19

17.5

135



## BALL JOINT PULLER

- [BG] Скоба за ябълковидни болтове • [RO] Extractor pivoti • [EL] Σφουκτήρας ελατηρίου αμορτισέρ
- [PT] Alavanca para cravar espições • [IT] Pressa rimozione cuscinetto a sfera sterzo • [SR] Radapciger • [SL] Snemalec
- [BH] Pričvrtni vijak • [RU] Съёмник Шаровых Опор • [MK] Извлекувач на округли спојки

- Special design 2-stage operating
- Offset lever permits maximum jaw permit 30 mm & 56 mm



Art. №      (mm)      Barcode

342802

22



## BALL JOINT PULLER

- [BG] Скоба за ябълковидни болтове • [RO] Extractor pivoti • [EL] Σφικτήρας ελατηρίου αμορτισέρ
- [PT] Alavanca para cravar espigões • [IT] Pressa rimozione cuscinetto a sfera sterzo • [SR] Radapciger • [SL] Snemalec • [BH] Pričvrtni vijak
- [RU] Съёмник Шаровых Опор • [MK] Извлекувач на округли спојки

Art. № Art. №	Jaw open (mm)	Jaw deep (mm)	Баркод Barcode
332210	23	25	



## BALL JOINT PULLER



- [BG] Скоба за ябълковидни болтове • [RO] Extractor pivoti • [EL] Σφικτήρας ελατηρίου αμορτισέρ
- [PT] Alavanca para cravar espigões • [IT] Pressa rimozione cuscinetto a sfera sterzo • [SR] Radapciger • [SL] Snemalec
- [BH] Pričvrtni vijak • [RU] Съёмник Шаровых Опор • [MK] Извлекувач на округли спојки

Art. № Art. №	Jaw (mm)	Баркод Barcode
342809	20	



## TIE ROD FORK

- [BG] Вилка за шарнири • [RO] Furca pivoti • [EL] Εξωλκείας ακρόμπαρων-Πιρούνα • [PT] Garfo de tirante • [IT] Forcella tirante
- [SR] Poluga za zglobove • [SL] Vilice za zglobe • [BH] Viljuska vilica • [RU] Съёмник Шаровых Опор Тип Вилка
- [MK] Извлекувач за зглобови

арт. № art. №	L (mm)	L <sub>1</sub> (mm)	L <sub>2</sub> (mm)	Баркод Barcode
332202	300	24	80	
332201	400	18	70	

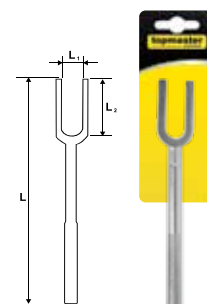

## VALVE SPRING COMPRESSOR

- [BG] Скоба за клапани • [RO] Presa pentru arcuri supare • [EL] Εξωλκείας ελατηρίων βαλβιδών • [PT] Compressor de Mola de Válvula
- [IT] Compresore a molle valvole • [SR] Klešta za ventile • [SL] Kompresor valjaste vzmeti • [BH] Klapna ventila
- [RU] Скоба Для Клапанов • [MK] Вентил менгеме



Art. № Art. №	Size (mm)	Баркод Barcode
342803	320	



## CROW BAR

- [BG] Щанга • [RO] Levier din otel • [EL] Λοστός • [PT] Pé de cabra • [IT] Barra di corvo • [SR] Poluga • [SL] Izvič cromiran
- [BH] Gvozdena poluga • [RU] Монтировочная Лопатка • [MK] Штангла



Art. № Art. №	L (mm)	Баркод Barcode
221593	600	



## CROW BAR SET

- [BG] Щанги комплект • [RO] Set rangi • [EL] Λοστός σετ • [PT] Pé de cabra set • [IT] Barra di corvo set • [SR] Set poluga
- [SL] Set izvijačev • [BH] Gvozdena poluga set • [RU] Набор Монтировочных Лопаток • [MK] Сет штангли



Art. № Art. №	L (mm)	Баркод Barcode
223902	200, 300, 450, 600	





## PUNCH & CHISEL SET

- [BG] Пробои и секачи комплект • [RO] Trusa dalti si dornuri • [EL] Ζουμπάδες, Πόντες, Κοπίδια σετ • [PT] conjunto de punção e cinzel
- [IT] Set di punch e scalpello • [SR] Sekači i probijači • [SL] Garnitura sekačev • [BH] punch & dits set • [RU] Набор Надфилей
- [MK] Гарнитура секачи и пробивачи



3 PC COLD CHISEL:

- 3/8X5/16X5-1/2 (9.5 x 8 x 140 mm)
- 1/2 x 7/16 x 6 (12.7 x 11 x 152 mm)
- 5/8 x 15/32 x 6-1/2 (15.8 x 12 x 165 mm)

2 PC CENTER PUNCH:

- 1/8X5/16X5:3.2X8X127 mm
- 3/16X7/16X6:4.8X11X152 mm

5 PC PIN PUNCH:

- 3/32 x 1/4 x 4-1/4:2.4 x 6.3 x 108 mm
- 1/8 x 5/16 x 4-3/4:3.2 x 8 x 120 mm
- 5/32 x 3/8 x 5-4 x 9.5 x 127 mm
- 3/16 x 3/8 x 5-1/4:4.8 x 9.5 x 133 mm
- 1/4 x 7/16 x 5-3/4:6.3 x 11 x 146 mm

5 PC TAPER PUNCH:

- 3/32 x 5/16 x 5-1/4:2.4 x 8 x 133 mm
- 1/8 x 3/8 x 5-3/4:3.2 x 9.5 x 146 mm
- 5/32 x 3/8 x 6-4 x 9.5 x 152 mm
- 3/16 x 7/16 x 6-1/4:4.8 x 11 x 159 mm
- 1/4 x 7/16 x 6-3/4:6.3 x 11 x 171 mm



Art. № Баркод  
Art. № Barcode

499921 



## PUNCH & CHISEL SET

- [BG] Пробои и секачи комплект • [RO] Trusa dalti si dornuri • [EL] Ζουμπάδες, Πόντες, Κοπίδια σετ • [PT] conjunto de punção e cinzel
- [IT] Set di punch e scalpello • [SR] Sekači i probijači • [SL] Garnitura sekačev • [BH] punch & dits set • [RU] Набор Надфилей
- [MK] Гарнитура секачи и пробивачи



Name	Size (mm)
Cold Chisel	12*9.5*130
Cape Chisel	5*9*130
Pin Punch	4*9.5*150
Center Punch	4*9.5*120
Taper Punch	3*9.5*120



Art. № Баркод  
Art. № Barcode

499998 



## UNIVERSAL WIPER ARM PULLER

- [BG] Скоба за демонтиране на рамена на чистачки • [RO] Extractor brat stergator parbriz
- [EL] Εξωλέκας μπράτσου υαλοκαθαριστήρων • [PT] Limpador • [IT] Clieste coliere cu extensie • [SR] Alat za skidanje brisača
- [SL] Snemalec zadnjih brisalcev • [RU] Универсальный Съёмник Стеклоочистительных Рычагов
- [MK] Извлекаувач на заден брисач на ветробранско стакло



Art. № Баркод  
Art. № Barcode

348100 



## UNIVERSAL WIPER ARM PULLER

- [BG] Скоба за демонтиране на рамена на чистачки • [RO] Extractor brat stergator parbriz
- [EL] Εξωλεκέας μπράτσου υαλοκαθαριστήρων • [PT] Limpador • [IT] Cleste coliere cu extensie • [SR] Alat za skidanje brisača
- [SL] Snemavec zadnjih brisalcev • [RU] Универсальный Съёмник Стеклоочистительных Рычагов
- [MK] Извлекаувач на заден брисач на ветробранско стакло

Арт. № Art. №	Баркод Barcode
348101	



## UNIVERSAL WIPER ARM PULLER

- [BG] Скоба за демонтиране на рамена на чистачки • [RO] Extractor brat stergator parbriz
- [EL] Εξωλεκέας μπράτσου υαλοκαθαριστήρων • [PT] Limpador • [IT] Cleste coliere cu extensie • [SR] Alat za skidanje brisača
- [SL] Snemavec zadnjih brisalcev • [RU] Универсальный Съёмник Стеклоочистительных Рычагов
- [MK] Извлекаувач на заден брисач на ветробранско стакло

Арт. № Art. №	Jaw (mm)	Баркод Barcode
348102	10 - 30	



## FLEXIBLE LINE CLAMP SET

- [BG] Клещи пристягащи за маркучи комплект • [RO] Set clesti pentru furtun auto • [EL] Σετ Σφιγκτήρες ελαστικών σωλήνων
- [PT] Grampo vincador de mangueira • [IT] Set per tubo flessibile auto • [SR] Plastična klešta set • [SL] Plastične kleščice za preščip cevi
- [BH] Obujmice za crevo • [RU] Комплект Зажимов Для Шлангов • [MK] Пластична клешта

Арт. № Art. №	Размер / Size (mm)	Баркод Barcode
213200	6.3 - 57	



- For brake and fuels line:  
1/4" - 3/4"  
6.3 - 19 mm
- Faor flexible hoses:  
1/2" - 5/4"  
12.5 - 32 mm
- For radiator hose clamp:  
3/4" - 9/4"  
19 - 57 mm



## PLIERS FOR BAND CLIP WITH MEMORY CORD

- [BG] Клещи за скоби за водни съединения с мемори жило
- [RO] Cleste coliere cu extensie
- [EL] Εύκαμπτος σφιγκτήρας ελαστικών σωλήνων
- [PT] Alicates de alça de mangueira
- [IT] Pinza per fascette stringitubo
- [SR] Klešta za šelne sa savitljivim kablom
- [SL] Kleščice za objemke
- [BH] Klijesta za objumice sa memorijskim kablom
- [RU] Гибкие Клещи Для Самозажимных Хомутов
- [MK] Клещи за стеги со флексибилен кабел



Арт. № Art. №	Челюсти (mm)	Баркод Barcode
343607	18 - 54	



## PLIERS FOR BAND CLIP WITH CORD

- [BG] Клещи за скоби за водни съединения
- [RO] Cleste coliere cu extensie
- [EL] Πένσα σφιγκτήρα κολάρου
- [PT] Alicates de alça de mangueira
- [IT] Pinza per fascette stringitubo
- [SR] Klešta za šelne sa savitljivim kablom
- [SL] Kleščice zobjemke s zavito žico
- [BH] Klijesta za objumice sa memorijskim kablom
- [RU] Шнурные Клещи Для Самозажимных Хомутов
- [MK] Клещи за стеги со флексибилно



Арт. № Art. №	Челюсти (mm)	Баркод Barcode
343600	18 - 54	



## COIL SPRING COMPRESSOR

- [BG] Скоби за макферсон
- [RO] Presa arcuri
- [EL] Εξωλκείας ελατηρίων αμορτισέρ
- [PT] Compressor de molas
- [IT] Kit Compressore molla elicoidale
- [SR] Stega za oprugu
- [SL] Izvlekači za vzmeti
- [BH] Kompresor opruge
- [RU] Приспособление Для Макферсона
- [MK] Стеги за пружини

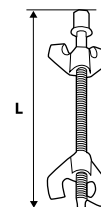

Арт. № Art. №	L (mm)	Баркод Barcode
342801	370	



## HOSE CLAMP PLIERS

- [BG] Клещи за скоби за водни съединения • [RO] Cleste strangere coliere furtun
- [EL] Πένσα Σφικτήρων • [PT] Alicates de alça de mangueira • [IT] Pinza per fascette stringitubo
- [SR] Klešta za šelne • [SL] Kleščice za objemke • [RU] Изогнутые Клещи Для Самозажимных Хомутов • [MK] Клешти за стеги



Арт. №      Баркод  
Art. №      Barcode

343606



## PLIERS FOR BAND CLIP

- [BG] Клещи за скоби за водни съединения • [RO] Cleste strangere coliere furtun
- [EL] Λοξή πένσα για κολάρα ψυγείων • [PT] Alicates de alça de mangueira • [IT] Pinza per fascette
- [SR] Klešta za šelne • [SL] Kleščice za objemke • [RU] Изогнутые Клещи Для Самозажимных Хомутов
- [MK] Клешти за стеги



Арт. №      Баркод  
Art. №      Barcode

343605



## VALVE STEAM SEAL RING PLIERS

- [BG] Клещи за гумички на клапани • [RO] Presa simering supape • [EL] Πένσα αφαίρεσης για τσιμουχάκια βαλβίδων
- [PT] Válvula stem seal anel alicates • [IT] Pinze per anelli di tenuta dello stelo della valvola • [SR] Klešta za ventile
- [SL] Kleščice za ventile • [RU] Клещи Для Клапанных Сальников • [MK] Клешти за вентили



Арт. №      Размер      Баркод  
Art. №      Size (mm)      Barcode

342804

250





## SPARK PLUG PLIERS

- [BG] Клещи многофункционални за стягане удължени • [RO] Cleste lung pentru fise bujii • [EL] Πένσα εξαγωγής μπουζοκαλωδίων
- [PT] Alicates para velas de ignição • [IT] Pinze per candele • [SR] Klešta za svećice • [SL] Kleščice za svečke
- [BH] Klešta za svećice • [RU] Клещи Для Свечей Зажигания • [MK] Клешти за свеќички

Art. № Art. №	L (mm)	Баркод Barcode
343604	280	



## BRAKE WIND - BACK TOOL SET

- [BG] К-т за сваляне на спирачни цилиндри с ляво и дясно въртене • [RO] Set reparatie etrier frana • [EL] Σετ περιστροφής εμβόλων φρένων
- [PT] Conjunto de ferramentas para recolha de êmbolos de travões • [IT] Set di attrezzi antivento freno • [SR] Alat za kočnice set
- [SL] Set za stiskanje zavornega cilindra • [BH] Kočioni vetar - Set alata za nazad • [RU] Комплект Для Обслуживания Тормозных Цилиндров
- [MK] Гарнитура за сопирачки сет

Art. № Art. №	Баркод Barcode
348200	



### Suitable for:

- Citroen/XM, Xantia (FR)
- Audi (F)
- Fiat / Alpha Romeo (F)
- Ford / Fiesta (F)
- Isuzu (F)
- Honda / Concesto (F)
- Jaguar / (XJ40 (FR))
- BMW / (318s, 320i, 325TD, 518i, 525i, 740i, 850ci, M5 (F))
- Mercedes Benz / (190, 200, 300, 420, 560 (F))
- Mitsubishi / Colt (F)
- Nissan / Almera, Sunny (F)
- Rover / (Austin, Metro, 200 & 400, Maestra, Montego (F))
- Toyota / Camry (F)
- Volvo (F)
- VW / (Passat, Golf GTI (F))



## 4 WAY WHEEL NUT WRENCH

- [BG] Ключ кръстат • [RO] Cheie cruce roti • [EL] Σταυρός αυτοκινήτου • [PT] Chave de rodas em cruz • [IT] Chiave a croce
- [SR] Ključ za točkove krstasti • [SL] Ključ za avtomobiliska kolesa • [BH] Noseći ključ sa 4 točka na točkovima
- [RU] Балонный Крестовой Ключ • [MK] Ключ за тркала

арт. № art. №	Размер Size W (mm)	L (mm)	Баркод Barcode
330319	17, 19, 21, 22, 1/2"	355	

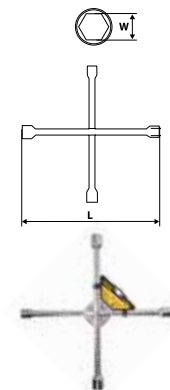

## TORQUE WRENCH

- [BG] Ключ динамометричен • [RO] Cheie dinamometrică • [EL] Δυναμόκλειδο • [PT] Chave dinamométrica
- [IT] Chiave dinamometrica a cricchetto • [SR] Moment ključ • [SL] Moment ključ • [BH] Momentni ključ • [RU] Динамометрический Ключ
- [MK] Клуч за вртежен момент



арт. № art. №	Размер Size	Nm	Баркод Barcode
331001	1/2"	41-210	 31800125146091



## TORQUE WRENCH

- [BG] Ключ динамометричен • [RO] Cheie dinamometrică • [EL] Δυναμόκλειδο • [PT] Chave dinamométrica
- [IT] Chiave dinamometrica a cricchetto • [SR] Moment ključ • [SL] Moment ključ • [BH] Momentni ključ • [RU] Динамометрический Ключ
- [MK] Клуч за вртежен момент



арт. № art. №	Размер Size	Nm	Баркод Barcode
331000	1/2"	28-210	 318009724004849



## LED LIGHTED FLEXIBLE INSPECTION MIRROR

- [BG] Огледало контролно с лампа • [RO] Oglinda inspectie cu LED • [EL] Καθρέπτης τηλεσκοπικός εύκαμπτος με φώς
- [PT] Espelho para inspeções • [IT] Specchio di ispezione • [SR] Ogledalo za inspekciju FLEX • [SL] Kontrolno ogledalo
- [BH] Led osvetljenje fleksibilnog ogledala • [RU] Контрольное Зеркало С Лампой • [MK] Контролно огледало со светилка

Арт. № Art. №	L (mm)	Баркод Barcode
339909	430	



## TELESCOPIC MAGNETIC PICK UP TOOL

- [BG] Магнит телескопичен • [RO] Tijă magnetica telescopică • [EL] Μαγνητικό αρπάγη
- [PT] Vareta extensível com ponta magnética • [IT] Penna magnetica telescopica • [SR] Magnetni hvatač teleskopski
- [SL] Magnetni pobiralec • [BH] Teleskopska magnetna alatka za pick-up
- [RU] Телескопический Магнитный Сборщик Гвоздей И Болтов • [MK] Телескопски магнет

Арт. № Art. №	L (mm)	Баркод Barcode
339908	130 - 700	



## TELESCOPIC MAGNETIC LED PICK UP TOOL

- [BG] Магнит телескопичен с лампа • [RO] Tijă magnetica telescopică cu LED • [EL] Μαγνητική αρπάγη με φώς
- [PT] • [IT] Barra magnetica telescopica • [SR] Magnetni hvatač teleskopski sa lampom • [SL] Magnetni pobiralec
- [BH] Teleskopska magnetna alatka za pick-up LED • [RU] Телескопический LED Магнитный Собиратель
- [MK] Телескопски магнет

Арт. № Art. №	L (mm)	Баркод Barcode
339926	190 - 800	



## TELESCOPIC MAGNETIC PICK UP TOOL

- [BG] Магнит телескопичен • [RO] Tijă magnetica telescopică • [EL] Μαγνητικό αρπάγη • [PT] Vareta extensível com ponta magnética
- [IT] Penna magnetica telescopica • [SR] Magnetni hvatač teleskopski • [SL] Magnetni pobiralec
- [BH] Teleskopska magnetna alatka za pick-up • [RU] Телескопический Магнитный Собиратель • [MK] Телескопски магнет

Арт. № Art. №	L (mm)	Баркод Barcode
342902	170 - 600	



## FLEXIBLE MAGNETIC PICK UP TOOL

- [BG] Магнит гъвкав • [RO] Tijă magnetică flexibilă • [EL] Μαγνητική αρπάγη • [PT] Flexível ponta magnética
- [IT] Penna magnetica telescopica • [SR] Fleksibilan-Magnet • [SL] Magnetni pobiralec • [BH] Fleksibilan alat za magnetni pick up
- [RU] Гибкий Телескопический Магнитный Собиратель • [MK] Флексибилен магнет



Art. № Art. №	L (mm)	Баркод Barcode
342903	500	



## MAGNETIC TOOL HOLDER

- [BG] Магнитен държач за инструменти • [RO] Bară magnetică pentru scule • [EL] Μαγνητική ράβδος στήριξης εργαλείων
- [PT] Barra de ferramentas magnética • [IT] Porta Utensili magnetico • [SR] Magnetni nosač alata • [SL] Magnetno držalo
- [BH] Magnetni nosač alata • [RU] Магнитный Держатель Для Инструментов • [MK] Магнетна шина за алатки



Art. № Art. №	L (mm)	Баркод Barcode
342900	500	



## MAGNETIC STAINLESS STEEL PARTS TRAY

- [BG] Чиния магнитна • [RO] Tava magnetică • [EL] Μαγνητικός δίσκος • [PT] Suporte magnético para soldadura
- [IT] Vassoio magnetico per accessori • [SR] Magnetna činija • [SL] Magnetna posoda • [BH] Magnetni delovi od nehrđajućeg čelika
- [RU] Стальная Магнитная Тарелка • [MK] Магнетна чинија



Art. № Art. №	Ø (mm)	Баркод Barcode
499973	100	
499974	150	



## MAGNETIC STAINLESS STEEL PARTS TRAY

- [BG] Чиния магнитна • [RO] Tava magnetică • [EL] Μαγνητικός δίσκος • [PT] Suporte magnético para soldadura
- [IT] Vassoio magnetico per accessori • [SR] Magnetna činija • [SL] Magnetna posoda • [BH] Magnetni delovi od nehrđajućeg čelika
- [RU] Стальная Магнитная Тарелка • [MK] Магнетна чинија



Art. № Art. №	Ø (mm)	Баркод Barcode
342904	65 x 150 x 17	
342905	237 x 136 x 28	





## MAGNETIC PARTS TRAY

- [BG] Чиния магнитна • [RO] Tava magnetica • [EL] Μαγνητικός δίσκος • [PT] Suporte magnético para soldadura
- [IT] Vassoio magnetico per accessori • [SR] Magnetna činija • [SL] Magnetna posoda • [BH] Magnetni delovi od nehrđajućeg čelika
- [RU] Магнитная Тарелка • [MK] Магнетна чинија

Art. № Art. №	Ø (mm)	Баркод Barcode
342700	150	



## FLUID DRAIN PAN

- [BG] Вана за масло • [RO] Cuvă recuperare fluide auto • [EL] Δοχείο λαδιών • [PT] Bandeja de drenagem de fluido
- [IT] Vaschetta di scarico del fluido • [SR] Posuda za tečnost • [SL] Posoda za tekočine • [BH] Fluidni odvodni kanal
- [RU] Ванна Для Масла • [MK] Сад за масло

Art. № Art. №	Вместимость Capacity (L)	Баркод Barcode
339602	7	



## CREEPER

- [BG] Авто - лежанка • [RO] Pat mobil pentru atelier • [EL] Ξαπλώστρα συνεργείου • [PT] Creeper dobrável • [IT] Creeper
- [SR] Ležaljka tarasirana mehaničarska • [SL] Delavniški ležalnik • [BH] Preklorivi kremator • [RU] Лежанка рабочая
- [MK] Механичарска лежалка

арт. № art. №	Width (mm)	Length (mm)	Баркод Barcode
348001	475	1010	



## FOLDBABLE CREEPER / SEAT

- [BG] Авто - лежанка стол • [RO] Pat mobil pentru atelier • [EL] Ξαπλώστρα συνεργείου • [PT] Creeper dobrável / assento
- [IT] Creeper / sedile pieghevole • [SR] Ležaljka tapacirana mehaničarska • [SL] Delavniški ležalnik • [BH] Preklopivi kremator / sjedište
- [RU] Лежак - Сиденье • [MK] Механичарска лежалка

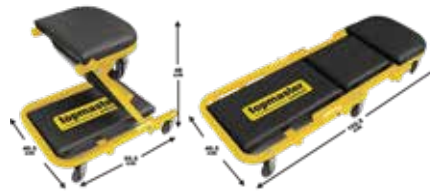

арт. № art. №	Width (cm)	Length (cm)	High (cm)	Баркод Barcode
348000	40.5	102.5	16	



## BATTERY CLEANING BRUSH

- [BG] Четка за почистване на клеми • [RO] Perie pentru curatat borne acumulator • [EL] Συρματόβουρτσα πόλων μπαταρίας
- [PT] Limpeza de terminais de baterias • [IT] Perie pt curatat borne acumulator auto • [SR] Četka za čišćenje kleva na akumulatorima
- [SL] Žična krtača • [BH] Četkica za čišćenje baterije • [RU] Щетка Для Полюсных Выводов Аккумулятора
- [MK] Четка за чистење на клеми на акумулатор

арт. № art. №	Ø1 mm	Ø2 mm	Ø3 mm	Баркод Barcode
348300	18 max	40	20	

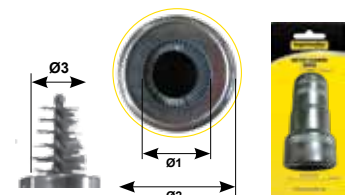

## RATCHET TAP WRENCH AUTOMATIC

- [BG] Върток за метчик автоматичен • [RO] Port-tarod • [EL] Κολαουζιέρα καστώνια • [PT] Mini chave reversível • [IT] Port-tarod
- [SR] Nosač ureznica • [SL] Ročaj za vrezovat navoje • [RU] Вороток Для Метчика • [MK] Одвртвач рачен за навртки

арт. № art. №	Размер Size	Баркод Barcode
490902	M3-M8	
490903	M5-M12	



## AUTOMOTIVE VOLT TESTER

- [BG] Автотестер • [RO] Tester tensiune • [EL] Κατσαβίδι δοκιμαστικό αυτοκινήτου με ακροδέκτη
- [PT] Busca polos metálico • [IT] Tester di voltaggio auto • [SR] Probna lampa (glinerica)
- [SL] Preizkuševalec napetosti • [BH] Automatski Volt Tester • [RU] Авто - Тестер • [MK] Тестер на напон

арт. № Баркод  
art. № Barcode

339901



## RETHREADER KIT SET

- [BG] Метчик за свещи комплект • [RO] Tarozi set • [EL] Κολαούζο επισκευής σπειρωμάτων μπουζί σετ
- [PT] Kit Retificador de velas • [IT] Kit riparazione filettatura candela • [SR] Narezna svrdla set • [SL] Nastavki za vrezovanje navojev
- [BH] Setovi za retreader • [RU] Метчик Для Свечей Зажигания • [MK] Нарезни сврдла

арт. № Баркод  
art. № Barcode

330390



- Content:
- 1 x 14mm Spark plug rethreader
- 4 inserts 3/8"; 7/16"; 1/2"; 3/4" long



## NUMBER STAMP SET

- [BG] Цифри • [RO] Set roansoane cifre • [EL] Στάμπες αριθμών • [PT] Număr de pumn • [IT] • [SR] Brojevi za obeležavanje
- [SL] Udarne številke • [BH] Brojevi markirači • [RU] Цифры • [MK] Ударен сет бројки

Арт. № Size Баркод  
Art. № (mm) Barcode

349201

5



349202

6



## LETTERS STAMP SET

- [BG] Букви хром • [RO] Set roansoane litere • [EL] Στάμπες γραμμάτων • [PT] Carimbo de cartas • [IT] Timbro di lettere
- [SR] Slova za obeležavanje • [SL] Set žigov za pismo • [BH] Pisma markirači • [RU] Буквы • [MK] Ударен сет букви

Арт. № Size Баркод  
Art. № (mm) Barcode

499991

1.5 - 12.5



# IMPACT WRENCH PRO TMP AIW 16

**NEW**

- [BG] Гайковерт пневматичен ударен • [RO] Cheie cu impact pneumatica • [EL] Αερόκλειδο
- [PT] Chave de impacto pneumática • [IT] Chiave ad impatto • [SR] Zavrtač pneumatski • [SL] Udarni vijačnik
- [BH] Zračni udarni ključ • [RU] Ударный Пневмогайковёрт • [MK] Пневматски чекан

**2<sup>ND</sup>**  
GENERATION



**TWIN HAMMER IMPACT MECHANISM**



Art. № Art. №	Nm	Баркод Barcode
344105	1600	

	<b>max. 1600 Nm</b>			<b>2.1 kg</b>
<b>6.3 bar</b>	<b>8500 rpm</b>		<b>169 l/min</b>	<b>COMPOSITE BODY</b>



# IMPACT WRENCH TMP AIW 15

**NEW**

- [BG] Гайковерт пневматичен ударен • [RO] Cheie cu impact pneumatica • [EL] Αερόκλειδο
- [PT] Chave de impacto pneumática • [IT] Chiave ad impatto • [SR] Zavrtač pneumatski • [SL] Udarni vijačnik
- [BH] Zračni udarni ključ • [RU] Ударный Пневмогайковёрт • [MK] Пневматски чекан



**TWIN HAMMER IMPACT MECHANISM**



Art. № Art. №	Nm	Баркод Barcode
344104	1500	

	<b>max. 1600 Nm</b>			<b>2.1 kg</b>
<b>6.3 bar</b>	<b>8500 rpm</b>		<b>169 l/min</b>	<b>COMPOSITE BODY</b>





## MINI IMPACT WRENCH TMP 66

- [BG] Гайковерт пневматичен ударен • [RO] Cheie cu impact pneumatica • [EL] Αερόκλειδο
- [PT] Chave de impacto pneumática • [IT] Chiave ad impatto • [SR] Zavrtać pneumatski • [SL] Udarni vijačnik
- [BH] Zračni udarni ključ • [RU] Ударный Пневмогайковёрт • [MK] Пневматски чекан



TWIN HAMMER IMPACT MECHANISM



Арт. № Art. №	Nm	Баркод Barcode
344100	1100	

	<b>1100 Nm</b>			<b>1.2 kg</b>
	<b>P 0.63 MPa</b>		<b>TWIN HAMMER</b>	<b>COMPOSITE BODY</b>
	<b>10 000 min<sup>-1</sup></b>			

## IMPACT WRENCH

- [BG] Гайковерт пневматичен ударен • [RO] Cheie cu impact pneumatica • [EL] Αερόκλειδο
- [PT] Chave de impacto pneumática • [IT] Chiave ad impatto • [SR] Zavrtać pneumatski • [SL] Udarni vijačnik
- [BH] Zračni udarni ključ • [RU] Ударный Гайковёрт • [MK] Пневматски чекан



Арт. № Art. №	Nm	Баркод Barcode
344103	2300	

	<b>2300 Nm</b>	
	<b>13.5 kg</b>	
	<b>5000 min<sup>-1</sup></b>	<b>10 cfm 283 L/min</b>

## BENCH VICE SWIVEL BASE

- [BG] Менгеме въртящо • [RO] Menghina de banc rotativa • [EL] Μέγγενη • [PT] Bench vice M type • [IT] Bench vice
- [SR] Stega stona • [SL] Primež • [BH] Rotirajuća klupa • [RU] Тиски • [MK] Менгеме

арт. № art. №	L (mm)	Тегло Weight (kg)	Баркод Barcode
310404	100	8	
310405	125	12	



## BENCH VICE SWIVEL BASE

- [BG] Менгеме въртящо • [RO] Menghina de banc rotativa • [EL] Μέγγενη • [PT] Bench vice M type • [IT] Bench vice
- [SR] Stega stona • [SL] Primež • [BH] Primež • [RU] Тиски • [MK] Менгеме

арт. № art. №	L (mm)	Тегло Weight (kg)	Баркод Barcode
310406	150	19	
310407	200	30	





## RECHARGEABLE WORK LAMP

- [BG] Акумулаторна работна лампа с телескопичен магнит • [RO] Lampă de lucru cu LED și acumulator
- [EL] Μαγνήτης και φακός τηλεσκοπικός • [PT] Lanterna de trabalho • [IT] Torcia magnetica • [SR] Punjiva lampa
- [SL] Delovna luč • [BH] Svjetiljka • [RU] Аккумуляторная лампа с телескопическим магнитом
- [MK] Светилка со батерии за полнење и телескопски магнет

Art. № Art. №	L (mm)	Баркод Barcode
232501	230	



<b>3W COB</b> <b>1W LED</b>	<b>CHARGING TIME</b> <b>3.5 h</b>	<b>pick up extension</b> 
<b>3.7V</b> <b>700mAh</b> <b>Li-ion</b>	 <b>4h (1W LED)</b>	 <b>2h (3W COB)</b>

## RECHARGEABLE WORK LAMP

- [BG] Акумулаторна работна лампа • [RO] Lampa de lucru cu acumulator • [EL] Φακός επαναφορτιζόμενος με μαγνήτη και γάντζο
- [PT] Lanterna de trabalho • [IT] Ricaricabile lampade • [SR] Lampa • [SL] Delovna luč • [BH] Svjetiljka • [RU] Аккумуляторная Лампа
- [MK] Светилка со батерии за полнење

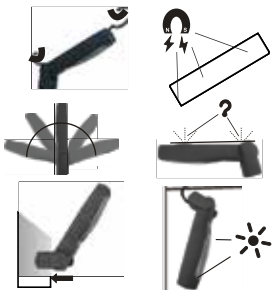

Арт. № Баркод  
Art. № Barcode

232500

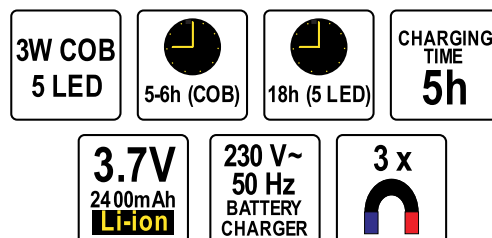

## RECHARGEABLE WORK LAMP

- [BG] Акумулаторна работна лампа • [RO] Lanterna LED cu magnet • [EL] Φακός επαναφορτιζόμενος με μαγνήτη και γάντζο • [PT] Lanterna de trabalho • [IT] Ricaricabile lampade • [SR] Lampa • [SL] Delovna luč • [BH] Svjetiljka • [RU] Аккумуляторная Лампа • [MK] Светилка со батерии за полнење



Арт. № Баркод  
Art. № Barcode

232506

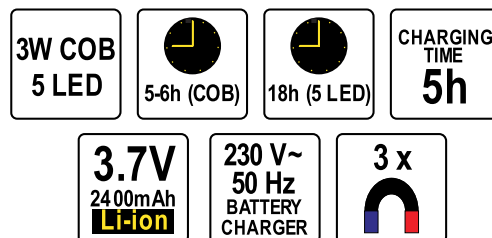

## LED HEAD LIGHT

- [BG] Челник акумулаторен • [RO] Lampa frontala LED • [EL] LED φακός κεφαλής επαναφορτιζόμενος
- [PT] LED farol recarregável • [IT] LED testa ricaricabile • [SR] Bežična LED Lampa • [SL] LED svetilka za naglavo
- [BH] Svjetiljka • [RU] Налобный Фонарь • [MK] Челна светилка со батерии за полнење



Арт. № Баркод  
Art. № Barcode

232503

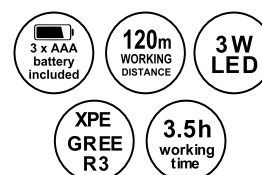



11

ГРАДИНА  
GARDEN





## GARDEN SAW

- [BG] Бичкия двойна дръжка • [RO] Fierastrau tip arc • [EL] Τοξοπίοιο • [PT] Serra de arco • [IT] Ferastrau coarba cu protectie
- [SR] Testera ručna za drvo • [SL] Žaga lokarica • [BH] Ručna Testera • [RU] Садовая пила • [HR] • [MK] Пила за дрво

арт. № art. №	L (mm)	Баркод Barcode
371313	525	
371314	600	
371315	750	



## PRUNING SHEARS

- [BG] Ножица градинска • [RO] Foarfeca de gradina • [EL] Ψαλίδι κλαδέματος • [PT] Tesoura de jardim
- [IT] Cesoiе • [SR] Makaze voćarske • [SL] Vrtne škarje • [BH] Vrtne makaze • [RU] Садовые ножницы
- [HR] Makaze • [MK] Градинарски ножици со механизам



арт. № art. №	L (mm)	Баркод Barcode
370510	200	



AL

SK5  
STEEL

## PRUNING SHEARS

- [BG] Ножица лозарска • [RO] Foarfeca de gradina • [EL] Ψαλίδι κλαδέματος • [PT] Tesoura de jardim • [IT] Cesoiе
- [SR] Makaze voćarske • [SL] Vrtne škarje • [BH] Vrtne makaze • [RU] Садовые ножницы
- [HR] Makaze • [MK] Градинарски ножици со механизам



арт. № art. №	L (mm)	Баркод Barcode
370520	210	



AL

SK5  
STEEL

## ANVIL PRUNING SHEARS

- [BG] Ножица градинска тип "наковалня" • [RO] Foarfeca de gradina tip nicovala • [EL] Ψαλίδι κλαδέματος • [PT] Tesoura de jardim
- [IT] Cesoie • [SR] Makaze vočarske • [SL] Vrtne škarje • [BH] Vrtne makaze • [RU] Садовые ножницы
- [HR] Makaze • [MK] Градинарски ножици со механизам



арт. № art. №	L (mm)	Баркод Barcode
370521	200	



## PRUNING SHEARS

- [BG] Ножица градинска • [RO] Foarfeca de gradina • [EL] Ψαλίδι κλαδέματος • [PT] Tesoura de jardim
- [IT] Cesoie • [SR] Makaze vočarske • [SL] Vrtne škarje • [BH] Vrtne makaze • [RU] Садовые ножницы
- [HR] Makaze • [MK] Градинарски ножици со механизам



Арт. № Art. №	L (mm)	Баркод Barcode
370522	220	



## PRUNING SHEARS MINI

- [BG] Ножица мини градинска • [RO] Mini foarfeca de gradina • [EL] Ψαλίδι κλαδέματος • [PT] Tesoura de jardim mini
- [IT] Cesoie mini • [SR] Makaze za lozu • [SL] Škarje mini • [BH] Vrtne makaze mini
- [RU] Садовые ножницы • [MK] Мини градинарски ножици



Арт. № Art. №	L (mm)	Баркод Barcode
370523	190	



## GARDEN SHEARS MINI

- [BG] Ножица мини цветарска • [RO] Foarfeca de gradina • [EL] Φαλίδι κλαδέματος mini • [PT] Tesoura de jardim mini
- [IT] Cesioie mini • [SR] Makaze mini • [SL] Škarje mini • [BH] Vrtne makaze mini
- [RU] Садовые ножницы • [MK] Мини цветарски ножници



Art. № L Баркод  
Art. № (mm) Barcode

370524 190



## UPPER BLADE FOR PRUNING SHEARS TMP20

- [BG] Резервно острие за ножица лозарска TMP20 • [RO] Lama superioara de rezerva pentru foarfeca de gradina
- [EL] Λάμα για φαλίδια κλαδέματος • [PT] Lâmina superior para tesoura de poda • [IT] Lama superiore per cesioie da potatura
- [SR] Nož za makaze voćarske • [SL] Rezilo za škarje za obrezovanje • [BH] Nož • [RU] Лезвие для обрезки ножниц
- [MK] Резервен нож



Art. № L Баркод  
Art. № (mm) Barcode

370515 200



## PRUNING SHEARS ROTATABLE HANDLE TMP20-R

- [BG] Ножица лозарска с въртяща се дръжка • [RO] Foarfeca de gradina maner rotativ
- [EL] Φαλίδι κλάδου περιστρεφόμενης λαβής • [PT] Tesoura com cabo rotativo • [IT] Forbice a manico rotante
- [SR] Rotirajuće makaze • [SL] Rotacijski škarj • [BH] Vrtne makaze • [RU] Ножницы с вращающейся ручкой
- [MK] Ножици со ротирачка рачка



Въртяща се дръжка  
Rotating handle



Art. № L Баркод  
Art. № (mm) Barcode

370516 200



Position 1  
Small hand



Position 2  
Big hand



## UPPER BLADE FOR PRUNING SHEARS

- [BG] Резервно острие за ножица лозарска • [RO] Lama superioara de rezerva pentru foarfeca de gradina • [EL] Λάμα για φαλίδια κλαδέματος
- [PT] Lâmina superior para tesoura de poda • [IT] Lama superiore per cesoie da potatura • [SR] Nož za makaze • [SL] Rezilo za škarje za obrezovanje
- [BH] Nož • [RU] Лезвие для обрезки ножиц • [MK] Резервен нож



Арт. № Art. №	L (mm)	Баркод Barcode
370517	200	



## FORGED LOOPER TELESCOPIC

- [BG] Ножица за клони с телескопична дръжка • [RO] Foarfeca pentru crengi cu maner telescopic
- [EL] Φαλίδα κλάδου τηλεσκοπική αλουμινίου • [PT] Lopper forjado telescópico • [IT] Lopper forgiato telescopico
- [SR] Makaze sa teleskopskom drškom • [SL] Škarje s teleskopskim ročajem • [BH] Vrtne makaze
- [RU] Ножницы с телескопической ручкой • [MK] Ножици со телескопска рачка



Арт. № Art. №	L (mm)	Баркод Barcode
389916	620 - 870	



## DROP FORGED HEDGE SHARE

- [BG] Ножица за храсти с алуминиеви дръжки • [RO] Foarfeca pentru pomi otel forjat • [EL] Φαλίδα μπортούρας αλουμινίου
- [PT] Queda de tesoura de hedge forjada • [IT] Cesoia da siepe forgiata a goccia • [SR] Makaze za ogradu • [SL] Škarje
- [BH] Makaze • [RU] Ножницы • [MK] Ножици



Арт. № Art. №	L (mm)	Баркод Barcode
389917	620	





## EXTENDABLE TREE PRUNER

- [BG] Ножица и трион за високо рязане • [RO] Fierastrau pentru crengi cu maner extensibil • [EL] Ψαλίδι κορυφής με πριόνι και κοντάρι
- [PT] Tesoura e serra para corte alto • [IT] Forbici e seghe per taglio alto • [SR] Makaze i testera za grane
- [SL] Škarje in žaganje za visoko rezanje • [BH] • [RU] Ножицы и пилы для резки • [HR] Škare i pile za visoke rezanje
- [MK] Ножици и пила за сечење на висина





Art. № Art. №	L (cm)	L Saw knife Нож (cm)	Тегло Weight (kg)	Баркод Barcode
371531	163 - 247	24	1.5	

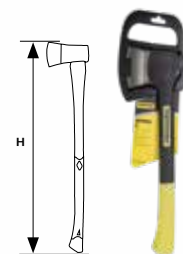

## AXE CHOPPING

- [BG] Брадва олекотена • [RO] Topor maner fibra • [EL] Τσεκούρι • [PT] Machado • [IT] Aciа • [SR] Sekira
- [SL] Bradva • [BH] Sjekira za drva • [RU] Топор • [HR] Makaze • [MK] Секира



Art. № Art. №	H (mm)	Тегло Weight (gr)	Баркод Barcode
373402	350	650	

- Forged SK5 steel for superior edge retention
- Blade with Teflon coating
- Shock-absorbing fiberglass handle is light weight yet stronger than steel
- Evenly balanced construction
- Non slip grip reduces hand strain and makes comfortable and powerful control



## AXE SPLITTING

- [BG] Брадва олекотена • [RO] Topor pentru despicat • [EL] Τσεκούρι • [PT] Machado • [IT] Aciа
- [SR] Sekira • [SL] Bradva • [BH] Sjekira za drva • [RU] Топор • [HR] Makaze • [MK] Секира

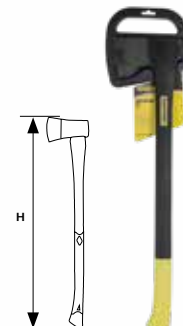

Art. № Art. №	H (mm)	Тегло Weight (gr)	Баркод Barcode
373403	710	1600	

- Forged SK5 steel for superior edge retention
- Blade with Teflon coating
- Shock-absorbing fiberglass handle is light weight yet stronger than steel
- Evenly balanced construction
- Non slip grip reduces hand strain and makes comfortable and powerful control



## AXE STEEL, TUBULAR HANDLE

- [BG] Брадва • [RO] Toporisca • [EL] Τσεκούρι • [PT] Machado • [IT] Aciа • [SR] Sekira • [SL] Bradva • [BH] Sjekira za drva
- [RU] Топор • [HR] Makaze • [MK] Секира

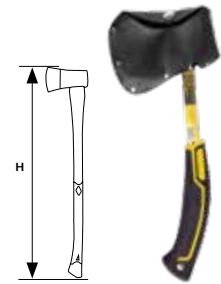

Арт. № Art. №	H (mm)	Баркод Barcode
381314	340	

DIN

## HATCHET HAMMER

- [BG] Томахавка • [RO] Toporisca cu ciocan • [EL] Τσεκούρι-Σφυρί • [PT] Martelo machado • [IT] Martello a mazza
- [SR] Sekira • [SL] Kladivo • [BH] Sjekira za drva • [RU] Топорный молоток • [MK] Чешласт чекан



Арт. № Art. №	Тегло Weight (gr)	Баркод Barcode
381321	570	

DIN

## AXE WITH FIBERGLASS HANDLE

- [BG] Брадва дръжка фибростъкло • [RO] Topor maner fibra • [EL] Τσεκούρι με πλαστική λαβή • [PT] Machado com cabo de fibra de vidro
- [IT] Aciа con manico in fibra di vetro • [SR] Sekira sa ručkom od fibreglasа • [SL] Sekiramo z ročajem iz steklenih vlaken • [BH] Sjekira za drva
- [RU] Топор с ручкой из стекловолокна • [MK] Секира со рачка од фиберглас

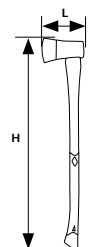

Арт. № Art. №	Тегло Weight (gr)	H (mm)	L (mm)	Баркод Barcode
381322	680	410	145	

DIN

## AXE WITH FIBERGLASS HANDLE

- [BG] Брадва дръжка фибростъкло • [RO] Topor maner fibra • [EL] Τσεκούρι με πλαστική λαβή • [PT] Machado com cabo de fibra de vidro
- [IT] Ascia con manico in fibra di vetro • [SR] Sekira sa ručkom od fibreglasa • [SL] Sekiramo z ročajem iz steklenih vlaken • [BH] Sjekira za drva
- [RU] Топор с ручкой из стекловолокна • [MK] Секира со рачка од фиберглас



Арт. № Art. №	Тегло Weight (gr)	H (mm)	L (mm)	Баркод Barcode
381323	1130	850	165	

DIN

## AXE WITH FIBERGLASS HANDLE

- [BG] Брадва дръжка фибростъкло • [RO] Topor maner fibra • [EL] Τσεκούρι με πλαστική λαβή • [PT] Machado com cabo de fibra de vidro
- [IT] Ascia con manico in fibra di vetro • [SR] Sekira sa ručkom od fibreglasa • [SL] Sekiramo z ročajem iz steklenih vlaken • [BH] Sjekira za drva
- [RU] Топор с ручкой из стекловолокна • [MK] Секира со рачка од фиберглас



Арт. № Art. №	Тегло Weight (gr)	H (mm)	L (mm)	Баркод Barcode
381342	600	370	155	

DIN

## AXE WITH FIBERGLASS HANDLE

- [BG] Брадва дръжка фибростъкло • [RO] Topor maner fibra • [EL] Τσεκούρι με λαβή από γυαλί • [PT] Machado com cabo de fibra de vidro
- [IT] Ascia con manico in fibra di vetro • [SR] Sekira sa ručkom od fibreglasa • [SL] Sekiramo z ročajem iz steklenih vlaken • [BH] Sjekira za drva
- [RU] Топор с ручкой из стекловолокна • [MK] Секира со рачка од фиберглас





Арт. № Art. №	Тегло Weight (gr)	H (mm)	L (mm)	Баркод Barcode
381345	1250	700	190	

DIN

## MAUL WITH FIBERGLASS HANDLE

- [BG] Брадва тип "κλιν" дръжка от фибростъкло • [RO] Secure cu maner fibra • [EL] Τσεκουροσχίστης με πλαστική λαβή
- [PT] Machado com cabo de fibra de vidro • [IT] Acia con manico in fibra di vetro • [SR] Sekira malj sa ručkom od fiberglasa
- [SL] Bradva z ročajem iz steklenih vlaken • [BH] Sjekira za drva • [RU] Топор с ручкой из стекловолокна
- [HR] Makaze s ručkom od fiberglasa • [MK] Секира со рачка од фиберглас



арт. № art. №	Тегло Weight (gr)	H (mm)	L (mm)	Баркод Barcode
381346	1000	380	150	
381347	2000	700	190	
381324	2700	850	190	

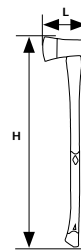

**DIN**

## AXE WITH FIBERGLASS HANDLE

- [BG] Брадва дръжка фибростъкло • [RO] Topor maner fibra • [EL] Τσεκουροβαριά με πλαστική λαβή • [PT] Machado com cabo de fibra de vidro
- [IT] Ascia con manico in fibra di vetro • [SR] Sekira malj sa ručkom od fiberglasa • [SL] Sekiramo z ročajem iz steklenih vlaken
- [BH] Sjekira za drva • [RU] Топор с ручкой из стекловолокна • [MK] Секира со рачка од фиберглас



Арт. № Art. №	Тегло Weight (gr)	H (mm)	L (mm)	Баркод Barcode
381348	3000	880	210	



**DIN**



## ROUND SHOVEL FIBERGLASS HANDLE WITH PEDAL

- [BG] Лопата права със степенки и дръжка фибростъкло • [RO] Cazma cu coada din fibra de sticla • [EL] Πτύο πατητό με πλαστικό στείλιари
- [PT] Pá rodada com um cabo de fibra de vidro • [IT] Pala rotonda con manico in fibra di vetro • [SR] Lopata sa rotirajućom ručkom od fibreglasa
- [SL] Lopatica z ročajem iz steklenih vlaken • [BH] Ašov • [RU] Лопата с ручкой из стекловолокна • [MK] Лопата со подесувачка FIBER GLASS рачка

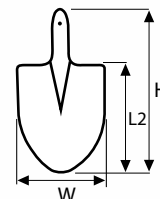

Art. №	L	L2	W	H	Ø Дръжка	Баркод
Art. №	(mm)	(mm)	(mm)	(mm)	(mm)	Barcode

380800	1500	290	235	645	32	
--------	------	-----	-----	-----	----	---

## SQUARE SHOVEL FIBERGLASS HANDLE WITH PEDAL

- [BG] Лопата със степенки и дръжка фибростъкло • [RO] Lopata cu coada din fibra de sticla • [EL] Ένα τετράγωνο φτυάρι με λαβή από γυαλί
- [PT] Uma pá quadrada com cabo de fibra de vidro • [IT] Una pala quadrata con manico in fibra di vetro • [SR] Kvadratna lopata sa ručkom od fibreglasa
- [SL] Kvadratna lopatica z ročajem iz steklenih vlaken • [BH] Ašov • [RU] Квадратная лопата с ручкой из стекловолокна
- [MK] Четвртаста лопата со подесувачка FIBER GLASS рачка

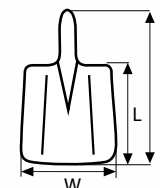

Art. №	L	L2	W	H	Ø Дръжка	Баркод
Art. №	(mm)	(mm)	(mm)	(mm)	(mm)	Barcode

380801	1500	285	2400	650	32	
--------	------	-----	------	-----	----	---

## ROUND SHOVEL WOODEN HANDLE WITH PEDAL

- [BG] Лопата права със степенки и дървена дръжка • [RO] Cazma cu coada din de lemn de sticla • [EL] Πτύο τετράγωνο ξύλιнос λαβή
- [PT] Pá rodada com um cabo de madeira de vidro • [IT] Pala rotonda con manico di legno di vetro • [SR] Lopata drveni
- [SL] Lopatica z ročajem lesena vlaken • [BH] Ašov • [RU] Круглая лопата с деревянной ручкой
- [MK] Лопата со подесувачка дрвена рачка

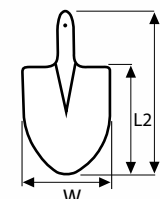

Art. №	L	L2	W	H	Ø Дръжка	Баркод
Art. №	(mm)	(mm)	(mm)	(mm)	(mm)	Barcode

380802	1150	290	235	645	37	
--------	------	-----	-----	-----	----	---

PINE  
WOOD

## SQUARE SHOVEL WOODEN HANDLE WITH PEDAL

- [BG] Лопата квадрат със степенки и дървена дръжка • [RO] Lopata cu coada din de lemn de sticla
- [EL] Ένα τετράγωνο φτυάρι ξύλινος από γυαλί • [PT] Uma pá quadrada com cabo de madeira de vidro
- [IT] Una pala quadrata con manico di legno di vetro • [SR] Kvadratna lopata drveni
- [SL] Kvadratna lopatica z ročajem lesena vlaken • [BH] Ašov
- [RU] Квадратная лопата с деревянной ручкой
- [MK] Квадратна лопата со рачка од дрво

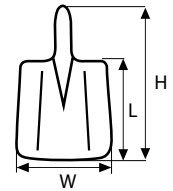

Art. № L L2 W H Ø Дръжка Баркод  
Art. № (mm) (mm) (mm) (mm) (mm) Barcode

380803 1150 305 175 535 37 

**PINE WOOD** **Mn #50**

## LAWN RAKE

- [BG] Гребло за листа с дървена дръжка • [RO] Grebla peluza • [EL] Τσουγκράνα • [PT] Ancinho • [IT] Rastrello
- [SR] Гребло за лисја • [SL] Grablje • [BH] Grabulje • [RU] Грабли для листьев с деревянной ручкой
- [MK] Гребло за лисја



Art. № L Ø Дръжка Баркод  
Art. № (mm) (mm) Barcode

380804 1200 24 

**22 TEETH** **PINE WOOD**

## LAWN RAKE

- [BG] Гребло за листа усилено • [RO] Grebla peluza • [EL] Τσουγκράνα • [PT] Ancinho
- [IT] Rastrello • [SR] Гребло за лисја • [SL] Grablje • [BH] Grabulje • [RU] Грабли для листьев • [MK] Гребло за лисја

Art. № L Баркод  
Art. № (mm) Barcode

380805 1400 



**NEW**

**14 TEETH** **FIBERGLASS HANDLE**

## GARDEN FORK

- [BG] Вила • [RO] Furculiță de grădină • [EL] Φορντό κήπου • [PT] Garfo de jardim • [IT] Forcella da giardino • [SR] Vrtna viljuška • [SL] Vrtna tilnika • [BH] Vrtna viljuška • [RU] Садовая вилка • [MK] Баштенска виљушка

Art. № L Баркод  
Art. № (mm) Barcode

380806 1900 



**NEW**

**4 TEETH** **FIBERGLASS HANDLE**

## SNOW SHOVEL

- [BG] Лопата за сняг с алуминиева дръжка • [RO] Lopata de zapada cu coada din aluminiu • [EL] Πτύο χιονιού με λαβή αλουμινίου
- [PT] Pá de neve • [IT] Pala da neve • [SR] Lopata za sneg • [SL] Snežna lopatica • [BH] Ašov
- [RU] Лопата для снега • [MK] Лопата за снег

Арт. № Art. №	Размер Size (cm)	Баркод Barcode
------------------	------------------------	-------------------

380461

120x32x40



AL

## SNOW SHOVEL

- [BG] Гребло за сняг с метална дръжка • [RO] Lopata de zapada • [EL] Πτύο χιονιού • [PT] Pá de neve • [IT] Pala da neve
- [SR] Lopata za sneg • [SL] Snežna lopatica • [BH] Ašov • [RU] Лопата для снега • [MK] Лопата за снег

Арт. № Art. №	Размер Size (cm)	Баркод Barcode
------------------	------------------------	-------------------

380460

130x32x46



STEEL





# 12

*РАБОТНИ ОБЛЕКЛА И ОБУВКИ*  
*WORKING CLOTHES & SAFETY SHOES*





## ПРЕИМУЩЕСТВА НА ПРОДУКТИТЕ:

- **КАЧЕСТВО** – потвърдено от нашия процес за осигуряване, обхващащ всички етапи на производство и доставка
- **ФУНКЦИОНАЛНОСТ** – голям брой джобове, предназначени за строителни инструменти и аксесоари
- **РАЗНООБРАЗИЕ** – даващо възможност за избор на дрехи спрямо метеорологични условия и сезони на годината
- **ТРАЙНОСТ** – използвани само най-трайните материали, осигуряващи дългосрочна употреба
- **ДИЗАЙН** – модерен дизайн и добре съставени цветове
- **ИНОВАЦИЯ** – приложение на решения, осигуряващи допълнителни функционалности и комфорт при носене
- **ИНТУИТИВЕН ИЗБОР** – опаковки на продуктите и етикети, ясно комуникиращи най-важните характеристики на продуктите
- **БОГАТ ИЗБОР ОТ РАЗМЕРИ** – позволяващ оптимално подравняване на облеклото с формата и фигурата на потребителя

## PRODUCTS' ADVANTAGES INCLUDE:

- **QUALITY** – ensured by our quality assurance process covering all manufacturing and delivery stages
- **FUNCTIONALITY** – a large number of pockets and holes dedicated to building tools and accessories
- **DIVERSITY** – making it possible to align clothes with weather conditions and seasons of the year
- **DURABILITY** – application of only the most durable materials ensuring long-term use
- **DESIGN** – modern design and well composed colors
- **INNOVATIVENESS** – application of solutions ensuring additional functionalities and comfort while wearing
- **INTUITIVE CHOICE** – product packaging and tags clearly communicating most important features of the products
- **WIDE CHOICE OF SIZES** – allowing for optimal clothing-alignment with the user's shape and figure

PANTS/ПАНТАЛОНИ/CM						
	S/	M/	L/	XL/	2XL/	3XL/
WAIST	42	44	46	48	51	54
Outseam (waist including)	104	106	108	110.5	113	115.5
Hip	51	53	55	57	60	63
Bottom	21	22	23	24	25	26
Front raise (waist including)	28	29	30	31	32	33
BIB PANTS/ГАЩЕРИЗОНИ/CM						
	S	(M)	(L)	(XL)	(2XL)	(3XL)
WAIST	43	45	47	49	52	55
Outseam (waist including)	104	106	108	110.5	113	115.5
Hip	54	56	58	60	63	66
Thigh	31	32	33	34	35	36
Bottom	21	22	23	24	25	26
Front raise (waist including)	29	30	31	32	33	34

JACKETS/ЯКЕТА /CM						
	S	M	L	XL	2XL	3XL
1/2 Chest	55	58	61	64	67	70
1/2 Bottom	55	58	61	64	67	70
Center Length	70	72	74	76	78	80
Sleeve Length	62.00	64.00	66.00	68.00	70.00	72.00
Shoulder Width	50.5	52	53.5	55	56.5	58
Collar Height	8	8	8	8	8	8

**topmaster**  
professional

Selected categories of safety shoes according to ISO 20345 / Избрани категории предпазни обувки според ISO 20345

Category Категория	Requirements / Изисквания					
	Toe cups Бомбета 200 J	Anti- puncture insoles Стелки против пробив	Closed heel areas Затворени пети	Antistatic properties Антиелектростатически свойства	Energy absorbtion of heel areas Енергопоглъщане в петите	Water penetration & absorbtion Водопроницаемост и попиване
SB	●					
S1	●		●	●	●	
S3	●	●	●	●	●	●

Selected categories of professional shoes according to ISO 20347 / Избрани категории професионални обувки според ISO 20347

Category Категория	Requirements / Изисквания					
	Toe cups Бомбета 200 J	Anti- puncture insoles Стелки против пробив	Closed heel areas Затворени пети	Antistatic properties Антиелектростатически свойства	Energy absorbtion of heel areas Енергопоглъщане в петите	Water penetration & absorbtion Водопроницаемост и попиване
OB						
O1			●	●	●	

Selected additional requirements according to ISO 20345 and ISO 20347 / Избрани допълнителни изисквания съгласно ISO 20345 и ISO 20347

Category Символ	Requirements / Изисквания
P	Antipuncture insole / Стелки против пробив
FO	Fuel resistance / Защита против петролни продукти
SRA	Slip resistance on ceramic tiles floor covered with SLS / Противоплъзгане на подове от керамични плочки, покрити с разтвор с натриев лаурил сулфат (NaSL)
SRC	Slip resistance on ceramic tile floors covered in SLS & on steel floors covered in glycerol / Противоплъзгане на подове от керамични плочки, покрити с натриев лаурил сулфат (NaSL) и на стомана, покрити с глицерол

# PANTS

- [BG] Работен панталон • [RO] Pantaloni de lucru • [EL] Παντελони εργασιας • [PT] Calças
- [IT] Pantaloni da lavoro • [SR] Radne pantalone • [SL] Delovne hlače • [BH] Radne pantalone
- [RU] Штаны • [HR] Radne hlače • [MK] Работни панталони



- ✓ 65% POLYESTER
- ✓ 35% COTTON CANVAS FABRIC
- ✓ 260 g/m<sup>2</sup>

арт. № art. №	Размер / Size	Баркод Barcode
557201	M	
557202	L	
557203	XL	
557204	XXL	
557205	XXXL	



Smartphone pocket  
Джоб за смартфон



Reinforced fabric on knees  
Усилени колена



Pocket for knee pads  
Джобове за подложки на колената



Additional belt size adjustment  
Допълнително регулиране на размера на колана



Tool holder  
Държач за инструмент

POLYESTER 65%  
COTTON 35%

260 g/m<sup>2</sup>

OXFORD PROTECTION

3x STRONG



Идеално съчетани с:  
Ideally complemented with:

стр./page 240

# BIBPANTS

- [BG] Работен полугащеризон • [RO] Pantalon cu pieptar de lucru • [EL] Φορμα τιραντα εργασιας • [PT] Calças Jardineiras
- [IT] Emisfero di lavoro • [SR] Radne pantalone sa tregerima • [SL] Delovna polobla • [BH] Radna hemisfera
- [RU] Комбинезон на лямках • [HR] Radna hemisfera • [MK] Работна хемисфера



- ✓ 65% POLYESTER
- ✓ 35% COTTON CANVAS FABRIC
- ✓ 260 g/m<sup>2</sup>

арт. № art. №	Размер / Size	Баркод Barcode
557801	M	
557802	L	
557803	XL	
557804	XXL	
557805	XXXL	
557806	XXXXL	



Smartphone pocket  
Мултифункционални джобове



Reinforced fabric on knees  
Подсилена материя на коленете



Pocket for knee pads  
Джобове за подложки на колената



Reflective tape  
Светлоотразяваща лента



Additional belt adjustment  
Допълнително регулиране на размера на колана



Tool holder  
Държач за инструмент

POLYESTER 65%  
COTTON 35%

260 g/m<sup>2</sup>

OXFORD PROTECTION

3x STRONG



Идеално съчетани с:  
Ideally complemented with:

стр./page 240



## BIBPANTS

- [BG] Работен полугащеризон • [RO] Pantalon cu pieptar de lucru • [EL] Форма τραντα εργασιας • [PT] Calças Jardineiras
- [IT] Emisfero di lavoro • [SR] Radne pantalone sa tregerima • [SL] Delovna polobla • [BH] Radna hemisfera
- [RU] Комбинезон на лямках • [HR] Radna hemisfera • [MK] Работна хемисфера

- ✓ 80% POLYESTER
- ✓ 20% COTTON FABRIC
- ✓ 240 g/m<sup>2</sup>

арт. № art. №	Размер / Size	Баркод Barcode
557701	M	
557702	L	
557703	XL	
557704	XXL	
557705	XXXL	
557706	XXXXL	

Идеално съчетани с:  
Ideally complemented  
with:



стр./page  
240



Suspenders  
Презрамки



Multifunctional pockets  
Многофункционални джобове



Pocket for knee pads  
Джобове за подложки на коленете

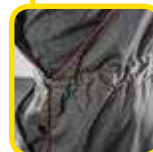

Elastic band in waistline  
Еластична лента на пояса

POLYESTER  
80%  
COTTON  
20%

240 g/m<sup>2</sup>



## COVERALL

- [BG] Работен гащеризон • [RO] Combinezon de lucru • [EL] Форма ολοσωμη εργασιας • [PT] Fato de Macaco • [IT] Tuta da lavoro • [SR] Radni kombinezon • [SL] Delovni kombinezoni • [BH] Radni kombinezoni
- [RU] Комбинезон с рукавами • [HR] Radni kombinezoni • [MK] Работни комбинезони

2<sup>ND</sup>  
GENERATION

- ✓ 65% POLYESTER
- ✓ 35% COTTON CANVAS FABRIC
- ✓ 260 g/m<sup>2</sup>

арт. № art. №	Размер / Size	Баркод Barcode
557601	M	
557602	L	
557603	XL	
557604	XXL	
557605	XXXL	
557606	XXXXL	



Smartphone pocket  
Джоб за смартфон



Reinforced fabric on the knees  
Усиления колена



Pocket for knee pads  
Джобове за подложки на колената



Reflective tape  
Светлоотразителна лента



Reinforced fabric on elbows  
Подсилена материя на лактите



Multifunctional pockets  
Многофункционални джобове

POLYESTER  
65%  
COTTON  
35%

260 g/m<sup>2</sup>





# VEST

- [BG] Работен елек • [RO] Vesta de lucru • [EL] Γιλέκο εργασίας • [PT] Colete
- [IT] Giacca da lavoro • [SR] Prsluk • [SL] Delovna jakna • [BH] Radna jakna
- [RU] Жилетка • [HR] Radna jakna • [MK] Работна јакна



- ✓ 65% POLYESTER
- ✓ 35% COTTON CANVAS FABRIC
- ✓ 260 g/m<sup>2</sup>

арт. № art. №	Размер / Size	Баркод Barcode
557901	M	
557902	L	
557903	XL	
557904	XXL	
557905	XXXL	



Reflective tape  
Светлоотразителна лента



Reinforced fabric on the shoulders  
Подсилена материя на раменете



Inner mesh pocket  
Вътрешен мрежест джоб



- POLYESTER 65%  
COTTON 35%
- 260 g/m<sup>2</sup>
- OXFORD PROTECTION
- CE

Идеално съчетани с:  
Ideally complemented with:

стр./page  
238 / 239

# JACKET

- [BG] Работно яке • [RO] Jacheta de lucru • [EL] Μπουφάν εργασίας • [PT] Casaco • [IT] Giacca da lavoro
- [SR] Radna jakna • [SL] Delovna jakna • [BH] Radna jakna • [RU] Куртка • [HR] Radna jakna • [MK] Работна јакна



- ✓ 65% POLYESTER
- ✓ 35% COTTON CANVAS FABRIC
- ✓ 260 g/m<sup>2</sup>

арт. № art. №	Размер / Size	Баркод Barcode
557101	M	
557102	L	
557103	XL	
557104	XXL	
557105	XXXL	



Reflective tape  
Светлоотразителна лента



Smartphone pocket  
Джоб за смартфон

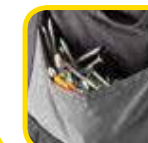

Special pockets for building accessories, for instance screws  
Специални джобове за строителни аксесоари, например винтове



Side ventilation  
Странична вентилация



Reinforced fabric on the elbows  
Подсилена материя на лактите

- POLYESTER 65%  
COTTON 35%
- 260 g/m<sup>2</sup>
- OXFORD PROTECTION
- SMARTPHONE POCKET
- CE

Идеално съчетани с:  
Ideally complemented with:

стр./page  
238 / 239

## SOFTSHELL JACKET

• [BG] Работно яке • [RO] Bluză de lucru cu glugă • [EL] Μπουφάν soft shell εργασία • [PT] Casaco Softshell • [IT] Giacca Softshell • [SR] Radna jakna sa odvojivim rukavima • [SL] Jakna Softshell • [BH] Softshell jakna • [RU] Флисовая куртка • [HR] Softshell jakna • [MK] Јакни Софтшел

- ✓ 94% POLYESTER
- ✓ 6% ELASTANCE

арт. № art. №	Размер / Size	Баркод Barcode
557501	M	
557502	L	
557503	XL	
557504	XXL	
557505	XXXL	

Идеално съчетани с:  
Ideally complemented with:



стр./page  
238 / 239



Spacious inner pockets  
Просторни вътрешни джобове



Inner pocket for smartphone  
Вътрешен джоб за смартфон



Waterproof zippers  
Водоустойчиви ципове



2<sup>ND</sup>  
GENERATION



Inner cuffs  
Вътрешни маншети

## SOFTSHELL JACKET WITH DETACHABLE SLEEVES

• [BG] Работно яке • [RO] Bluză de lucru cu maneci detasabile • [EL] Μπουφάν soft shell εργασία με αποσπώμενα μανίκια • [PT] Casaco Softshell c/ Mangas Removíveis • [IT] Giacca softshell con maniche staccabili • [SR] Radna jakna sa odvojivim rukavima • [SL] Jakna Softshell • [BH] Softshell jakna s odvojivim rukavima • [RU] Флисовая куртка • [HR] Softshell jakna s odvojivim rukavima • [MK] Јакни Софшал со одвојливи ракави

- ✓ 94% POLYESTER
- ✓ 6% ELASTANCE

арт. № art. №	Размер / Size	Баркод Barcode
557401	M	
557402	L	
557403	XL	
557404	XXL	
557405	XXXL	

Идеално съчетани с:  
Ideally complemented with:



стр./page  
238 / 239



Spacious inner pockets  
Вътрешни джобове с голяма вместимост



Inner pocket for smartphone  
Вътрешен джоб за смартфон



Waterproof zippers  
Водоустойчиви ципове



Removal sleeves  
Свалящи ръкави

2<sup>ND</sup>  
GENERATION





## MIDDLE-CUT SAFETY SHOES

- [BG] Работни обувки тип боти • [RO] Pantofi de protectie • [EL] Υποδηματα εργασιας • [PT] Calçado de segurança
- [IT] Stivali da lavoro tipo stivali • [SR] Zaštitna cipela • [SL] Čevlji zaščitni • [BH] Radne čizme
- [RU] Рабочие ботинки типа сапоги • [HR] Radne čizme tipa čizme • [MK] Работни чевли

✓ **Сая:** естествена кожа, водоотблъскваща  
**Подплата:** антиалергична, абсорбираща влагата  
**Стелка:** подвижна, абсорбираща влагата  
**Ходило:** PU/PU, антистатично  
**Бомбе:** метално устойчиво на 200 J  
**Пластина:** метална

✓ **Upper:** natural leather; waterresistant Reflective parts  
**Toe cap:** Steel (resistant up to 200 J, 15 kN)  
**Midsole:** Steel  
**Sole:** PU/PU black and grey, Oil resistant, slipping proof, shock and vibration absorbing.  
 CE certificate

арт. № art. №	КОД/МОДЕЛ EM CODE	ЦВЯТ COLOR	РАЗМЕР SIZE	КАТЕГОРИЯ CATEGORY	Баркод Barcode
553310	WS3	ЧЕРНО/СИВО BLACK/GREY	40	S3 SRC	
553311	WS3	ЧЕРНО/СИВО BLACK/GREY	41	S3 SRC	
553312	WS3	ЧЕРНО/СИВО BLACK/GREY	42	S3 SRC	
553313	WS3	ЧЕРНО/СИВО BLACK/GREY	43	S3 SRC	
553314	WS3	ЧЕРНО/СИВО BLACK/GREY	44	S3 SRC	
553315	WS3	ЧЕРНО/СИВО BLACK/GREY	45	S3 SRC	
553316	WS3	ЧЕРНО/СИВО BLACK/GREY	46	S3 SRC	
553317	WS3	ЧЕРНО/СИВО BLACK/GREY	47	S3 SRC	



## MIDDLE-CUT SAFETY SHOES

- [BG] Работни обувки тип боти • [RO] Pantofi de protectie • [EL] Υποδηματα εργασιας • [PT] Calçado de segurança
- [IT] Stivali da lavoro tipo stivali • [SR] Zaštitna cipela • [SL] Čevlji zaščitni • [BH] Radne čizme
- [RU] Рабочие ботинки типа сапоги • [HR] Radne čizme tipa čizme • [MK] Работни чевли

✓ **Сая:** естествена кожа, водоотблъскваща  
**Подплата:** антиалергична, абсорбираща влагата  
**Стелка:** подвижна, абсорбираща влагата  
**Ходило:** PU/PU, антистатично  
**Бомбе:** метално устойчиво на 200 J  
**Пластина:** метална

✓ **Upper:** natural leather; waterresistant Reflective parts  
**Toe cap:** Steel (resistant up to 200 J, 15 kN)  
**Midsole:** Steel  
**Sole:** PU/PU black and grey, Oil resistant, slipping proof, shock and vibration absorbing.  
 CE certificate

арт. № art. №	КОД/МОДЕЛ EM CODE	ЦВЯТ COLOR	РАЗМЕР SIZE	КАТЕГОРИЯ CATEGORY	Баркод Barcode
553301	WS3	ЧЕРНО/ЖЪЛТО BLACK/YELLOW	40	S3 SRC	
553302	WS3	ЧЕРНО/ЖЪЛТО BLACK/YELLOW	41	S3 SRC	
553303	WS3	ЧЕРНО/ЖЪЛТО BLACK/YELLOW	42	S3 SRC	
553304	WS3	ЧЕРНО/ЖЪЛТО BLACK/YELLOW	43	S3 SRC	
553305	WS3	ЧЕРНО/ЖЪЛТО BLACK/YELLOW	44	S3 SRC	
553306	WS3	ЧЕРНО/ЖЪЛТО BLACK/YELLOW	45	S3 SRC	
553307	WS3	ЧЕРНО/ЖЪЛТО BLACK/YELLOW	46	S3 SRC	
553308	WS3	ЧЕРНО/ЖЪЛТО BLACK/YELLOW	47	S3 SRC	



## LOW-CUT SAFETY SHOES

- [BG] Работни обувки • [RO] Pantofi de protectie • [EL] Υπόδηματα εργασίας • [PT] Calçado de segurança
- [IT] Scarpe da lavoro • [SR] Zaštitna cipela • [SL] Delovni čevlji • [BH] Radne cipele
- [RU] Рабочая обувь • [HR] Radne cipele • [MK] Работни чевли

✓ **Сая:** естествена кожа, водоотблъскваща  
**Подплата:** антиалергична, абсорбираща влагата  
**Стелка:** подвижна, абсорбираща влагата  
**Ходило:** PU/PU, антистатично  
**Бомбе:** метално устойчиво на 200 J  
**Пластина:** метална

✓ **Upper:** natural leather; waterresistant Reflective parts  
**Toe cap:** Steel (resistant up to 200 J, 15 kN)  
**Midsole:** Steel  
**Sole:** PU/ PU black and grey, Oil resistant, slipping proof, shock and vibration absorbing.  
 CE certificate

арт. № art. №	КОД/ МОДЕЛ EM CODE	ЦВЯТ COLOR	РАЗМЕР SIZE	КАТЕГОРИЯ CATEGORY	Баркод Barcode
553320	WSL3	ЧЕРНО/СИВО BLACK/GREY	40	S3 SRC	
553321	WSL3	ЧЕРНО/СИВО BLACK/GREY	41	S3 SRC	
553322	WSL3	ЧЕРНО/СИВО BLACK/GREY	42	S3 SRC	
553323	WSL3	ЧЕРНО/СИВО BLACK/GREY	43	S3 SRC	
553324	WSL3	ЧЕРНО/СИВО BLACK/GREY	44	S3 SRC	
553325	WSL3	ЧЕРНО/СИВО BLACK/GREY	45	S3 SRC	
553326	WSL3	ЧЕРНО/СИВО BLACK/GREY	46	S3 SRC	
553327	WSL3	ЧЕРНО/СИВО BLACK/GREY	47	S3 SRC	

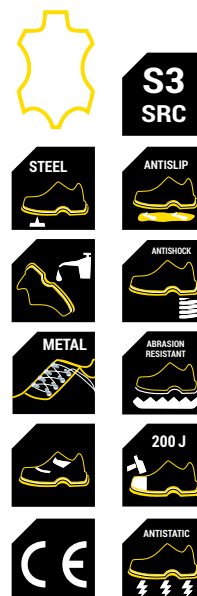

## LOW-CUT SAFETY SHOES

- [BG] Работни обувки • [RO] Pantofi de protectie • [EL] Υπόδηματα εργασίας • [PT] Calçado de segurança
- [IT] Scarpe da lavoro • [SR] Zaštitna cipela • [SL] Delovni čevlji • [BH] Radne cipele
- [RU] Рабочая обувь • [HR] Radne cipele • [MK] Работни чевли

✓ **Сая:** Висококачествен перфориран естествен велур  
**Подплата:** антиалергична, абсорбираща влагата  
**Стелка:** подвижна, абсорбираща влагата  
**Ходило:** PU/PU, антистатично  
**Бомбе:** метално устойчиво на 200 J

✓ **Suede shoe, perforated**  
**Upper:** Perforated suede  
**Outsole:** Dual-density polyurethane  
**Toe Cap:** Steel, 200 J, Penetration-proof insole  
 Composite fibre, ceramic treatment  
 Underfoot cover,  
 CE Certificate

2<sup>ND</sup>  
GENERATION

арт. № art. №	КОД/ МОДЕЛ EM CODE	ЦВЯТ COLOR	РАЗМЕР SIZE	КАТЕГОРИЯ CATEGORY	Баркод Barcode
553420	WSL1P	ЧЕРНО/СИВО BLACK/GREY	40	S1P SRC	
553421	WSL1P	ЧЕРНО/СИВО BLACK/GREY	41	S1P SRC	
553422	WSL1P	ЧЕРНО/СИВО BLACK/GREY	42	S1P SRC	
553423	WSL1P	ЧЕРНО/СИВО BLACK/GREY	43	S1P SRC	
553424	WSL1P	ЧЕРНО/СИВО BLACK/GREY	44	S1P SRC	
553425	WSL1P	ЧЕРНО/СИВО BLACK/GREY	45	S1P SRC	
553426	WSL1P	ЧЕРНО/СИВО BLACK/GREY	46	S1P SRC	
553427	WSL1P	ЧЕРНО/СИВО BLACK/GREY	47	S1P SRC	

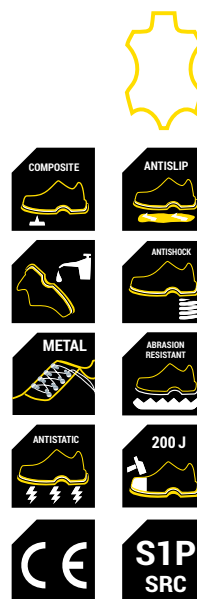



## LOW-CUT SAFETY SHOES

- [BG] Работни обувки • [RO] Pantofi de protectie • [EL] Υποδηματα εργασιας • [PT] Calçado de segurança
- [IT] Scarpe da lavoro • [SR] Zaštitna cipela • [SL] Delovni čevlji • [BH] Radne cipele
- [RU] Рабочая обувь • [HR] Radne cipele • [MK] Работни чевли

✓ Спортен олекотен дизайн  
**САЯ:** силно дишащ текстил  
**ВЪНШЕН ХАСТАР:** силно дишащ текстил  
**ВЪТРЕШЕН ХАСТАР:** 100% полиестер,  
**СТЕЛКА:** подвижна, абсорбираща влагата  
**ХОДИЛО:** Гума +EVA/етилен винил ацетат/  
**БОМБЕ:** Метално 200 J

✓ **Upper:** fly knit  
**Outsole:** Foam Rubber Oil resistant, anti-slip,  
 light, shock absorbing,  
**Lining:** Bk mesh  
**Toecap:** steel, CE certificate

арт. № art. №	КОД/МОДЕЛ EM CODE	ЦВЯТ COLOR	РАЗМЕР SIZE	КАТЕГОРИЯ CATEGORY	Баркод Barcode
553410	WSL1	ЧЕРНО/ЖЪЛТО BLACK/YELLOW	40	S1 SRC	
553411	WSL1	ЧЕРНО/ЖЪЛТО BLACK/YELLOW	41	S1 SRC	
553412	WSL1	ЧЕРНО/ЖЪЛТО BLACK/YELLOW	42	S1 SRC	
553413	WSL1	ЧЕРНО/ЖЪЛТО BLACK/YELLOW	43	S1 SRC	
553414	WSL1	ЧЕРНО/ЖЪЛТО BLACK/YELLOW	44	S1 SRC	
553415	WSL1	ЧЕРНО/ЖЪЛТО BLACK/YELLOW	45	S1 SRC	
553416	WSL1	ЧЕРНО/ЖЪЛТО BLACK/YELLOW	46	S1 SRC	
553417	WSL1	ЧЕРНО/ЖЪЛТО BLACK/YELLOW	47	S1 SRC	



## LOW-CUT SAFETY SHOES

- [BG] Работни обувки • [RO] Pantofi de protectie • [EL] Υποδηματα εργασιας • [PT] Calçado de segurança
- [IT] Scarpe da lavoro • [SR] Zaštitna cipela • [SL] Delovni čevlji • [BH] Radne cipele
- [RU] Рабочая обувь • [HR] Radne cipele • [MK] Работни чевли

✓ Спортен олекотен дизайн  
**САЯ:** силно дишащ текстил  
**ВЪНШЕН ХАСТАР:** силно дишащ текстил  
**ВЪТРЕШЕН ХАСТАР:** 100% полиестер,  
**СТЕЛКА:** подвижна, абсорбираща влагата  
**ХОДИЛО:** Гума +EVA/етилен винил ацетат/  
**БОМБЕ:** Метално 200 J

✓ **Upper:** fly knit  
**Outsole:** Foam Rubber Oil resistant, anti-slip,  
 shock absorbing,  
**Lining:** Bk mesh  
**Toecap:** steel, CE certificate

арт. № art. №	КОД/МОДЕЛ EM CODE	ЦВЯТ COLOR	РАЗМЕР SIZE	КАТЕГОРИЯ CATEGORY	Баркод Barcode
553401	WSL1	ЧЕРНО/СИВО BLACK/GREY	40	S1 SRC	
553402	WSL1	ЧЕРНО/СИВО BLACK/GREY	41	S1 SRC	
553403	WSL1	ЧЕРНО/СИВО BLACK/GREY	42	S1 SRC	
553404	WSL1	ЧЕРНО/СИВО BLACK/GREY	43	S1 SRC	
553405	WSL1	ЧЕРНО/СИВО BLACK/GREY	44	S1 SRC	
553406	WSL1	ЧЕРНО/СИВО BLACK/GREY	45	S1 SRC	
553407	WSL1	ЧЕРНО/СИВО BLACK/GREY	46	S1 SRC	
553408	WSL1	ЧЕРНО/СИВО BLACK/GREY	47	S1 SRC	

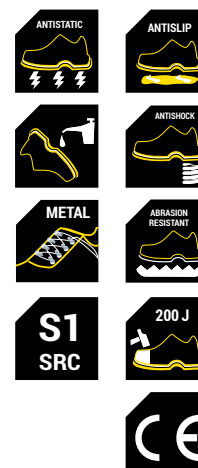

## LOW-CUT SAFETY SHOES

• [BG] Работни обувки • [RO] Pantofi de protectie • [EL] Υποδήματα Εργασίας • [PT] Calçado de segurança • [IT] Scarpe da lavoro • [SR] Zaštitne cipele • [SL] Delovni čevlji • [BH] Radne cipele • [RU] Рабочая обувь • [HR] Radne cipele • [MK] Работни чевл

✓ Спортен олекотен дизайн  
САЯ: силно дишащ текстил  
ВЪНШЕН ХАСТАР: силно дишащ текстил  
ВЪТРЕШЕН ХАСТАР: 100% полиестер,  
СТЕЛКА: подвижна, абсорбираща влагата  
ХОДИЛО: Е-ТРУ  
БОМБЕ: Композитно 200 J

✓ Upper: fly knit  
Outsole: Foam Rubber Oil resistant, anti-slip, light, shock absorbing,  
Lining: Bk mesh  
Toe cap: composite, CE certificate



арт. № art. №	КОД/МОДЕЛ EM CODE	ЦВЯТ COLOR	РАЗМЕР SIZE	КАТЕГОРИЯ CATEGORY	Баркод Barcode
553430	WS-S1C	СИВО/ЖЪЛТО	40	S1	
553431	WS-S1C	СИВО/ЖЪЛТО	41	S1	
553432	WS-S1C	СИВО/ЖЪЛТО	42	S1	
553433	WS-S1C	СИВО/ЖЪЛТО	43	S1	
553434	WS-S1C	СИВО/ЖЪЛТО	44	S1	
553435	WS-S1C	СИВО/ЖЪЛТО	45	S1	
553436	WS-S1C	СИВО/ЖЪЛТО	46	S1	
553437	WS-S1C	СИВО/ЖЪЛТО	47	S1	

2<sup>ND</sup>  
GENERATION



## MIDDLE-CUT SAFETY SHOES

• [BG] Работни обувки • [RO] Pantofi de protectie • [EL] Υποδήματα Εργασίας • [PT] Calçado de segurança • [IT] Scarpe da lavoro • [SR] Zaštitne cipele • [SL] Delovni čevlji • [BH] Radne cipele • [RU] Рабочая обувь • [HR] Radne cipele • [MK] Работни чевл

✓ ВЪТРЕШЕН ХАСТАР: 100% полиестер,  
СТЕЛКА: подвижна, абсорбираща влагата  
ХОДИЛО: Е-ТРУ  
БОМБЕ: Композитно 200 J

✓ Toe cap: composite, CE certificate

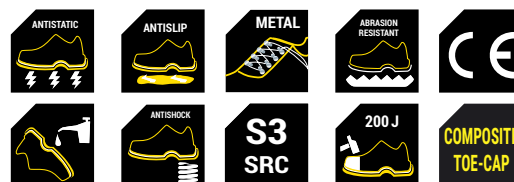

арт. № art. №	КОД/МОДЕЛ EM CODE	ЦВЯТ COLOR	РАЗМЕР SIZE	КАТЕГОРИЯ CATEGORY	Баркод Barcode
553440	WSH1C	ЧЕРНО/ЖЪЛТО	40	S3	
553441	WSH1C	ЧЕРНО/ЖЪЛТО	41	S3	
553442	WSH1C	ЧЕРНО/ЖЪЛТО	42	S3	
553443	WSH1C	ЧЕРНО/ЖЪЛТО	43	S3	
553444	WSH1C	ЧЕРНО/ЖЪЛТО	44	S3	
553445	WSH1C	ЧЕРНО/ЖЪЛТО	45	S3	
553446	WSH1C	ЧЕРНО/ЖЪЛТО	46	S3	
553447	WSH1C	ЧЕРНО/ЖЪЛТО	47	S3	

2<sup>ND</sup>  
GENERATION





## ASSEMBLY GLOVES

• [BG] Монтажни ръкавици • [RO] Mănuși de asamblare • [EL] Γαντια Προστασίας • [PT] Luvas de montagem • [IT] Guanti di montaggio • [SR] Montažne rukavice • [SL] Rokavice za montažo • [BH] Montažne rukavice • [RU] Сборочные перчатки • [HR] Montažne rukavice • [MK] Монтажне рукавице

EN 388:2016



2 1 2 1 X



EN 420



арт. № art. №	КОД/МОДЕЛ EM CODE	МАТЕРИАЛ MATERIAL	РАЗМЕР SIZE	Баркод Barcode
---------------	-------------------	-------------------	-------------	----------------

558101

PG1

Goatskin leather/  
Cotton

10



## SAFETY GLOVES

• [BG] Предпазни ръкавици • [RO] Mănuși de siguranță • [EL] Γαντια Προστασίας • [PT] Luvas de segurança • [IT] Guanti di sicurezza • [SR] Zaštitne rukavice • [SL] Zaščitne rokavice • [BH] Sigurnosne rukavice • [RU] Защитные перчатки • [HR] Zaštitne rukavice • [MK] Сигурносне рукавице

EN 388:2016



4 1 3 2 X



EN 420



арт. № art. №	КОД/МОДЕЛ EM CODE	МАТЕРИАЛ MATERIAL	РАЗМЕР SIZE	Баркод Barcode
---------------	-------------------	-------------------	-------------	----------------

558102

PG2

Cowhide leather/  
Textile

10



## GLOVES FOR WELDERS

• [BG] Ръкавици за заварчици • [RO] Mănuși de siguranță • [EL] Γαντια Προστασίας • [PT] Luvas de segurança • [IT] Guanti di sicurezza • [SR] Rukavice za varioce • [SL] Zaščitne rokavice • [BH] Sigurnosne rukavice • [RU] Защитные перчатки • [HR] Zaštitne rukavice • [MK] Сигурносне рукавице

EN 388:2016



2 1 2 1 X



EN 420

EN407



4 1 2 X 4 X

арт. № art. №	КОД/МОДЕЛ EM CODE	МАТЕРИАЛ MATERIAL	РАЗМЕР SIZE	Баркод Barcode
---------------	-------------------	-------------------	-------------	----------------

558103

PG3

Cowhide leather

10



## SAFETY GLOVES

• [BG] Предпазни ръкавици • [RO] Mănuși de siguranță • [EL] Γάντια Προστασίας • [PT] Luvas de segurança • [IT] Guanti di sicurezza • [SR] Zaštitne rukavice • [SL] Zaščitne rokavice • [BH] Sigurnosne rukavice • [RU] Защитные перчатки • [HR] Zaštitne rukavice • [MK] Сигурносне рукавице



EN 420

2<sup>ND</sup>  
GENERATION



арт. № art. №	КОД/ МОДЕЛ EM CODE	МАТЕРИАЛ MATERIAL	РАЗМЕР SIZE	Баркод Barcode
---------------------	--------------------------	----------------------	----------------	-------------------

558104

PG4

Cowhide smooth  
leather/Textile

10



## IMPACT AND CUT RESISTANT GLOVES

• [BG] Противоударни и противосрезни ръкавици • [RO] Mănuși de siguranță  
• [EL] Γάντια Προστασίας • [PT] Luvas de segurança • [IT] Guanti di sicurezza  
• [SR] Zaštitne rukavice • [SL] Zaščitne rokavice • [BH] Sigurnosne rukavice  
• [RU] Защитные перчатки • [HR] Zaštitne rukavice • [MK] Сигурносне рукавице

EN 388:2016



EN 420

3<sup>RD</sup>  
GENERATION



арт. № art. №	КОД/ МОДЕЛ EM CODE	МАТЕРИАЛ MATERIAL	РАЗМЕР SIZE	Баркод Barcode
---------------------	--------------------------	----------------------	----------------	-------------------

558105

PG5

Cowhide smooth  
leather

10



## SAFETY GLOVES

• [BG] Предпазни ръкавици • [RO] Mănuși de siguranță • [EL] Γάντια  
Προστασίας • [PT] Luvas de segurança • [IT] Guanti di sicurezza • [SR] Zaštitne  
rukavice • [SL] Zaščitne rokavice • [BH] Sigurnosne rukavice • [RU] Защитные  
перчатки • [HR] Zaštitne rukavice • [MK] Сигурносне рукавице

EN 388:2016



2 1 1 2 X

EN 420

2<sup>ND</sup>  
GENERATION



арт. № art. №	КОД/ МОДЕЛ EM CODE	МАТЕРИАЛ MATERIAL	РАЗМЕР SIZE	Баркод Barcode
---------------------	--------------------------	----------------------	----------------	-------------------

558106

PG6

Goatskin leather

10





## DARK LENS SAFETY GLASSES SG01

• [BG] Предпазни очила • [RO] Ochelari de protecție • [EL] Γυαλια Προστασίας • [PT] Óculos de segurança • [IT] Occhiali di sicurezza • [SR] Zaštitne naočare • [SL] Varnostna očala • [BH] Sigurnosne naočare • [RU] Защитные очки • [HR] Zaštitne rukavice • [MK] Сигурносне наочаре



арт. № art. №	КОД/МОДЕЛ EM CODE	ЛЕЩИ LENSES	РАМКА FRAME	Баркод Barcode
561402	SG01	Dark polycarbonate	Nylon	

## SAFETY GLASSES SG02

• [BG] Предпазни очила • [RO] Ochelari de protecție • [EL] Γυαλια Προστασίας • [PT] Óculos de segurança • [IT] Occhiali di sicurezza • [SR] Zaštitne naočare • [SL] Varnostna očala • [BH] Sigurnosne naočare • [RU] Защитные очки • [HR] Zaštitne rukavice • [MK] Сигурносне наочаре



арт. № art. №	КОД/МОДЕЛ EM CODE	МАТЕРИАЛ MATERIAL	РАМКА FRAME	Баркод Barcode
561403	SG02	Transparent polycarbonate	Nylon	

## SAFETY GOGGLES SG03

• [BG] Предпазни очила • [RO] Ochelari de protecție • [EL] Γυαλια Προστασίας • [PT] Óculos de segurança • [IT] Occhiali di sicurezza • [SR] Zaštitne naočare • [SL] Varnostna očala • [BH] Sigurnosne naočare • [RU] Защитные очки • [HR] Zaštitne rukavice • [MK] Сигурносне наочаре



арт. № art. №	КОД/МОДЕЛ EM CODE	ЛЕЩИ LENSES	РАМКА FRAME	Баркод Barcode
561404	SG03	Transparent polycarbonate	Elastic vinyl	

## SAFETY GLASSES SG04

• [BG] Предпазни очила • [RO] Ochelari de protecție • [EL] Γυαλιά Προστασίας • [PT] Óculos de segurança • [IT] Occhiali di sicurezza • [SR] Zaštitne naočare • [SL] Varnostna očala • [BH] Sigurnosne naočare • [RU] Защитные очки • [HR] Zaštitne rukavice • [MK] Сигурносне наочаре

**UV**  
resistant

ADJUSTABLE  
FRAMES  
VERTICAL AND  
HORIZONTAL  
ADJUSTMENT

**IMPACT**  
RESISTANT

**EN166F**

**anti**  
scratch

**2<sup>ND</sup>**  
GENERATION



арт. № КОД/МОДЕЛ ЛЕЩИ РАМКА Баркод  
art. № EM CODE LENSES FRAME Barcode

561405

SG04

Transparent  
polycarbonate

Nylon





## ELECTRONIC EAR MUFFS WITH FM RADIO

- [BG] Електронни външни антифони с FM радио • [RO] Antifoane
- [EL] Ηλεκτρονικά • [PT] Antifones • [IT] Antifone • [SR] Antifoni
- [SL] Antifoni • [BH] Antifoni • [RU] Антифоны • [HR] Antifoni • [MK] антифони



арт. № art. №	КОД/МОДЕЛ EM CODE	Баркод Barcode
561412	EM02	



## EAR MUFFS

- [BG] Външни антифони • [RO] Antifoane • [EL] Ηλεκτρονικά • [PT] Antifones
- [IT] Antifone • [SR] Antifoni spoljašnji • [SL] Antifoni • [BH] Antifoni
- [RU] Антифоны • [HR] Antifoni • [MK] антифони



арт. № art. №	КОД/МОДЕЛ EM CODE	SNR dB	PACK pairs	Баркод Barcode
561411	EM01	25	1	



## REUSABLE EAR PLUGS

- [BG] Вътрешни антифони за многократна употреба • [RO] Antifoane • [EL] Ηλεκτρονικά
- [PT] Antifones • [IT] Antifone • [SR] Antifoni unutrašnji • [SL] Antifoni • [BH] Antifoni
- [RU] Антифоны • [HR] Antifoni • [MK] антифони



арт. № art. №	КОД/МОДЕЛ EM CODE	SNR dB	PACK pairs	Баркод Barcode
561410	EP01	32	50	



13

*РЕКЛАМНИ ПРОДУКТИ*  
*ADVERTISEMENT PRODUCTS*



## PLIERS MULTIFUNCTIONAL

- [BG] Клещи мултифункционални • [RO] Cleste multifunctional • [EL] Πολυεργαλείο Πένσα
- [PT] Alicates multifuncionais • [IT] Pinza multifunzione • [SR] Клешта мултифункционална
- [SL] Kleščice večfunkcionalne • [BH] Klešta multifunkcionalna
- [RU] Плоскогубцы многофункциональные • [HR] Klješta višenamjenski
- [MK] Повеќенаменска Клешти



STAINLESS  
STEEL

арт. № Баркод  
art. № Barcode

549758



## MULTIFUNCTIONAL FOLDING PLIERS

- [BG] Мултифункционални сгъваеми клещи • [RO] Cleste multifunctional pliabil
- [EL] Πολυεργαλείο πτυσσόμενες πένσες
- [PT] Alicates dobrável multifuncional • [IT] Pinza pieghevole multifunzionale
- [SR] Вишенамјенске клијешта за савијање
- [SL] Večnamenske kleščice • [BH] Višenamjenske klješta za savijanje
- [RU] Многофункциональные плоскогубцы
- [HR] Višenamjenski sklopivi klješta
- [MK] Повеќенаменска Клешти на преклопување



STAINLESS  
STEEL

арт. № Баркод  
art. № Barcode

549748



## PLIERS MINI

NEW

- [BG] Клещи мини • [RO] Mini cleste • [EL] Πένσα μίνι • [PT] Alicates mini • [IT] Pinze mini • [SR] Клешта мултифункционална mini
- [SL] Kleščice mini • [BH] Klješta mini • [RU] Плоскогубцы мини • [HR] Pliers mini • [MK] Мини клешти



арт. № Баркод  
art. № Barcode

549793



## LED FLASHLIGHT

NEW

- [BG] Фенер алуминиев • [RO] Lanterna LED • [EL] Φακός • [PT] LED Lanterna • [IT] LED Torcia • [SR] Led lampa
- [SL] LED svetilka • [BH] Svetiljka led • [RU] Алюминиевый фонарь • [MK] Батериска светилка



XPE  
GREE  
R3

3W

WORKING  
TIME  
3.5 h

1x AA  
battery  
included

120m  
WORKING  
DISTANCE

Art. № Баркод  
Art. № Barcode

232502



## BOTTLE OPENER

- [BG] Отварачка • [RO] Deschizator de sticle • [EL] Ανοιχτήρι • [PT] Abridor de garrafa • [IT] Apri bottiglia
- [SR] Отварач • [SL] Žaga lokarica • [BH] Отвараč • [RU] Открывашка • [HR] Отвараč • [MK] Отварач на шишиња

арт. № Баркод  
art. № Barcode

549922

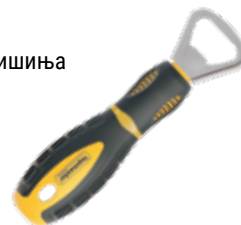

## HAT

- [BG] Шапка • [RO] Șapca • [EL] Καπέλο • [PT] Chapéu • [IT] Cappello • [SR] Kačket
- [SL] Šapka • [BH] Šapka • [RU] Шляпа • [HR] Šešir • [MK] Капа

арт. № Баркод  
art. № Barcode

549731



## POLO SHIRT

- [BG] Тениска • [RO] Tricou • [EL] Κοντομάνικη μπλούζα • [PT] Camiseta • [IT] Maglietta
- [SR] Мајица • [SL] Majica • [BH] Majica • [RU] Футболка • [HR] Majica • [MK] Т-маица

арт. № размер Баркод  
art. № size Barcode

108016

M



549616

L



549617

XL



549618

XXL



549619

XXXL



## JACKET

- [BG] Яке • [RO] Jacheta • [EL] Μπουφάν • [PT] Jaqueta • [IT] Giacca • [SR] Јакна
- [SL] Jakno • [BH] Yake • [RU] Куртка • [HR] Јакна • [MK] Јакна

арт. № размер Баркод  
art. № size Barcode

549709

M



549785

L



549770

XL



549782

XXL



549784

XXXL

**NEW**

## BACKPACK

NEW

- [BG] Раница • [RO] Rucsac • [EL] Σακίδιο • [PT] Mochila • [IT] Zaino • [SR] Руксак • [SL] Nahrbtnik • [BH] Ruksak
- [RU] Рюкзак • [HR] Ruksak • [MK] Ранец



арт. № Баркод  
art. № Barcode

549774



## RACING CHAIR

NEW

- [BG] Стол • [RO] Scaun • [EL] Καρέκλα • [PT] Cadeira • [IT] Sedia • [SR] Stolica
- [SL] Sedež • [BH] Sedište • [RU] Стул • [HR] Kantina • [MK] Стол



арт. № Баркод  
art. № Barcode

549728



- Възможност за регулиране на височината на стола
- Възможност за регулиране на облегалката
- Възможност за регулиране на височината подлакътниците
- Покритие от висококачествени и издържливи материали

## MEASURING TAPE SHELF

- [BG] Стелаж за ролетки • [RO] Stand rulete • [EL] Stand μέτρων • [PT] Fitas de medição de prateleira
- [IT] Nastri di misurazione scaffali • [SR] Stalak za metrove • [SL] Merilni trakovi za polico
- [BH] Merne trake za pole • [RU] Шлифовальные ленты • [HR] Trake za mjerenje polica
- [MK] Полица за метра ленти

арт. № Баркод  
art. № Barcode

549017



art. №	Name	Pcs			
260401	Measuring tape Compact 3 x 16 mm	3	260600	Measuring tape Compact 7.5 m x 25 mm	3
260402	Measuring tape Compact 5 x 19 mm	3	260610	Measuring tape 3 m x 16 mm auto-stop	3
260403	Measuring tape Compact 5 x 25 mm	3	260612	Measuring tape 5 m x 25 mm auto-stop	3
260401	Measuring tape Compact 3 x 16 mm	3	260613	Measuring tape 8 m x 25 mm auto-stop	3
260403	Measuring tape Compact 5 x 25 mm	3			

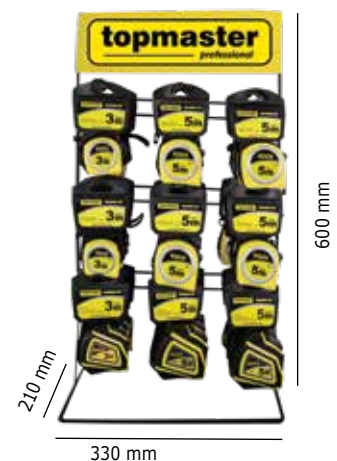

# PVC SHELF

- [BG] Стелаж PVC • [RO] Stand PVC • [EL] Εκθετήριο PVC • [PT] Prateleira • [IT] Mensola • [SR] Полица
- [SL] Polica • [BH] Polica • [RU] Полка • [HR] Polica • [MK] Полица

## ASSEMBLED 1

art. №	Name	Pcs
290908	Adjustable wrench	4
260610	Measuring tape	3
260612	Measuring tape	3
261403	Laser Distance Meter	3
491308	Foam gun	3
370130	All purpose knives	3
371002	Wire cutter	2
370514	Pruning shears	4
370513	Tin cutter straight	3
372301	Hand saw	4
210167	Combination Pliers	4
210166	Diagonal Cutting Pliers	4
211401	Groove Joint Plier	3
320719	Multi scraper	4
491115	Aluminium stapler	3



арт. № Баркод  
art. № Barcode

549014

549778\*

\*Празен стелаж

## ASSEMBLED 2

art. №	Name	Pcs
290908	Adjustable wrench	4
260610	Measuring tape	3
260612	Measuring tape	3
261403	Laser Distance Meter	3
491308	Foam gun	4
370130	All purpose knives	4
371001	Pipe cutter	4
211401	Groove Joint Plier	4
225106	Screwdriver in cardboard box set	4
390122	Torx key short set	4
370514	Pruning shears	4
491113	Staple gun	4



арт. № Баркод  
art. № Barcode

549015

## ASSEMBLED 3

art. №	Name	Pcs
290909	Adjustable wrench	4
250510	Bar Clamp	2
260610	Measuring tape	3
260611	Measuring tape	3
269909	Laser measuring tape	3
370130	All purpose knives	3
371002	Wire cutter	2
372301	Hand saw	3
210167	Combination Pliers	4
210166	Diagonal Cutting Pliers	4
211401	Groove Joint Plier	4
235124	Com. spanners press set	2
390909	Tools set	2
491155	Hand riveter	3
379601	Grout saw	4



арт. № Баркод  
art. № Barcode

549016

# SHELF FOR LEVELS

- [BG] Стелаж за нивелири • [RO] Stand nivele • [EL] Stand για Αλφάδια
- [PT] Prateleira para niveis • [IT] Mensola per livelli • [SR] Полица за libele
- [SL] Polica za ravni • [BH] Polica za niveo • [RU] Полка для уровней
- [HR] Polica za razine • [MK] Полица за либели

art. №	Name	Pcs
270307	Magnet Spirit level 400 mm	6
270308	Magnet Spirit level 600 mm	6
270309	Magnet Spirit level 800 mm	6
270310	Magnet Spirit level 1000 mm	6
270311	Magnet Spirit level 1200 mm	6
270312	Magnet Spirit level 1500 mm	3
270313	Magnet Spirit level 1800 mm	3



арт. № Баркод  
art. № Barcode

549013

# SHELF FOR SCREEDING LEVELS

- [BG] Стелаж за мастари • [RO] Stand dreptare
- [EL] Stand για Πήχες με αλφάδι • [PT] Prateleira para niveis especiais
- [IT] Mensola per livelli speciali • [SR] Полица за специјалне libele
- [SL] Polica za posebne nivoje • [BH] Polica za specijalne niveo
- [RU] Полка для специальных уровней • [HR] Polica za posebne razine
- [MK] Полица за зидарски летви

art. №	Name	Pcs
321708	Screeding level 1500 mm	4
321709	Screeding level 2000 mm	5
321710	Screeding level 2500 mm	4
321711	Screeding level 3000 mm	3
321713	Screeding level 1000 mm	2
321714	Screeding level 1500 mm	3
321715	Screeding level 2000 mm	5
321716	Screeding level 2500 mm	3
321717	Screeding level 3000 mm	2
321701	Screeding level 1000 mm	2
321702	Screeding level 1500 mm	4
321703	Screeding level 2000 mm	5
321704	Screeding level 2500 mm	4
321705	Screeding level 3000 mm	3
321719	Screeding level h 1500 mm	2
321720	Screeding level h 2000 mm	2
321721	Screeding level h 2500 mm	2



арт. № Баркод  
art. № Barcode

549012



## LASER LEVEL 1X3D TMP

- [BG] Лазерен нивелир • [RO] Nivelă laser • [EL] Επίπεδο λέιζερ • [PT] Nível de laser
- [IT] Livello laser • [SR] Nivo lasera • [SL] Raven laserja • [BH] Nivo lasera
- [RU] Лазерный Уровень • [MK] Ласерски ниво

арт. №  
art. №

Баркод  
Barcode

279910





## STUD FINDER DIGITAL TMP12M

- [BG] Детектор дигитален • [RO] Detector digital metal/lemn + Nivelă
- [EL] Ανιχνευτής μετάλλων-ρεύματος-ξύλου & αλφάδι
- [PT] Detetor madeira, metal, electricidade
- [IT] Rilevatore digitale metallo/legno + livella • [SR] Digitalni detektor
- [SL] Digitalni detektor • [BH] Metal detektor • [RU] Детектор
- [MK] Digitalen detektor

арт. №  
art. №

Баркод  
Barcode

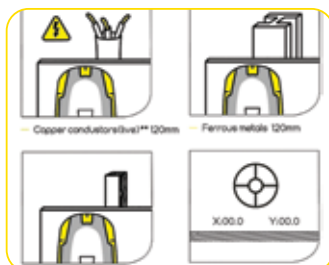
261401

## SKIMMING BLADES

- [BG] Ножове за шпакловане • [RO] Lama de gletuire
- [EL] Σπάτουλα Στοκαρίσματος με Inox Λάμα
- [PT] Facas de reboco
- [IT] Coltelli da intonaco • [SR] Sečiva za skidanje
- [SL] Skimming rezila • [BH] Sečiva za skidanje • [RU] Штукатурные ножи
- [MK] Ножеви за гипсирање

арт. №  
art. №

Баркод  
Barcode

320141



600 mm

320142



800 mm

320143



1000 mm



## SKIMMING BLADE HANDLE ADAPTER

- [BG] Щипка за нож за шпакловане • [RO] Adaptor maner pentru lama de gletuire
- [EL] Λαβή για Σπάτουλα Στοκαρίσματος • [PT] Adaptador de manípulo
- [IT] Adattatore per maniglia • [SR] Adaptor regulatora
- [SL] Ročaj adapter • [BH] Adaptor regulatora • [RU] Адаптер ручки
- [MK] Адаптор за рачка

арт. №  
art. №

Баркод  
Barcode

320147



## ALUMINUM TELESCOPIC SKIMMING BLADE HANDLE

- [BG] Телескопична дръжка • [RO] Maner telescopic aluminiu pentru lama de gletuire
- [EL] Κοντάρι Αλουμινίου Τηλεσκοπικό για Σπάτουλα Στοκαρίσματος
- [PT] Pega telescópica • [IT] Manico telescopico • [SR] Teleskopska drška
- [SL] Teleskopski ročaj • [BH] Teleskopska drška • [RU] Телескопическая ручка
- [MK] Телескопска рачка

COMING  
SOON

арт. №  
art. №

Баркод  
Barcode

320148



AL

116-200  
CM

## TILE LEVELING SYSTEM - SET

- [BG] Система за нивелиране на плочки • [RO] Sistem nivelare placi ceramice
- [EL] Σετ Σύστημα Αλφαδοποίησης • [PT] Sistema de nivelamento de telhas
- [IT] Sistema di livellamento delle piastrelle • [SR] Sistem za izjednačavanje pločica
- [SL] Sistem za izravnanje ploščic • [BH] Sistem za izjednačavanje pločica
- [RU] Система выравнивания плитки • [MK] Систем за израмнување на плочки

арт. №  
art. №

Баркод  
Barcode

329918



329918C

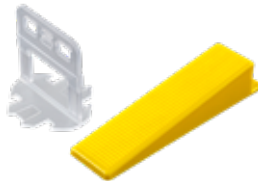

## IMPACT WRENCH 1"

- [BG] Гайковерт пневматичен ударен • [RO] Cheie cu impact pneumatica • [EL] Αερόκλειδο
- [PT] Chave de impacto pneumática • [IT] Chiave ad impatto • [SR] Zavrtač pneumatski
- [SL] Udarni vijčnik • [BH] Zračni udarni ključ • [RU] Ударный Пневмогайковёрт
- [MK] Пневматски чекан

арт. №  
art. №

Баркод  
Barcode

344106



2400  
NM

TWIN  
HAMMER

3+3  
MODES



## IMPACT WRENCH 1/2" MINI

- [BG] Гайковерт пневматичен ударен • [RO] Cheie cu impact pneumatica • [EL] Αερόκλειδο
- [PT] Chave de impacto pneumática • [IT] Chiave ad impatto • [SR] Zavrtač pneumatski
- [SL] Udarni vijčnik • [BH] Zračni udarni ključ • [RU] Ударный Пневмогайковёрт
- [MK] Пневматски чекан

арт. №  
art. №

Баркод  
Barcode

344107



1200  
NM

TWIN  
HAMMER

3+1  
MODES

TMP66M





2022-2024

topmaster

Art. № 108026



3 800972 019416

**Euromaster Import - Export Ltd**  
Bulgaria, 1231 Sofia  
246, "Lomsko shose" blvd.,  
tel.: +359 87 530 0101  
[www.euromasterbg.com](http://www.euromasterbg.com)



 0700 44 155

[info@euromasterbg.com](mailto:info@euromasterbg.com)  
[www.topmaster.bg](http://www.topmaster.bg)