

RAIDER[®]

CATALOGUE 2026



RAIDER[®]
Power Tools

RAIDER[®]
Pro

R20 System

Марката Raider през годините

Пред Вас е новият каталог на Raider 2026 год., където можете да намерите цялостни решения за Вашия бизнес сред богатия избор от акумулаторни, електрически, бензинови и пневматични машини и консумативи за тях. Този каталог включва над 2700 артикули.

Марката Raider е собствен бранд на Евромасер Импорт - Експорт ООД, познат и утвърден на българския пазар повече от 35 години.

Разнообразието на машини в този бранд, покрива практически целия диапазон дейности - строителство, дървообработване, металообработване, авто и градинска техника. Предлагаме и пълна гама съответни консумативи, съвместими не само с машините с бранд Raider. След успешния старт през 2000 година, марката Raider не е изменила на визията и мисията си, базирани на потребностите и очакванията на потребителите. Съобразно тях сме обновили асортимента си, достигайки по-високо технологично равнище.

Ценностите, на които се гради успехът ни са:

- Технологично качество, отговарящо на високи професионални изисквания, на разумна, достъпна и конкурентна цена;
- Качество, на което клиентите се доверяват;
- Стабилни, открити и честни взаимоотношения с бизнес партньори, производители и дистрибутори;
- Професионална и лична отговорност за поетите рискове и взетите решения.

С новите машини и усъвършенстването на моделите, спечелили Вашето доверие с доказаното си качество, ние добавяме допълнителни ползи и предимства и адаптираме продуктите към пазарната среда, за да продължава Raider да бъде най-доброто предложение при избор на машини за интензивна работа при професионални условия.

След утвърждаването на продуктите в България, Raider успешно разширява дистрибуторската си мрежа и пазарния си дял в редица страни от Централна и Източна Европа.

Raider Brand over the years

Dear Customers and Partners,

Now you have our new Raider product catalogue for 2026, where you can find complete solutions for your business among the wide selection of electric, gasoline and pneumatic equipment and consumables. This catalog includes more than 2700 articles

Raider brand is Euromaster Import - Export Ltd. own brand known and recognized on Bulgarian market more than 35 years. The variety of instruments with this brand covers practically the whole range of activities - construction, woodworking, metalworking, auto- and garden equipment. The variety of machines with this brand covers practically the whole range of activities - construction, woodworking, metalworking,

auto- and garden equipment. We offer also a full range of related accessories, compatible not only with Raider brand machines.

After the successful launch in 2000, Raider brand has not altered its vision and mission based on the needs and expectations of consumers; we have upgraded its range accordingly, reaching a higher level of technology. The values upon which our success was built are:

- Technological quality meeting the highest professional requirements at a reasonable, affordable and competitive price;
- Quality that customers trust;
- Stable, open and honest relationships with business partners, manufacturers and distributors;
- Professional and personal responsibility for the taken risks and decisions.

With the new machines and improvement of models, which earn your trust with proven quality, we add additional benefits and advantages

and adapt our products to the market environment to keep being RAIDER best deal when choosing a machine for intensive use in a professional environment.

With the recognition of the products in Bulgaria, Raider has been successfully expanding its market share and developing its distribution

network in several countries of Central and Eastern Europe.

R20 SYSTEM STARTER KIT & CHARGER

RDP-R20 SYSTEM

• [BG] R20 Комплект батерия и зарядно • [RO] R20 Set incarcator si acumulator



ART.NO.	BARCODE
032133	3800972032057

R20 SYSTEM STARTER KIT & CHARGER

RDP-R20 SYSTEM

• [BG] R20 Комплект батерия и зарядно • [RO] R20 Set incarcator si acumulator



ART.NO.	BARCODE
032120	3800123168307

R20 SYSTEM STARTER KIT & CHARGER

RDP-R20 SYSTEM

• [BG] R20 Комплект батерия и зарядно • [RO] R20 Set incarcator si acumulator



ART.NO.	BARCODE
131167	3800972028616

R20 BATTERY

RDP-R20 SYSTEM

• [BG] R20 Батерия • [RO] R20 Acumulator



ART.NO.	BARCODE
131110	3800123168284

R20 BATTERY

RDP-R20 SYSTEM

• [BG] R20 Батерия • [RO] R20 Acumulator



ART.NO.	BARCODE
131152	3800972005310

R20 BATTERY

RDP-R20 SYSTEM

• [BG] R20 Батерия • [RO] R20 Acumulator



ART.NO.	BARCODE
131175	3800972040571

R20 BATTERY

RDP-R20 SYSTEM

• [BG] R20 Батерия • [RO] R20 Acumulator

1x4Ah



ART.NO.	BARCODE
131153	3800972005327

R20 BATTERY

RDP-R20 SYSTEM

• [BG] R20 Батерия • [RO] R20 Acumulator

2x4Ah



ART.NO.	BARCODE
131176	3800972040588

R20 BATTERY

RDP-R20 SYSTEM

• [BG] R20 Батерия • [RO] R20 Acumulator

1x5Ah



ART.NO.	BARCODE
131172	3800972034075

R20 BATTERY

RDP-R20 SYSTEM

• [BG] R20 Батерия • [RO] R20 Acumulator

1x6Ah



ART.NO.	BARCODE
131161	3800972014718

R20 BATTERY

RDP-R20 SYSTEM

• [BG] R20 Батерия • [RO] R20 Acumulator

1x8Ah



ART.NO.	BARCODE
131170	3800972030688

R20 BATTERY

RDP-R20 SYSTEM

• [BG] R20 Батерия • [RO] R20 Acumulator

1x8Ah



ART.NO.	BARCODE
131164	3800972025073

R20 BATTERY

RDP-R20 SYSTEM

• [BG] R20 Батерия • [RO] R20 Acumulator

1x12Ah



ART.NO.	BARCODE
131174	3800972040519

R20 CHARGER

RDP-R20 SYSTEM

• [BG] R20 Зарядно • [RO] R20 Incarcator



ART.NO.	BARCODE
039709	3800972019775

R20 CHARGER

RDP-R20 SYSTEM

• [BG] R20 Зарядно • [RO] R20 Incarcator



ART.NO.	BARCODE
039703	3800123168291

R20 RAPID CHARGER

RDP-R20 SYSTEM

• [BG] R20 Бързо зарядно • [RO] R20 Incarcator rapid



ART.NO.	BARCODE
039704	3800972005334

R20 RAPID CHARGER

RDP-R20 SYSTEM

• [BG] R20 Бързо зарядно • [RO] R20 Incarcator rapid



ART.NO.	BARCODE
039720	3800972040564

R20 DUAL CHARGER

RDP-R20 SYSTEM

• [BG] R20 Зарядно двойно • [RO] R20 Incarcator dual



ART.NO.	BARCODE
039717	3800972029873

R20 DUAL CHARGER

RDP-R20 SYSTEM

• [BG] R20 Зарядно двойно • [RO] R20 Incarcator dual



ART.NO.	BARCODE
039707	3800972014459

R20 RAPID CHARGER

RDP-R20 SYSTEM

• [BG] R20 Бързо зарядно • [RO] R20 Incarcator rapid



ART.NO.	BARCODE
039713	3800972025080

R20 CONNECTOR PARKSIDE TO BATTERY RDP-R20 SYSTEM

RDP-R20 SYSTEM

• [BG] R20 Конектор Parkside за батерии • [RO] R20 conector Parkside la acumulator 20V Raider



ART.NO.	BARCODE
039721	3800972047266

R20 CORDLESS HAMMER DRILL-DRIVER

RDP-PCD20 SOLO

• [BG] R20 Бормашина ударна • [RO] R20 Masina de gaurit



ART.NO.	BARCODE
030252	3800972036130

R20 CORDLESS DRILL & BRUSHLESS IMPACT WRENCH

RDP-PCD20&PBIW20 SET

• [BG] R20 Бормашина и безчетков гайковерт
• [RO] R20 Masina insurubat cu impact



ART.NO.	BARCODE
030253	3800972036147

R20 BRUSHLESS DRILL CORDLESS

RDP-KCD20 SOLO

• [BG] R20 Бормашина • [RO] R20 Masina de gaurit



ART.NO.	BARCODE
030234	3800972029279

R20 BRUSHLESS DRILL CORDLESS

RDP-SPCD20 SET

• [BG] R20 Бормашина • [RO] R20 Masina de gaurit



ART.NO. 030227
 BARCODE 3800972025516

R20 CORDLESS HAMMER DRILL-DRIVER

RDP-PCDI20 SET

• [BG] R20 Бормашина ударна • [RO] R20 Masina de gaurit si insurubat

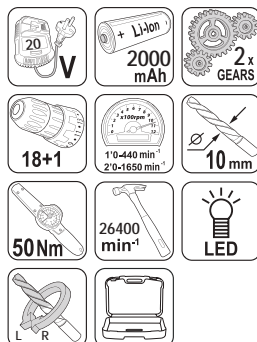

ART.NO. 030236
 BARCODE 3800972030367

R20 BRUSHLESS CORDLESS DRILL

RDP-SPCD20 SET

• [BG] R20 Бормашина • [RO] R20 Masina de gaurit



ART.NO. 030228
 BARCODE 3800972025523

R20 BRUSHLESS CORDLESS DRILL

RDP-BCD20 SOLO

• [BG] R20 Бормашина безчеткова • [RO] R20 Masina de gaurit si insurubat



BRUSHLESS

ART.NO. 030232
 BARCODE 3800972029002

R20 BRUSHLESS CORDLESS DRILL

RDP-YBD20 SOLO

• [BG] R20 Бормашина безчеткова • [RO] R20 Masina de gaurit si insurubat



BRUSHLESS

ART.NO. 030243
 BARCODE 3800972032293

R20 BRUSHLESS CORDLESS DRILL

RDP-PBCD20 SET

• [BG] R20 Бормашина безчеткова • [RO] R20 Masina de gaurit si insurubat



BRUSHLESS

ART.NO. 030231
 BARCODE 3800972026858

R20 BRUSHLESS CORDLESS DRILL

RDP-PBCDI20 SOLO

• [BG] R20 Бормашина безчеткова • [RO] R20 Masina de gaurit si insurubat



BRUSHLESS

ART.NO. BARCODE
030237 3800972030374

R20 BRUSHLESS CORDLESS DRILL

RDP-PBD20 SET

• [BG] R20 Бормашина безчеткова • [RO] R20 Masina de gaurit si insurubat



BRUSHLESS

ART.NO. BARCODE
030260 3800972039964

R20 CORDLESS DRILL & ANGLE GRINDER

RDP-PBCDI20&SPAG20 SET

• [BG] R20 Бормашина безчеткова & Ђглошлайф
• [RO] R20 Bormasina si polizor unghiular



BRUSHLESS

ART.NO. BARCODE
030238 3800972030381

R20 CORDLESS DRILL ANGLE GRINDER IMPACT WRENCH

RDP-PBCDI20&SPAG20&PBIW20 SET

• [BG] R20 Бормашина Ђглошлайф Гайковер
• [RO] R20 Set Masina de gaurit BL, polizor & cheie cu impact

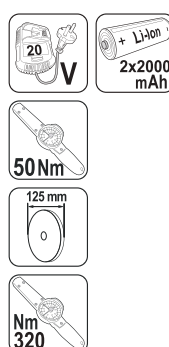

ART.NO. BARCODE
030255 3800972036536

R20 BRUSHLESS CORDLESS HAMMER DRILL-DRIVER

RDP-YBID20 SOLO

• [BG] R20 Бормашина ударна безчеткова
• [RO] R20 Masina de gaurit cu percutie

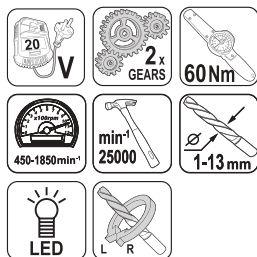

BRUSHLESS

ART.NO. BARCODE
030244 3800972032309

R20 BRUSHLESS CORDLESS HAMMER DRILL-DRIVER

RDP-YBID20 SET

• [BG] R20 Бормашина ударна безчеткова
• [RO] R20 Masina de gaurit cu percutie



ART.NO. BARCODE
030263 3800972040472

R20 BRUSHLESS CORDLESS HAMMER DRILL-DRIVER

RDP-8PBID20

- [BG] R20 Бормашина ударна безчеткова
- [RO] R20 Masina de gaurit cu percutie

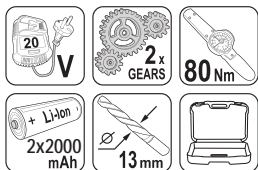

BRUSHLESS

ART.NO. BARCODE
030261 3800972039971

R20 BRUSHLESS CORDLESS HAMMER DRILL-DRIVER

RDP-10PBID20

- [BG] R20 Бормашина ударна безчеткова
- [RO] R20 Masina de gaurit cu percutie

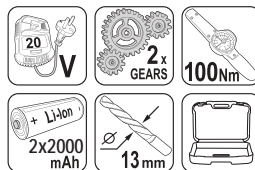

BRUSHLESS

ART.NO. BARCODE
030262 3800972039988

R20 BRUSHLESS CORDLESS HAMMER DRILL-DRIVER

RDP-PBID20 SOLO

- [BG] R20 Бормашина ударна безчеткова
- [RO] R20 Masina de gaurit cu percutie



BRUSHLESS

ART.NO. BARCODE
030254 3800972036338

R20 BRUSHLESS DRYWALL SCREWDRIVER

RDP-BDS20 SOLO

- [BG] R20 Винтоверт за гипсокартон безчетков
- [RO] R20 Surubelnita electrica gips-carton

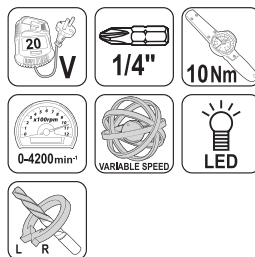

BRUSHLESS

ART.NO. BARCODE
030187 3800972032453

R20 BRUSHLESS CORDLESS DRYWALL SCREWDRIVER

RDP-SBES20 SOLO

- [BG] R20 Винтоверт за гипсокартон безчетков
- [RO] R20 Surubelnita electrica gips-carton



BRUSHLESS

ART.NO. BARCODE
030159 3800972018464

R20 CORDLESS HEX IMPACT DRIVER

RDP-KHID20 SOLO

- [BG] R20 Винтоверт ударен
- [RO] R20 Masina insurubat cu impact



ART.NO. BARCODE
030172 3800972030589

R20 CORDLESS HEX IMPACT DRIVER

RDP-KHID20 SET

• [BG] R20 Винтоверт ударен • [RO] R20 Masina insurubat cu impact

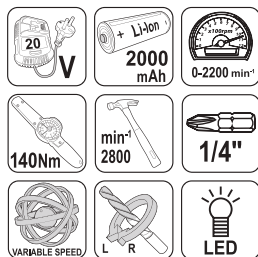

ART.NO. BARCODE
030177 3800972030732

R20 CORDLESS HEX IMPACT DRIVER

RDP-SHID20 SOLO

• [BG] R20 Винтоверт ударен • [RO] R20 Masina insurubat cu impact

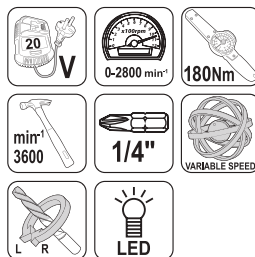

ART.NO. BARCODE
030132 3800123168192

R20 BRUSHLESS CORDLESS HEX IMPACT DRIVER

RDP-BCHID20 SOLO

• [BG] R20 Винтоверт ударен безчетков • [RO] R20 Masina insurubat cu impact



BRUSHLESS

ART.NO. BARCODE
030142 3800972028975

R20 BRUSHLESS HEX IMPACT DRIVER

RDP-BHID20 SOLO

• [BG] R20 Винтоверт ударен безчетков • [RO] R20 Masina insurubat cu impact

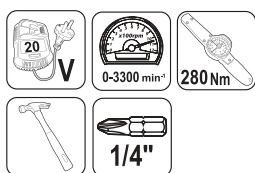

BRUSHLESS

ART.NO. BARCODE
030346 3800972045064

R20 BRUSHLESS IMPACT WRENCH

RDP-S35BBIW20 SOLO

• [BG] R20 Гайковерт безчетков • [RO] R20 Masina insurubat cu impact

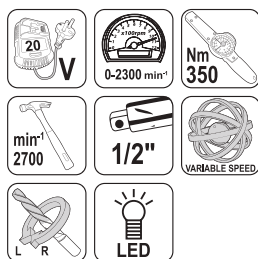

BRUSHLESS

ART.NO. BARCODE
030195 3800972035140

R20 BRUSHLESS IMPACT WRENCH

RDP-S55BBIW20 SOLO

• [BG] R20 Гайковерт безчетков • [RO] R20 Masina insurubat cu impact

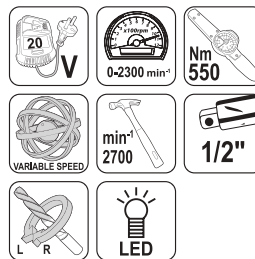

BRUSHLESS

ART.NO. BARCODE
030196 3800972035157

R20 BRUSHLESS IMPACT WRENCH

RDP-90BBIW20 SOLO

• [BG] R20 Гайковерт безчетков • [RO] R20 Masina insurubat cu impact

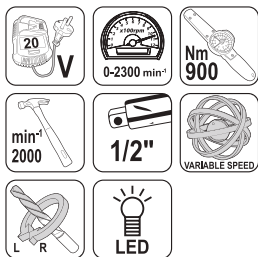

BRUSHLESS

ART.NO. BARCODE
030197 3800972035164

R20 BRUSHLESS IMPACT WRENCH

RDP-YBIW20 SOLO

• [BG] R20 Гайковерт безчетков • [RO] R20 Masina insurubat cu impact

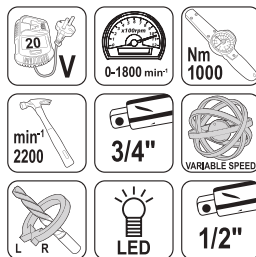

BRUSHLESS

ART.NO. BARCODE
030245 3800972032316

R20 BRUSHLESS IMPACT WRENCH

RDP-12BIW20 SET

• [BG] R20 Гайковерт безчетков • [RO] R20 Masina insurubat cu impact

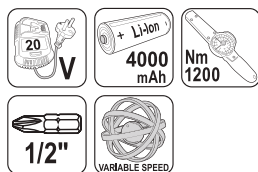

BRUSHLESS

ART.NO. BARCODE
030343 3800972045033

R20 BRUSHLESS IMPACT WRENCH

RDP-18BIW20 SET

• [BG] R20 Гайковерт безчетков • [RO] R20 Masina insurubat cu impact

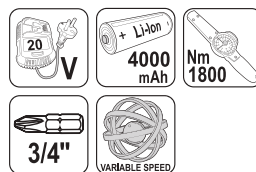

BRUSHLESS

ART.NO. BARCODE
030344 3800972045040

R20 BRUSHLESS IMPACT WRENCH

RDP-BBIW20 SOLO

• [BG] R20 Гайковерт безчетков • [RO] R20 Masina insurubat cu impact

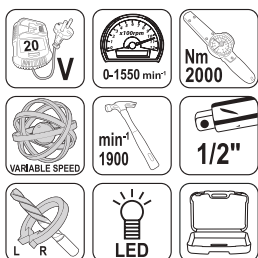

BRUSHLESS

ART.NO. BARCODE
030194 3800972035133

R20 BRUSHLESS IMPACT WRENCH

RDP-23BBIW20 SOLO

• [BG] R20 Гайковерт безчетков • [RO] R20 Masina insurubat cu impact



BRUSHLESS

ART.NO. BARCODE
030259 3800972039957

R20 CORDLESS RATCHET WRENCH

RDP-KRW20 SOLO

• [BG] R20 Тресчотка • [RO] R20 Cheie cu clichet

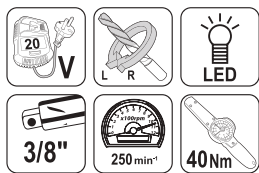

ART.NO. BARCODE
030239 3800972030596

R20 CORDLESS RATCHET WRENCH

RDP-KRW20 SET

• [BG] R20 Тресчотка • [RO] R20 Cheie cu clichet

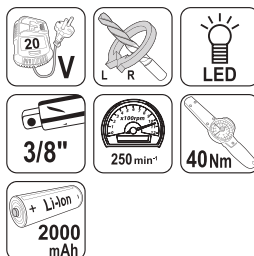

ART.NO. BARCODE
030241 3800972030749

R20 CORDLESS ROTARY HAMMER

RDP-SRH20 SOLO

• [BG] R20 Перфоратор • [RO] R20 Ciocan rotopercurtor

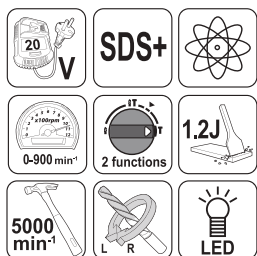

ART.NO. BARCODE
030135 3800123168239

R20 BRUSHLESS ROTARY HAMMER

RDP-BRH20 SOLO

• [BG] R20 Перфоратор безчетков • [RO] R20 Ciocan rotopercurtor



BRUSHLESS
4 FUNCTION

ART.NO. BARCODE
030183 3800972031678

R20 BRUSHLESS ROTARY HAMMER

RDP-BRH20 SET

• [BG] R20 Перфоратор безчетков • [RO] R20 Ciocan rotopercurtor

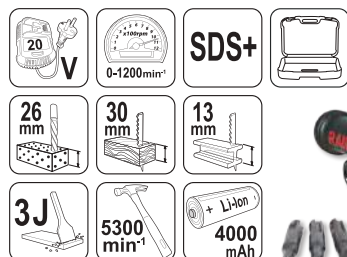

BRUSHLESS
4 FUNCTION

ART.NO. BARCODE
030202 3800972039940

R20 BRUSHLESS ROTARY HAMMER

RDP-BBRH20 SOLO

• [BG] R20 Перфоратор безчетков • [RO] R20 Ciocan rotopercurtor

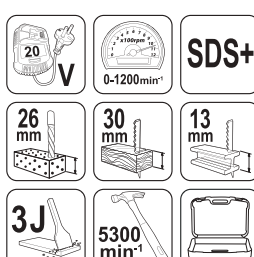

BRUSHLESS
4 FUNCTION

ART.NO. BARCODE
030193 3800972035119

R20 BRUSHLESS ROTARY HAMMER

RDP-YBRH20 SOLO

• [BG] R20 Перфоратор безщетков • [RO] R20 Ciocan rotopercurator

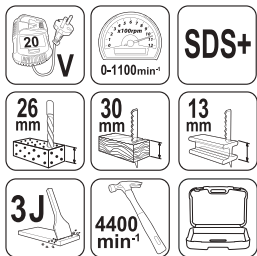

BRUSHLESS

2 FUNCTION

ART.NO. BARCODE
030192 3800972034570

R20 BRUSHLESS ROTARY HAMMER

RDP-BMBRH20 SOLO

• [BG] R20 Перфоратор безщетков • [RO] R20 Ciocan rotopercurator

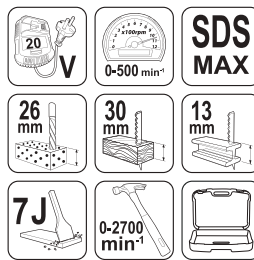

BRUSHLESS

4 FUNCTION

ART.NO. BARCODE
030200 3800972038219

R20 BRUSHLESS ROTARY HAMMER

RDP-RH20 SOLO

• [BG] R20 Перфоратор безщетков • [RO] R20 Ciocan rotopercurator



BRUSHLESS

4 FUNCTION

ART.NO. BARCODE
030169 3800972028999

R20 BRUSHLESS ROTARY HAMMER

RDP-BBR20 SET

• [BG] R20 Перфоратор безщетков • [RO] R20 Ciocan rotopercurator

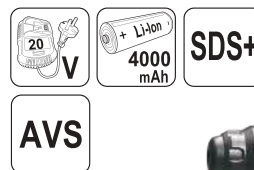

BRUSHLESS

4 FUNCTION

ART.NO. BARCODE
030342 3800972045026

R20 CORDLESS HANDLE MIXER

RDP-SHM20 SOLO

• [BG] R20 Миксер • [RO] R20 Mixer

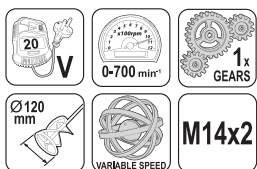

ART.NO. BARCODE
030152 3800972014282

R20 CORDLESS HANDLE MIXER

RDP-HHM20 SOLO

• [BG] R20 Миксер • [RO] R20 Mixer

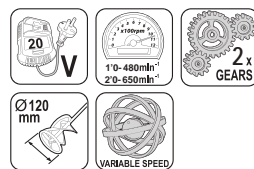

ART.NO. BARCODE
030267 3800972040595

R20 TILE VIBRATOR LEVELING MACHINE

RDP-TV20 SOLO

• [BG] R20 Вибратор за плочки • [RO] R20 Ventuza cu vibratii

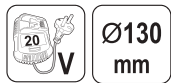

Ø130
mm



ART.NO. BARCODE
030268 3800972040601

R20 CORDLESS VACUUM SUCTION CUP

RDP-CVSC20 SOLO

• [BG] R20 Вакуум за плочки • [RO] R20 Ventuza

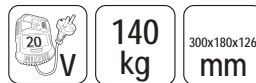

140
kg

300x180x126
mm



ART.NO. BARCODE
030269 3800972040618

R20 CORDLESS ANGLE GRINDER

RDP-SPAG20 SOLO

• [BG] R20 Ъглошлайф • [RO] R20 Polizor unghiular

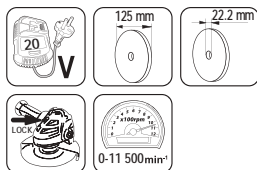

125 mm

22.2 mm

0-11 500min⁻¹



ART.NO. BARCODE
030233 3800972029088

R20 CORDLESS ANGLE GRINDER

RDP-SPAG20 SET

• [BG] R20 Ъглошлайф • [RO] R20 Polizor unghiular



125 mm

22.3 mm

+ Li-Ion
4000
mAh

CHARGING
TIME 1 h

0-11 500min⁻¹



ART.NO. BARCODE
030235 3800972030350

R20 CORDLESS ANGLE GRINDER

RDP-SPAG20 SET

• [BG] R20 Ъглошлайф • [RO] R20 Polizor unghiular

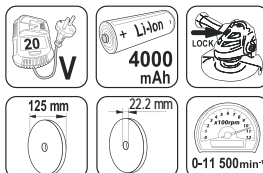

+ Li-Ion
4000
mAh

LOCK

125 mm

22.2 mm

0-11 500min⁻¹



ART.NO. BARCODE
030251 3800972034587

R20 CORDLESS ANGLE GRINDER

RDP-KBAG20 SOLO

• [BG] R20 Ъглошлайф • [RO] R20 Polizor unghiular

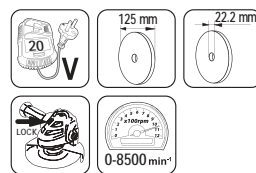

125 mm

22.2 mm

LOCK

0-8500min⁻¹



ART.NO. BARCODE
030240 3800972030602

R20 CORDLESS ANGLE GRINDER

RDP-KBAG20 SET

• [BG] R20 Ъглошлайф • [RO] R20 Polizor unghiular

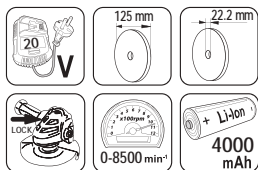

ART.NO. BARCODE
030242 3800972030756

R20 CORDLESS ANGLE GRINDER

RDP-YAG20 SOLO

• [BG] R20 Ъглошлайф • [RO] R20 Polizor unghiular

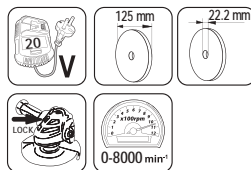

ART.NO. BARCODE
030246 3800972032323

R20 CORDLESS ANGLE GRINDER

RDP-YAG20 SET

• [BG] R20 Ъглошлайф • [RO] R20 Polizor unghiular

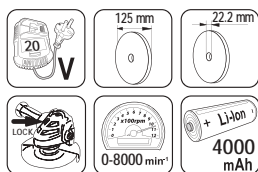

ART.NO. BARCODE
030250 3800972034556

R20 BRUSHLESS CORDLESS ANGLE GRINDER

RDP-DBAG20 SOLO

• [BG] R20 Ъглошлайф • [RO] R20 Polizor unghiular brushless

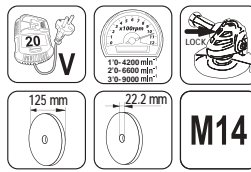

BRUSHLESS

ART.NO. BARCODE
030270 3800972041233

R20 BRUSHLESS CORDLESS ANGLE GRINDER

RDP-PBAG20 SOLO

• [BG] R20 Ъглошлайф • [RO] R20 Polizor unghiular brushless



BRUSHLESS

ART.NO. BARCODE
030229 3800972026575

R20 BRUSHLESS CORDLESS ANGLE GRINDER

RDP-PBAG20 SET

• [BG] R20 Ъглошлайф • [RO] R20 Polizor unghiular brushless



BRUSHLESS

ART.NO. BARCODE
030230 3800972026582

R20 BRUSHLESS ANGLE GRINDER

RDP-DBAG20 SOLO

• [BG] R20 Ъглошлайф • [RO] R20 Polizor unghiular brushless

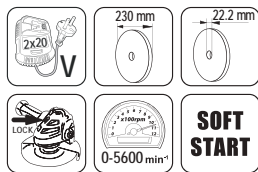

BRUSHLESS

ART.NO. BARCODE
030257 3800972038325

R20 BISCUIT JOINTER

RDP-CBJ20 SOLO

• [BG] R20 Бисквит машина • [RO] R20 Freza biscuiti



ART.NO. BARCODE
030256 3800972038226

R20 CORDLESS JIG SAW

RDP-YJS20 SOLO

• [BG] R20 Прободен трион • [RO] R20 Fierastrau pendular

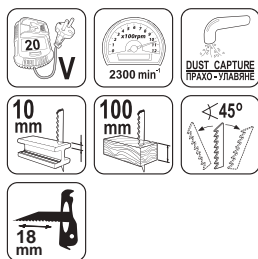

QUICK CHANGE

ART.NO. BARCODE
030247 3800972032330

R20 CORDLESS JIG SAW

RDP-KJS20 SOLO

• [BG] R20 Прободен трион • [RO] R20 Fierastrau pendular



QUICK CHANGE

ART.NO. BARCODE
030173 3800972030619

R20 CORDLESS JIG SAW

RDP-KJS20 SET

• [BG] R20 Прободен трион • [RO] R20 Fierastrau pendular

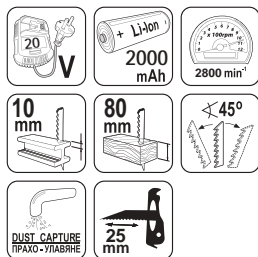

QUICK CHANGE

ART.NO. BARCODE
030178 3800972030763

R20 CORDLESS JIG SAW

RDP-SJS20 SOLO

• [BG] R20 Прободен трион • [RO] R20 Fierastrau pendular

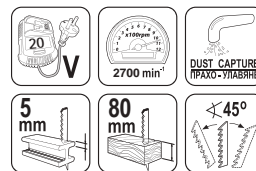

ART.NO. BARCODE
030137 3800123168246

R20 CORDLESS JIG SAW

RDP-SJS20 SET

• [BG] R20 Прободен трион • [RO] R20 Fierastrau pendular

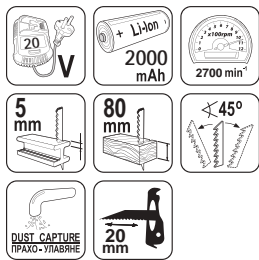

QUICK CHANGE

ART.NO.	BARCODE
030210	3800972005365

R20 CORDLESS RECIPROCATING SAW

RDP-KRS20 SOLO

• [BG] R20 Трион саблен • [RO] R20 Fierastrau sabie

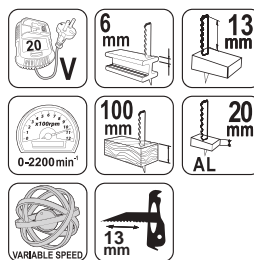

QUICK CHANGE

ART.NO.	BARCODE
030176	3800972030640

R20 CORDLESS RECIPROCATING SAW

RDP-KRS20 SET

• [BG] R20 Трион саблен • [RO] R20 Fierastrau sabie

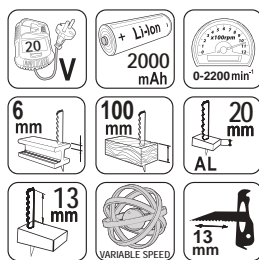

QUICK CHANGE

ART.NO.	BARCODE
030181	3800972030794

R20 CORDLESS RECIPROCATING SAW

RDP-PRS20 GARDEN SOLO

• [BG] R20 Трион саблен • [RO] R20 Fierastrau sabie

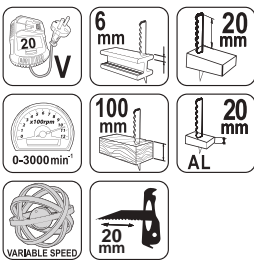

QUICK CHANGE

ART.NO.	BARCODE
050205	3800972026568

R20 CORDLESS RECIPROCATING SAW

RDP-YRS20 SOLO

• [BG] R20 Трион саблен • [RO] R20 Fierastrau sabie

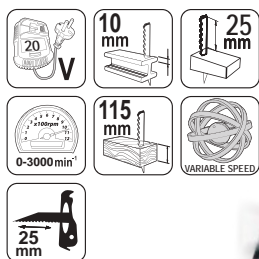

ART.NO.	BARCODE
030258	3800972038363

R20 CORDLESS RECIPROCATING SAW

RDP-SRS20 SOLO

• [BG] R20 Трион саблен • [RO] R20 Fierastrau sabie

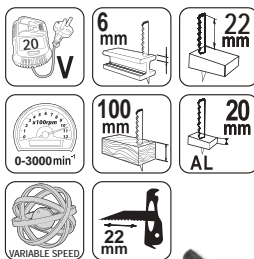

QUICK CHANGE

ART.NO.	BARCODE
030138	3800123168260

R20 BRUSHLESS RECIPROCATING SAW

RDP-DBRS20 SOLO

• [BG] R20 Трион саблен безчетков • [RO] R20 Fierastrau sabie



BRUSHLESS

QUICK CHANGE

ART.NO.	BARCODE
050204	3800972023680

R20 CORDLESS CIRCULAR SAW

RDP-YCS20 SOLO

• [BG] R20 Циркуляр • [RO] R20 Fierastrau circular de mana

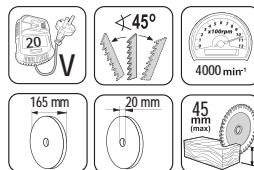

ART.NO.	BARCODE
030248	3800972032347

R20 CORDLESS CIRCULAR SAW

RDP-KCS20 SOLO

• [BG] R20 Циркуляр • [RO] R20 Fierastrau circular de mana

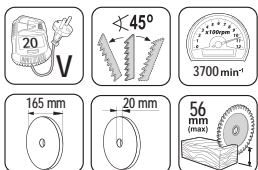

ART.NO.	BARCODE
030174	3800972030626

R20 CORDLESS CIRCULAR SAW

RDP-KCS20 SET

• [BG] R20 Циркуляр • [RO] R20 Fierastrau circular de mana

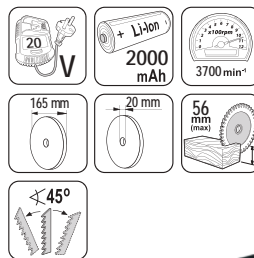

ART.NO.	BARCODE
030179	3800972030770

R20 CORDLESS CIRCULAR SAW

RDP-SCS20 SOLO

• [BG] R20 Циркуляр • [RO] R20 Fierastrau circular de mana

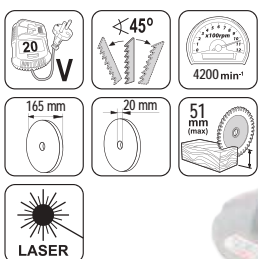

ART.NO.	BARCODE
030139	3800123168208

CIRCULAR SAW BLADE TUNGSTEN CARBIDE TIPPED

RDP

• [BG] Диск за циркуляр • [RO] Disc circular pentru lemn

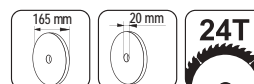

ART.NO.	BARCODE
163143	3800972005396

R20 CORDLESS MITRE SAW

RDP-SMS20 SET

• [BG] R20 Циркулярен настолен • [RO] R20 Fierastrau circular semi-stationar

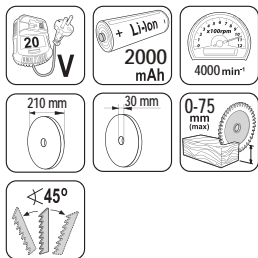

ART.NO.	BARCODE
030162	3800972019782

R20 CORDLESS RANDOM ORBIT SANDER

RDP-SRSA20 SOLO

• [BG] R20 Екцентършлайф • [RO] R20 Slefuitor orbital

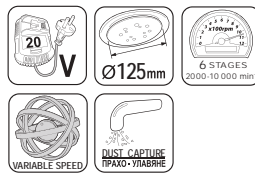

ART.NO.	BARCODE
030140	3800123168161

R20 CORDLESS RANDOM ORBIT SANDER

RDP-KRSA20 SOLO

• [BG] R20 Екцентършлайф • [RO] R20 Slefuitor orbital

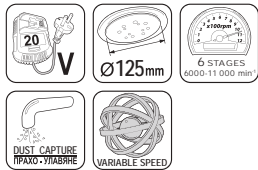

ART.NO.	BARCODE
030175	3800972030633

R20 CORDLESS RANDOM ORBIT SANDER

RDP-KRSA20

• [BG] R20 Екцентършлайф • [RO] R20 Slefuitor orbital

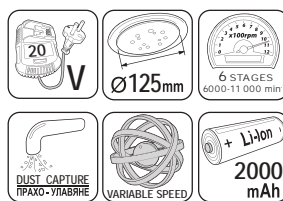

ART.NO.	BARCODE
030180	3800972030787

R20 CORDLESS MULTI-SANDER

RDP-YMSA20 SOLO

• [BG] R20 Мултишлайф • [RO] R20 Slefuitor multifunctional

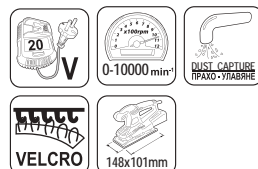

ART.NO.	BARCODE
040408	3800972032354

R20 CORDLESS MULTI-SANDER

RDP-SMSA20 SOLO

• [BG] R20 Мултишлайф • [RO] R20 Slefuitor multifunctional

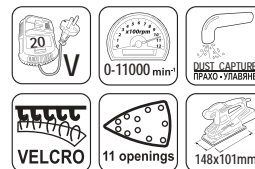

ART.NO.	BARCODE
040404	3800972025097

VELCRO SANDING SHEETS 11 HOLES 10 PCS.

RD

- [BG] Шкурка Velcro за мултишлайф
- [RO] Set 10 coli smirghel perforat Velcro Delta



ART.NO.	BARCODE	SIZE	P
180736	3800972025370	150x150x100 mm	P60
180737	3800972025387	150x150x100 mm	P80
180738	3800972025394	150x150x100 mm	P120
180739	3800972025400	150x150x100 mm	P180
180740	3800972025417	150x150x100 mm	SET

R20 CORDLESS BELT SANDER

SOLO RDP-SBS20

- [BG] R20 Шлайф лентов
- [RO] R20 Slefuitor cu banda

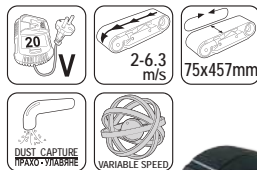

ART.NO.	BARCODE
043202	3800972025066

R20 DIE GRINDER

RDP-DG20

- [BG] R20 Шлайф прав
- [RO] R20 Polizor



ART.NO.	BARCODE
030347	3800972045071

R20 CORDLESS MULTI-TOOL

RDP-SOMT20 SOLO

- [BG] R20 Многофункционален инструмент
- [RO] R20 Unealta multifunctionala

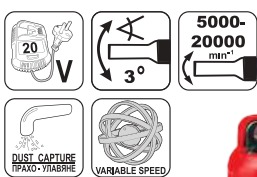

ART.NO.	BARCODE
030141	3800123168178

R20 BRUSHLESS CORDLESS MULTI-TOOL

RDP-BOMT20 SOLO

- [BG] R20 Многофункционален инструмент
- [RO] R20 Unealta multifunctionala

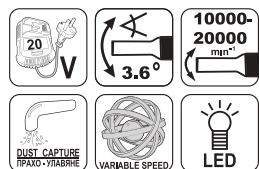

ART.NO.	BARCODE
030198	3800972038172

R20 CORDLESS HEAT GUN

RDP-BHG20 SOLO

- [BG] R20 Пистолет за горещ въздух
- [RO] R20 Pistol aer cald



ART.NO.	BARCODE
030160	3800972018884

R20 CORDLESS HEAT GUN

RDP-NHG20 SOLO

• [BG] R20 Пистолет за горещ въздух • [RO] R20 Pistol aer cald

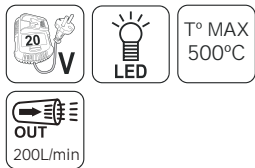

ART.NO. 041612
BARCODE 3800972043404

R20 CORDLESS HEAT GUN

RDP-NDHG20 SOLO

• [BG] R20 Пистолет за горещ въздух • [RO] R20 Pistol aer cald

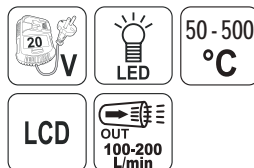

ART.NO. 041613
BARCODE 3800972043411

R20 HOT KNIFE FOAM CUTTER

RDP-HKFC20

• [BG] R20 Термо нож за изоляции • [RO] R20 Cutter electric spuma

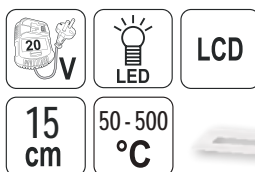

ART.NO. 041614
BARCODE 3800972043428

R20 CORDLESS HOT MELT GLUE GUN

RDP-SGLG20 SOLO

• [BG] R20 Пистолет за топло лепене • [RO] R20 Pistol de lipit

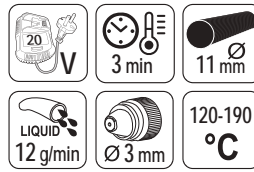

ART.NO. 030154
BARCODE 3800972014428

R20 CORDLESS HOT MELT GLUE GUN

RDP-YGLG20 SOLO

• [BG] R20 Пистолет за топло лепене • [RO] R20 Pistol de lipit

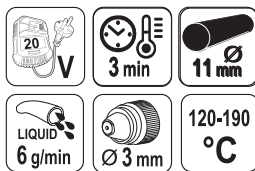

ART.NO. 030186
BARCODE 3800972032408

R20 CAULKING GUN

RDP-YCG20 SOLO

• [BG] R20 Пистолет за силикон • [RO] R20 Pistol silicon

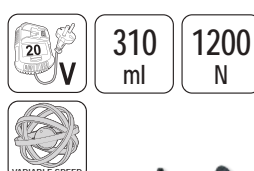

ART.NO. 041610
BARCODE 3800972032378

R20 CAULKING GUN

RDP-BCG20 SOLO

• [BG] R20 Пистолет за силикон • [RO] R20 Pistol silicon

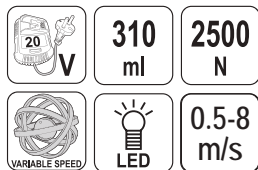

ART.NO. BARCODE
041611 3800972032460

R20 CAULKING GUN

RDP-JCG20 SOLO

• [BG] R20 Пистолет за силикон • [RO] R20 Pistol silicon

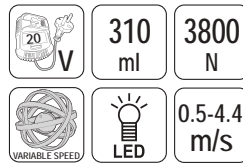

ART.NO. BARCODE
041607 3800972032019

R20 CAULKING GUN

RDP-SCG20 SOLO

• [BG] R20 Пистолет за силикон • [RO] R20 Pistol silicon

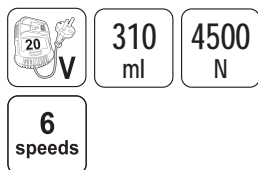

ART.NO. BARCODE
041604 3800972023574

R20 CAULKING GUN

RDP-CCG20 SOLO

• [BG] R20 Пистолет за силикон • [RO] R20 Pistol silicon

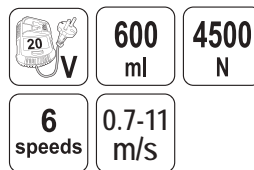

ART.NO. BARCODE
041605 3800972028982

R20 PPR PIPE WELDING SET 3

RDP-BPW20 SOLO

• [BG] R20 Пояльник за PP тръби • [RO] R20 Set sudura PPR

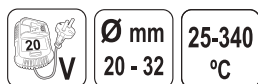

ART.NO. BARCODE
123112 3800972032491

R20 CORDLESS GREASE GUN

RDP-JGG20 SOLO

• [BG] R20 Такаламит • [RO] R20 Pistol pentru grasat



ART.NO. BARCODE
041606 3800972032002

R20 BRUSHLESS BLIND RIVET GUN

RDP-BBRG20 SOLO

• [BG] R20 Нитачка безчеткова • [RO] R20 Pistol nituri brushless

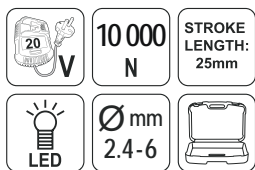

BRUSHLESS

ART.NO. 030199
BARCODE 3800972038202

R20 BRUSHLESS BLIND RIVET GUN

RDP-BRG20 SOLO

• [BG] R20 Нитачка безчеткова • [RO] R20 Pistol nituri brushless

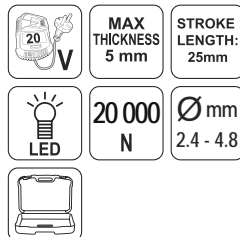

BRUSHLESS

ART.NO. 030188
BARCODE 3800972032507

R20 CORDLESS COMBI AIR STAPLER & NAILER

RDP-YST20 SOLO

• [BG] R20 Такер комбиниран • [RO] R20 Pistol capse si cuie

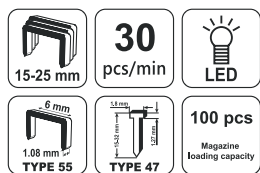

ART.NO. 030185
BARCODE 3800972032385

R20 CORDLESS COMBI AIR STAPLER & NAILER

RDP-SST20 SOLO

• [BG] R20 Такер комбиниран • [RO] R20 Pistol capse si cuie

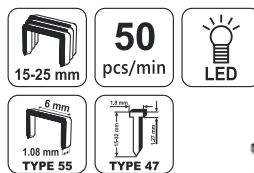

ART.NO. 030153
BARCODE 3800972014411

STAPLES TYPE 55 1000 PCS.

FOR RDP-SST20/RDP-YST20

• [BG] Скоби за акумулаторен такер • [RO] Set 1000 de capse

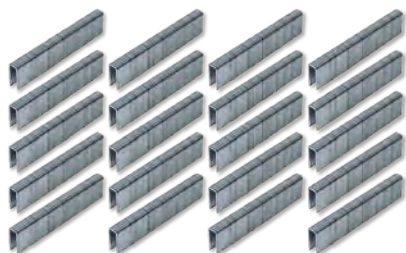

ART.NO.	BARCODE	SIZE
511412	3800972015661	14x6x1.08 mm
511413	3800972015678	16x6x1.08 mm
511414	3800972015685	20x6x1.08 mm
511415	3800972015692	25x6x1.08 mm

STAPLES TYPE 47 1000 PCS.

FOR RDP-SST20/RDP-YST20

• [BG] Скоби за акумулаторен такер • [RO] Set 1000 de capse

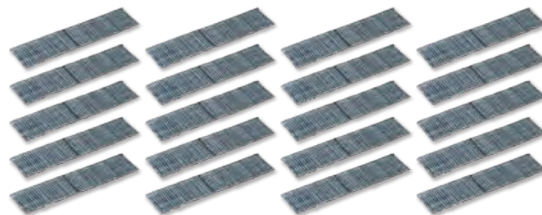

ART.NO.	BARCODE	SIZE
511416	3800972015708	15x1.08 mm
511417	3800972015715	20x1.08 mm
511418	3800972015722	25x1.08 mm
511419	3800972015739	32x1.08 mm

R20 CORDLESS SPRAY GUN

RDP-YSG20 SOLO

• [BG] R20 Пистолет за боя • [RO] R20 Pistol de vopsit

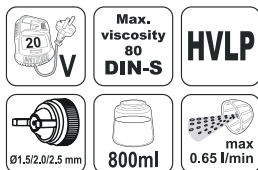

ART.NO. BARCODE
074208 3800972038370

R20 CORDLESS SPRAY GUN

RDP-CSGC20 SOLO

• [BG] R20 Пистолет за боя • [RO] R20 Pistol de vopsit



ART.NO. BARCODE
074203 3800972031197

R20 CORDLESS BENCH GRINDER

RDP-SCBG20 SOLO

• [BG] R20 Шмиргел • [RO] R20 polizor de banc



ART.NO. BARCODE
061201 3800972023543

R20 GRINDING WHEEL G100

FOR RDP-SCBG20

• [BG] R20 Диск за шмиргел • [RO] R20 Piatra polizor



ART.NO. BARCODE SIZE
165128 3800972025042 Ø50xØ13 mm G100

R20 GRINDING WHEEL G80

FOR RDP-SCBG20

• [BG] R20 Диск за шмиргел • [RO] R20 Piatra polizor



ART.NO. BARCODE SIZE
165129 3800972025059 Ø50xØ13 mm G80

R20 CORDLESS PLANER

RDP-SEP20 SOLO

• [BG] R20 Ренде • [RO] R20 rindea cordless



ART.NO. BARCODE
055203 3800972023550

R20 CORDLESS ROUTER

RDP-CER20 SOLO

• [BG] R20 Оберфреза • [RO] R20 Freza electrica



ART.NO. BARCODE
055204 3800972033313

R20 POLISHER RDP-JPC20 SOLO

• [BG] R20 Полирмашина • [RO] R20 Masina de polisat

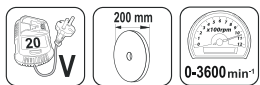

ART.NO. BARCODE
041609 3800972032361

R20 BRUSHLESS POLISHER RDP-JPC20 SOLO

• [BG] R20 Полирмашина безчеткова • [RO] R20 Masina de polisat

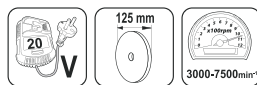

BRUSHLESS

DUAL ACTION

ART.NO. BARCODE
041608 3800972032026

R20 BRUSHLESS CORDLESS POLISHER RDP-SPC20 SOLO

• [BG] R20 Полирмашина безчеткова • [RO] R20 Masina de polisat

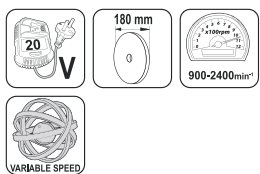

BRUSHLESS

ART.NO. BARCODE
041603 3800972023567

R20 CORDLESS AIR PUMP RDP-JAP20 SOLO

• [BG] R20 Мини компресор • [RO] R20 Pompa de aer



ART.NO. BARCODE
089414 3800972032033

R20 MINI AIR COMPRESSOR RDP-YAC20 SOLO

• [BG] R20 Мини компресор • [RO] R20 Mini compresor de aer

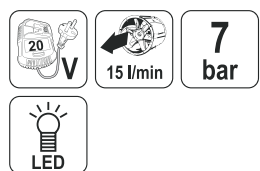

ART.NO. BARCODE
089418 3800972032415

R20 CORDLESS AIR COMPRESSOR RDP-JAC20 SOLO

• [BG] R20 Компресор • [RO] R20 Compresor aer

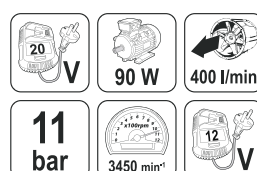

ART.NO. BARCODE
089411 3800972031968

R20 CORDLESS AIR COMPRESSOR

RDP-J4AC20 SOLO

• [BG] R20 Компресор • [RO] R20 Compresor aer



8 bar



ART.NO. 089413
BARCODE 3800972031999

R20 CORDLESS AIR COMPRESSOR

RDP-J6AC20 SOLO

• [BG] R20 Компресор • [RO] R20 Compresor aer



9 bar



ART.NO. 089412
BARCODE 3800972031982

R20 CORDLESS DRY VACUUM CLEANER

RDP-SMWC20 SOLO

• [BG] R20 Прахосмукачка за сухо почистване • [RO] R20 Aspirator praf



ART.NO. 090329
BARCODE 3800972025103

R20 HEPA FILTER

FOR RDP-SMWC20

• [BG] R20 Хепа филтър за прахосмукачка
• [RO] R20 Filtru HEPA pentru aspirator



ART.NO. 090336
BARCODE 3800972033405

R20 FILTER SET 3 PCS.

FOR RDP-SMWC20

• [BG] R20 3бр. Филтри за прахосмукачка
• [RO] R20 Aspirator cenusă



ART.NO. 090331
BARCODE 3800972025424

R20 CORDLESS WET & DRY VACUUM CLEANER

RDP-SDWC20 SOLO

• [BG] R20 Прахосмукачка за сухо и мокро почистване • [RO] R20 Aspirator umed/uscat



1300 l/m



ART.NO. 090319
BARCODE 3800972015883

R20 BRUSHLESS CORDLESS WET & DRY VACUUM CLEANER

RDP-SDWCH20 SOLO

• [BG] R20 Прахосмукачка за сухо и мокро безчеткова • [RO] R20 Aspirator motor fara perii 1



630 l/m



BRUSHLESS

ART.NO. 090330
BARCODE 3800972025363

R20 CORDLESS ASH VACUUM CLEANER

RDP-SWC20 SOLO

• [BG] R20 Прахосмукачка за пепел • [RO] R20 Aspirator cenusa

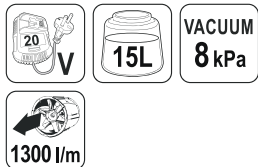

ART.NO. BARCODE
090315 3800972015845

HEPA FILTER

FOR RD-WC06,8,9,10 SWC20 SDWC20

• [BG] Хепа филтър • [RO] Filtru HEPA

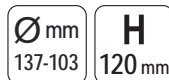

ART.NO. BARCODE
090320 3800972015890

R20 CORDLESS PRESSURE CLEANER

RDP-CHPC20 SET

• [BG] R20 Водоструйка • [RO] R20 Aparat spalat cu presiune



ART.NO. BARCODE
072110 3800972031395

R20 CORDLESS WORK FAN

RDP-SWF20 SOLO

• [BG] R20 Вентилатор • [RO] R20 ventilator de lucru cu

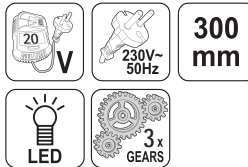

ART.NO. BARCODE
039711 3800972023611

R20 WORK LIGHT DIMMER

RDP-ZWL20 SOLO

• [BG] R20 Лампа работна • [RO] R20 Lampa de lucru

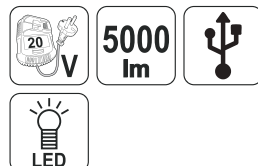

ART.NO. BARCODE
039718 3800972035300

R20 WORK LIGHT DIMMER

RDP-ZAWL20 SOLO

• [BG] R20 Лампа работна • [RO] R20 Lampa de lucru

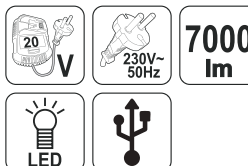

ART.NO. BARCODE
039719 3800972035317

CONNECTOR COMPATIBLE WITH BOSCH 18V RDP-R20 SYSTEM/FOR RDP-ZAWL20

• [BG] Конектор за BOSCH 18V • [RO] Connector compatible with BOSCH 18V



ART.NO.	BARCODE
710308	3800972035362

CONNECTOR COMPATIBLE WITH METABO 18V RDP-R20 SYSTEM/FOR RDP-ZAWL20

• [BG] Конектор за Metabo 18V • [RO] Connector compatible with Metabo 18V



ART.NO.	BARCODE
710309	3800972035379

CONNECTOR COMPATIBLE WITH MAKITA 18V RDP-R20 SYSTEM/FOR RDP-ZAWL20

• [BG] Конектор за Makita 18V • [RO] Connector compatible with Makita 18V



ART.NO.	BARCODE
710310	3800972035386

CONNECTOR COMPATIBLE WITH DEWALT 20V RDP-R20 SYSTEM/FOR RDP-ZAWL20

• [BG] Конектор за DeWalt 20V • [RO] Connector compatible with DeWalt 20V



ART.NO.	BARCODE
710311	3800972035393

R20 ADAPTER USB WITH LAMP RDP-R20 SYSTEM

• [BG] R20 Адаптер с лампа • [RO] R20 adaptor USB cu lampa



ART.NO.	BARCODE
039706	3800972014442

R20 BLUETOOTH RADIO RDP-BR20 SOLO

• [BG] R20 Радио • [RO] R20 Radio Bluetooth

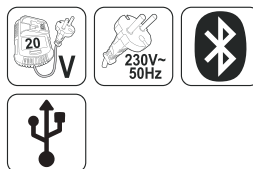

ART.NO.	BARCODE
039716	3800972028968

PLASTIC CASE

RDP

• [BG] Куфар с две дръжки • [RO] Cutie plastic



ART.NO.	BARCODE	SIZE
710312	3800972036543	44x33x14 cm

PLASTIC CASE

RDP

• [BG] Куфар • [RO] Cutie plastic



ART.NO.	BARCODE	SIZE
710313	3800972036550	55x38x12 cm

PLASTIC CASE

RDP

• [BG] Куфар • [RO] Cutie de transport unelte



ART.NO.	BARCODE	SIZE
030354	3800972045149	44x34,2x13,2 cm

R20 WATER PUMP

RDP-CWP20 SOLO

• [BG] R20 Помпа • [RO] R20 Pompa

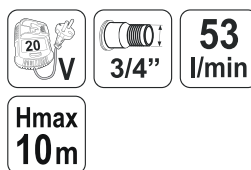

ART.NO.	BARCODE
075753	3800972031777

R20 WATER PUMP

RDP-ALWP20 SOLO

• [BG] R20 Помпа • [RO] R20 Pompa

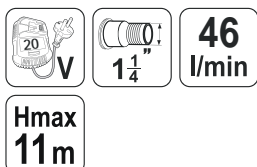

ART.NO.	BARCODE
075754	3800972031784

R20 WATER PUMP

RDP-FWP20 SOLO

• [BG] R20 Помпа • [RO] R20 Pompa



ART.NO.	BARCODE
075760	3800972032200

R20 WATER PUMP & DIESEL & OIL

RDP-JWP20 SOLO

• [BG] R20 Помпа водна&Diesel&Oil • [RO] R20 Pompa apa-motorina-ulei



ART.NO. BARCODE
075759 3800972031975

R20 BRUSHLESS CORDLESS TILLER

RDP-BCT20 SOLO

• [BG] R20 Мотофреза безчеткова • [RO] R20 Motosapa electrica

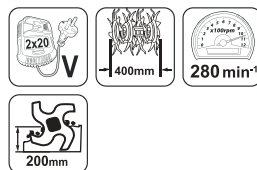

BRUSHLESS

ART.NO. BARCODE
075787 3800972041165

R20 BRUSHLESS CORDLESS PRUNING SHEAR

RDP-BPSH20 SOLO

• [BG] R20 Ножица лозарска безчеткова • [RO] R20 Foarfeca de gradina brushless



BRUSHLESS

ART.NO. BARCODE
075773 3800972038189

R20 BRUSHLESS PRUNING SHEARS

RDP-BPSH20 SET

• [BG] R20 Ножица лозарска безчеткова • [RO] R20 Foarfeca de gradina brushless

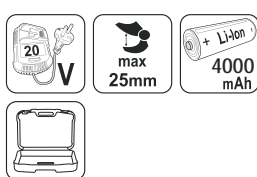

BRUSHLESS

ART.NO. BARCODE
030345 3800972045057

R20 BRUSHLESS CORDLESS PRUNING SHEARS

RDP-BPS20 SOLO

• [BG] R20 Ножица овощаро-лозарска безчеткова
• [RO] R20 Foarfeca de gradina brushless



BRUSHLESS

ART.NO. BARCODE
075774 3800972038196

R20 CORDLESS GRASS SHEARS & HEDGE TRIMMER 2IN1

RDP-KGSHT20 SET

• [BG] R20 Ножица за трева и храсти 2в1
• [RO] R20 Foarfeca gazon si trimmer gard viu 2in1

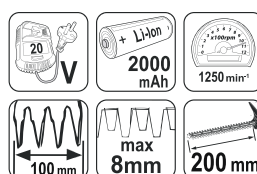

ART.NO. BARCODE
075657 3800972030800

R20 CORDLESS KNAPSACK SPRAYER

RDP-SBKMD20 SOLO

• [BG] R20 Пръскачка • [RO] R20 Pulverizator cu acumulator

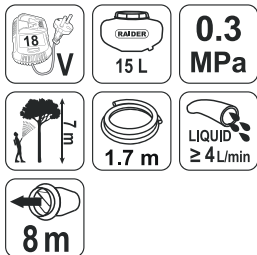

ART.NO. 098106
BARCODE 3800972023598

R20 CORDLESS KNAPSACK SPRAYER

RDP-BKMD20 SET

• [BG] R20 Пръскачка • [RO] R20 Pulverizator cu acumulator

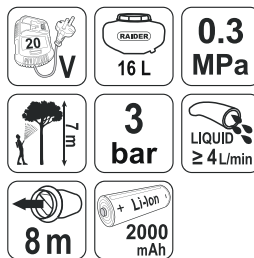

ART.NO. 098109
BARCODE 3800972033023

R20 CORDLESS POLE SAW

RDP-PS20 SET

• [BG] R20 Кастръчка • [RO] R20 Fierastrau cu lant

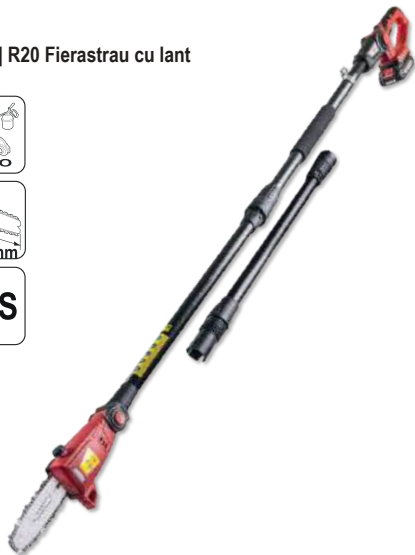
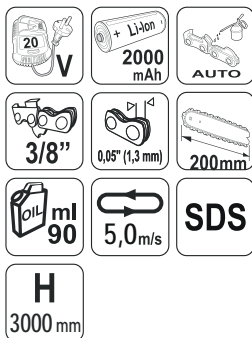

ART.NO. 075739
BARCODE 3800972029309

R20 CORDLESS POLE SAW

RDP-PSHT20 SET

• [BG] R20 Кастръчка • [RO] R20 Fierastrau cu lant

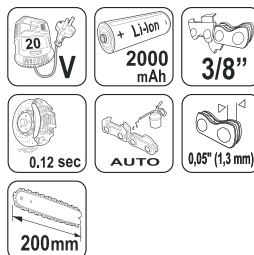

ART.NO. 075740
BARCODE 3800972029316

R20 CORDLESS HEDGE TRIMMER

RDP-YHT20 SOLO

• [BG] R20 Кастръчка и Хросторез • [RO] R20 Trimmer gard viu

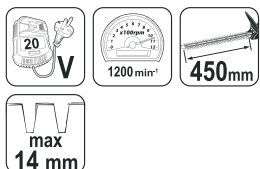

ART.NO. 075766
BARCODE 3800972034051

R20 CORDLESS HEDGE TRIMMER

RDP-SCHT20 SOLO

• [BG] R20 Хросторез • [RO] R20 Trimmer gard viu

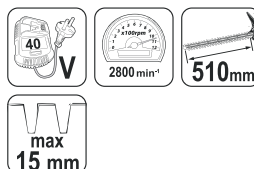

ART.NO. 075707
BARCODE 3800972014688

R20 CORDLESS HEDGE TRIMMER

RDP-KHT20 SET

• [BG] R20 Храсторез • [RO] R20 Trimmer gard viu

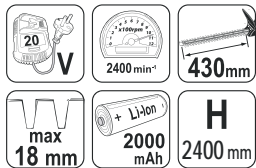

ART.NO. 075749
BARCODE 3800972030671

R20 CORDLESS HEDGE TRIMMER

FOR RDP-SBBC20

• [BG] R20 Храсторез • [RO] R20 Trimmer gard viu



ART.NO. 075713
BARCODE 3800972016682

R20 POLE SAW HEAD WITH TUBE

FOR RDP-SBBC20

• [BG] R20 Кастрачка • [RO] R20 Cap fierastru



ART.NO. 075712
BARCODE 3800972016675

R20 BRUSHLESS CORDLESS BRUSH CUTTER

SOLO RDP-GXBC20

• [BG] R20 Коса безчеткова • [RO] R20 Trimmer brushless



BRUSHLESS

ART.NO. 075770
BARCODE 3800972035843

R20 BRUSHLESS CORDLESS BRUSH CUTTER

RDP-BBC20 SET

• [BG] R20 Коса безчеткова • [RO] R20 Trimmer brushless



BRUSHLESS

FOLDABLE

ART.NO. 075736
BARCODE 3800972028562

R20 BRUSHLESS CORDLESS BRUSH CUTTER

RDP-SBC20 SOLO

• [BG] R20 Коса безчеткова • [RO] R20 Trimmer brushless

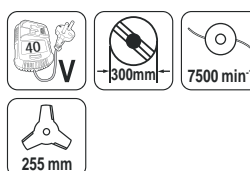

BRUSHLESS

FOLDABLE

ART.NO. 075786
BARCODE 3800972041158

R20 BRUSHLESS CORDLESS BRUSH CUTTER

RDP-BCPSHT20 SET

• [BG] R20 Коса безчеткова • [RO] R20 Trimmer brushless



BRUSHLESS



ART.NO.	BARCODE
075741	3800972029323

R20 BRUSHLESS CORDLESS LAWN MOWER

RDP-BLM20 SOLO

• [BG] R20 Косачка безчеткова • [RO] R20 Masina tuns iarba brushless

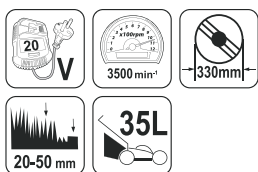

BRUSHLESS



ART.NO.	BARCODE
075343	3800972029903

R20 BLADE

FOR RDP-BLM20

• [BG] R20 Нож за косачка
• [RO] R20 Lama pentru masina tuns iarba brushless

**33
cm**



ART.NO.	BARCODE
110324	3800972029910

R20 GRASS BAG

FOR RDP-BLM20

• [BG] R20 Кош за косачка
• [RO] R20 Sac pentru masina de tuns iarba

50L



ART.NO.	BARCODE
110350	3800972031425

R20 BRUSHLESS CORDLESS LAWN MOWER

RDP-BCLM20

• [BG] R20 Косачка безчеткова • [RO] R20 Masina tuns iarba brushless

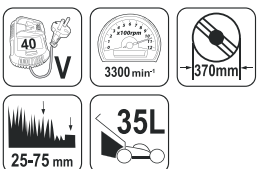

BRUSHLESS



ART.NO.	BARCODE
075350	3800972029927

R20 BLADE

FOR RDP-BCLM20

• [BG] R20 Нож за косачка
• [RO] R20 Lama pentru masina tuns iarba brushless

**37
cm**



ART.NO.	BARCODE
110325	3800972029934

R20 GRASS BAG

FOR RDP-BCLM20

• [BG] R20 Кош за косачка
• [RO] R20 Sac pentru masina de tuns iarba

50L



ART.NO.	BARCODE
110351	3800972031432

R20 BRUSHLESS CORDLESS LAWN MOWER

RDP-HBLM20 SOLO

• [BG] R20 Косачка безчеткова • [RO] R20 Masina tuns iarba brushless

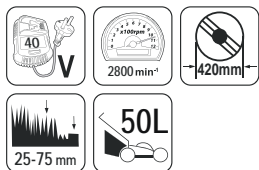

BRUSHLESS



ART.NO. BARCODE
075359 3800972040861

R20 BLADE

FOR RDP-HBLM20

• [BG] R20 Нож за косачка
• [RO] R20 Lama pentru masina tuns iarba brushless

42 cm



ART.NO. BARCODE
075364 3800972041066

R20 GRASS BAG

FOR RDP-HBLM20

• [BG] R20 Кош за косачка
• [RO] R20 Sac pentru masina de tuns iarba

50L



ART.NO. BARCODE
075365 3800972041073

R20 CORDLESS GRASS TRIMMER

RDP-YGT20 SOLO

• [BG] R20 Косачка-тример • [RO] R20 Trimmer gazon



AL



ART.NO. BARCODE
075764 3800972034037

R20 TRIMMER LINE ON SPOOL WITH CAP

FOR RDP-YGT20

• [BG] R20 Корда с макара и капачка • [RO] R20 Mosor fir trimmer fara suport



ART.NO. BARCODE
075765 3800972034044

R20 CORDLESS BLOWER

RDP-YBL20 SOLO

• [BG] R20 Уред за обдухване • [RO] R20 Suflanta frunze



SPEED 180 km/h



ART.NO. BARCODE
075767 3800972034068

R20 CORDLESS BLOWER

RDP-QBL20 SOLO

• [BG] R20 Уред за обдухване • [RO] R20 Suflanta frunze



VARIABLE SPEED



ART.NO. BARCODE
075785 3800972040915

R20 CORDLESS BLOWER

RDP-BL20 SOLO

• [BG] R20 Уред за обдухване • [RO] R20 Suflanta frunze

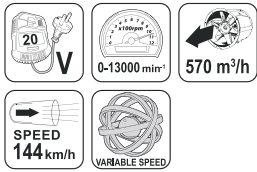

ART.NO.	BARCODE
075745	3800972029880

R20 CORDLESS BLOWER VACUUM AND SHREDDER

RDP-SEBV20 SOLO

• [BG] R20 Листосъбирач • [RO] R20 Suflanta de frunze cu tocat

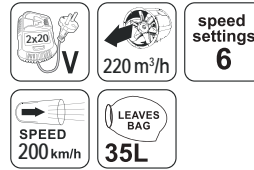

ART.NO.	BARCODE
077403	3800972023581

R20 CORDLESS BLOWER

RDP-BBL20 SOLO

• [BG] R20 Уред за обдухване • [RO] R20 Suflanta frunze

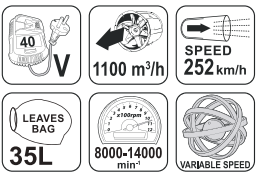

3 FUNCTION

ART.NO.	BARCODE
075746	3800972029897



R20 BLOWER VACUUM & SHREDDE

RDP-EBV20 SOLO

• [BG] R20 Листосъбирач • [RO] R20 Suflanta de frunze cu tocat

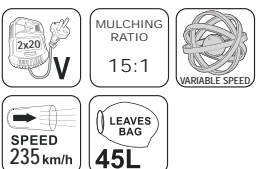

ART.NO.	BARCODE
077406	3800972040847

R20 BAG FOR BLOWER VACUUM

FOR RDP-EBV20

• [BG] R20 Торба за листосъбирач • [RO] R20 Sac colector pentru aspirator suflant



ART.NO.	BARCODE
077407	3800972041059

R20 BLOWER VACUUM & SHREDDE

RDP-SEBV20 SOLO

• [BG] R20 Листосъбирач • [RO] R20 Sufianta de frunze cu tocat

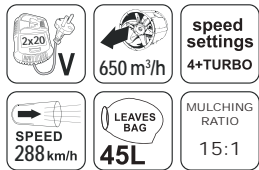

BRUSHLESS

3in1



ART.NO. 077408
BARCODE 3800972041134

R20 BAG FOR BLOWER VACUUM

FOR RDP-SEBV20

• [BG] R20 Торба за листосъбирач
• [RO] R20 Sac colector pentru aspirator suflant



ART.NO. 077409
BARCODE 3800972041141

R20 BRUSHLESS CORDLESS GARDEN PRUNER

RDP-SBGP20 SET

• [BG] R20 Резачка безчеткова • [RO] R20 Fierastrau cu lant

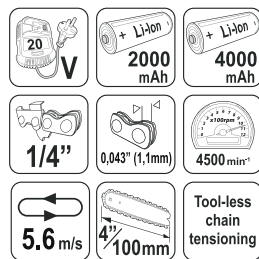

BRUSHLESS



ART.NO. 075719
BARCODE 3800972024274

R20 SAW CHAIN

FOR RDP-SBGP20

• [BG] R20 Верига за верижен трион
• [RO] R20 Lant



ART.NO. 140126
BARCODE 3800972024366

R20 GUIDE BAR

FOR RDP-SBGP20

• [BG] R20 Шина за верижен трион
• [RO] Lama motofierastrau

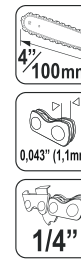

ART.NO. 140127
BARCODE 3800972024373

R20 CORDLESS GARDEN PRUNER

RDP-CLGP20 SET

• [BG] R20 Резачка • [RO] R20 Fierastrau cu lant

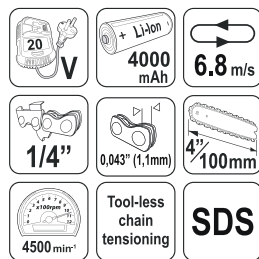

ART.NO. 075738
BARCODE 3800972029293

R20 CORDLESS GARDEN PRUNER

RDP-GP20 SOLO

• [BG] R20 Резачка • [RO] R20 Fierastrau cu lant

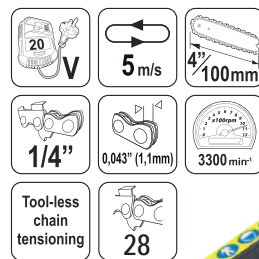

ART.NO. 075721
BARCODE 3800972029262

R20 CORDLESS GARDEN PRUNER

RDP-YGP20 SOLO

• [BG] R20 Резачка • [RO] R20 Fierastrau cu lant



ART.NO. BARCODE
075761 3800972032392

R20 SAW CHAIN

FOR RDP-YGP20

• [BG] R20 Верига за верижен трион
• [RO] R20 Lant

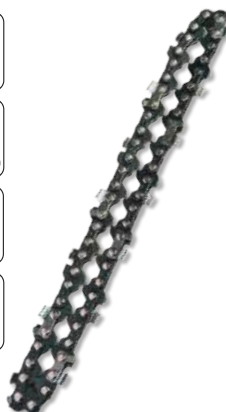

ART.NO. BARCODE
075778 3800972038394

R20 GUIDE BAR

FOR RDP-YGP20

• [BG] R20 Шина за верижен трион
• [RO] Lama motofierastrau

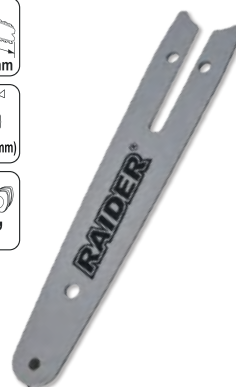

ART.NO. BARCODE
075776 3800972038387

R20 CORDLESS GARDEN PRUNER

RDP-YGP20 SET

• [BG] R20 Резачка • [RO] R20 Fierastrau cu lant

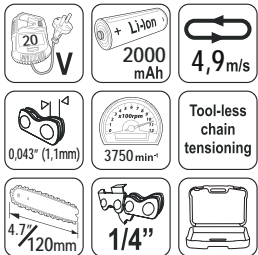

ART.NO. BARCODE
075768 3800972034563



R20 CORDLESS CHAIN SAW

RDP-CCS20 SOLO

• [BG] R20 Резачка • [RO] R20 Fierastrau cu lant



ART.NO. BARCODE
075734 3800972028524

SAW CHAIN

FOR RDP-CCS20

• [BG] R20 Верига за верижен трион
• [RO] R20 Lant

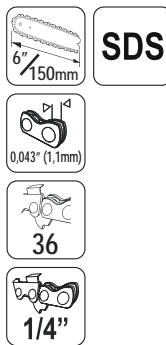

ART.NO. BARCODE
140133 3800972028548

R20 GUIDE-BAR

FOR RDP-CCS20

• [BG] R20 Шина за верижен трион
• [RO] R20 Lama ghidaj



ART.NO. BARCODE
140134 3800972028555

R20 CORDLESS CHAIN

RDP-CCS20 SET

• [BG] R20 Резачка • [RO] R20 Fierastrau cu lant

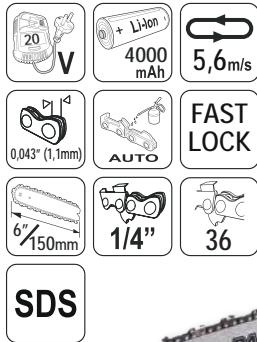

ART.NO. BARCODE
075735 3800972028531



R20 CORDLESS CHAIN SAW

RDP-KCCS20 SOLO

• [BG] R20 Резачка • [RO] R20 Fierastrau cu lant



ART.NO. BARCODE
075748 3800972030657

SAW CHAIN

FOR RDP-KCCS20

• [BG] R20 Верига за резачка
• [RO] R20 Lant



ART.NO. BARCODE
140141 3800972030831

R20 GUIDE BAR

FOR RDP-KCCS20

• [BG] R20 Шина за верижен трион
• [RO] Lama motofierastrau

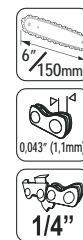

ART.NO. BARCODE
140142 3800972030848

R20 BRUSHLESS CHAIN SAW

RDP-TBCHS20 SOLO

• [BG] R20 Резачка безчеткова
• [RO] R20 Fierastrau cu lant

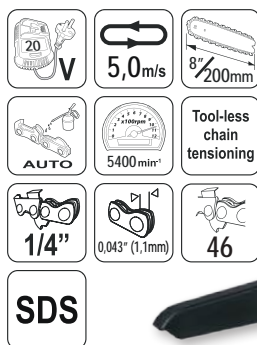

ART.NO. BARCODE
075763 3800972032583

R20 SAW CHAIN

FOR RDP-TBCHS20

• [BG] R20 Верига за резачка
• [RO] R20 Lant



ART.NO. BARCODE
141320 3800972032620

R20 GUIDE-BAR

FOR RDP-TBCHS20

• [BG] R20 Шина за резачка
• [RO] R20 Lama ghidaj



ART.NO. BARCODE
141321 3800972032637

R20 BRUSHLESS CHAIN SAW

RDP-RBCS20 SOLO

• [BG] R20 Резачка безчеткова • [RO] R20 Fierastrau electric cu lant

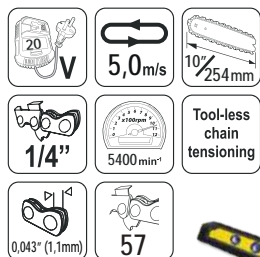

BRUSHLESS



ART.NO. BARCODE
141324 3800972039919

R20 BRUSHLESS CHAIN SAW

RDP-RBCS20 SET

• [BG] R20 Резачка безчетков • [RO] 20 Fierastrau electric cu lant

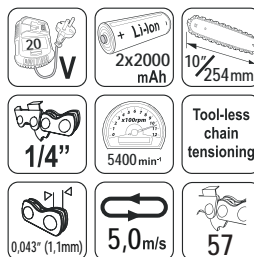

BRUSHLESS



ART.NO. BARCODE
141325 3800972046023

R20 BRUSHLESS CHAIN SAW

RDP-GXBCS20 SOLO

• [BG] R20 Резачка безчетков • [RO] R20 Fierastrau cu lant

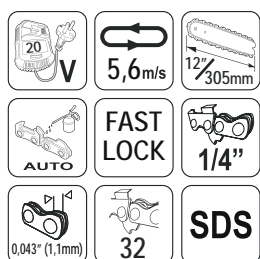

BRUSHLESS



ART.NO. BARCODE
075769 3800972035812

R20 SAW CHAIN

FOR RDP-GXBCS20

• [BG] R20 Верига за резачка
• [RO] R20 Lant

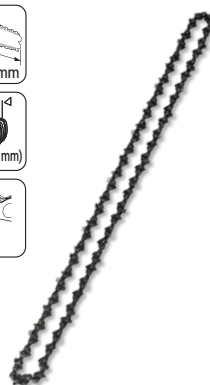

ART.NO. BARCODE
141322 3800972035829

R20 GUDE-BAR

FOR RDP-GXBCS20

• [BG] R20 Шина за резачка
• [RO] R20 Lama ghidaj



ART.NO. BARCODE
141323 3800972035836

R20 BRUSHLESS CORDLESS CHAIN SAW

RDP-DBCS20 SOLO

• [BG] R20 Резачка безчеткова • [RO] R20 Fierastrau cu lant

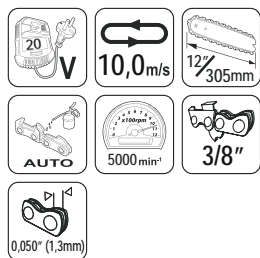

BRUSHLESS



ART.NO. BARCODE
075775 3800972038332

R20 CORDLESS CHAIN SAW

RDP-SCHS20 SOLO

• [BG] R20 Резачка • [RO] R20 Fierastrau cu lant

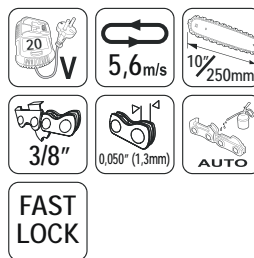

ART.NO. BARCODE
075710 3800972016651

R20 CORDLESS CHAIN SAW

RDP-SCHS20 SET

• [BG] R20 Резачка • [RO] R20 Fierastrau cu lant

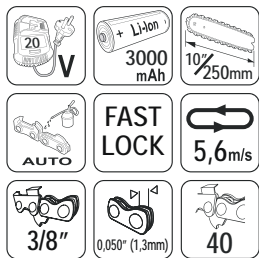

ART.NO. 075709
BARCODE 3800972016644

R20 GUIDE BAR

FOR RDP-SCHS20

• [BG] R20 Шина за верижен трион • [RO] Lama motofierastrau



ART.NO. 141315
BARCODE 3800972019751

R20 BRUSHLESS CORDLESS CHAIN SAW

RDP-HBCS20 SOLO

• [BG] R20 Резачка безчеткова • [RO] R20 Fierastrau cu lant



ART.NO. 075784
BARCODE 3800972040854

R20 BRUSHLESS CORDLESS CHAIN SAW

RDP-SBCS20 SOLO

• [BG] R20 Резачка безчеткова • [RO] R20 Fierastrau cu lant

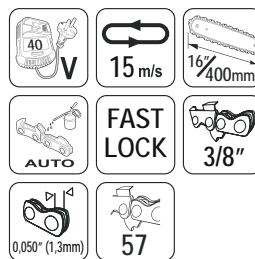

ART.NO. 075724
BARCODE 3800972025332

R20 BRUSHLESS CORDLESS CHAIN SAW

RDP-SBCS20 SET

• [BG] R20 Резачка безчеткова • [RO] R20 Fierastrau cu lant

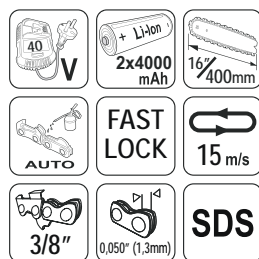

ART.NO. 075737
BARCODE 3800972028579

R20 GUIDE BAR

FOR RDP-SBCS20

• [BG] R20 Шина за верижен трион • [RO] R20 Lama ghidaj

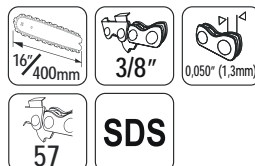

ART.NO. 140135
BARCODE 3800972028586

R20 SET 3 BRUSHLESS MACHINES

RDP-BXS1

- [BG] R20 Комплект 3 безчеткови машини
- [RO] R20 Set 3 Maşini fără perii

11 PCS. SET



ART.NO. 030320
BARCODE 3800972039766

R20 SET 2 MACHINES

RDP-BXS2

- [BG] R20 Комплект 2 машини
- [RO] R20 Set 2 Maşini fără perii

7 PCS. SET



ART.NO. 030321
BARCODE 3800972039773

R20 SET 3 MACHINES

RDP-BXS3

- [BG] R20 Комплект 3 машини
- [RO] R20 Set 3 Maşini fără perii

9 PCS. SET



ART.NO. 030322
BARCODE 3800972039780

R20 SET 4 MACHINES

RDP-BXS4

- [BG] R20 Комплект 4 машини
- [RO] R20 Set 4 Maşini fără perii

9 PCS. SET



ART.NO. 030323
BARCODE 3800972039797

R20 SET 2 MACHINES RDP-BXS5

- [BG] R20 Комплект 2 машини
- [RO] R20 Set 2 Maşini fără perii

7 PCS. SET



ART.NO. 030324
BARCODE 3800972039803

R20 SET 4 MACHINE RDP-BXS6

- [BG] R20 Комплект 4 машини
- [RO] R20 Set 4 Maşini fără perii

8 PCS. SET



ART.NO. 030325
BARCODE 3800972039810

R20 SET 2 MACHINES RDP-BXS7 GARDEN

- [BG] R20 Комплект 2 машини
- [RO] R20 Set 2 Maşini fără perii



ART.NO. 030326
BARCODE 3800972039827

R20 SET 2 MACHINES RDP-BXS8 GARDEN

- [BG] R20 Комплект 2 машини
- [RO] R20 Set 2 Maşini fără perii

7 PCS. SET



ART.NO. 030327
BARCODE 3800972039834

R20 SET 2 MACHINES

RDP-BXS9

- [BG] R20 Комплект 2 машини
- [RO] R20 Set 2 Maşini fără perii

5 PCS. SET



ART.NO. 030328
 BARCODE 3800972039841

R20 SET 3 MACHINES

RDP-BXS10

- [BG] R20 Комплект 3 машини
- [RO] R20 Set 3 Maşini fără perii

7 PCS. SET



ART.NO. 030329
 BARCODE 3800972039858

R20 SET 3 MACHINES

RDP-BXS11

- [BG] R20 Комплект 3 машини
- [RO] R20 Set 3 Maşini fără perii

9 PCS. SET



ART.NO. 030330
 BARCODE 3800972039865

R20 SET 4 MACHINES

RDP-BXS12

- [BG] R20 Комплект 4 машини
- [RO] R20 Set 4 Maşini fără perii

10 PCS. SET



ART.NO. 030331
 BARCODE 3800972039872

R20 SET 3 MACHINES

RDP-BXS13

- [BG] R20 Комплект 3 машини
- [RO] R20 Set 3 Maşini fără perii



ART.NO. 030332
BARCODE 3800972039889

R20 SET 3 BRUSHLESS MACHINES

RDP-BXS14

- [BG] R20 Комплект 3 машини
- [RO] R20 Set 3 Maşini fără perii



ART.NO. 030333
BARCODE 3800972040922

R20 SET 5 BRUSHLESS

RDP-BXS15

- [BG] R20 Комплект 5 безчеткови машини
- [RO] R20 Set 5 Maşini fără perii

15 PCS. SET



ART.NO. 030335
BARCODE 3800972044951

R20 SET 5 MACHINES

RDP-BXS16

- [BG] R20 Комплект 5 машини
- [RO] R20 Set 5 Maşini fără perii



ART.NO. 030336
BARCODE 3800972044968

R20 SET 2 MACHINES

RDP-BXS17

- [BG] R20 Комплект 2 машини
- [RO] R20 Set 2 Maşini fără perii



ART.NO. 030337
 BARCODE 3800972044975

R20 SET 3 BRUSHLESS

RDP-BXS18

- [BG] R20 Комплект 3 машини безчетков
- [RO] R20 Set 3 Maşini fără perii



ART.NO. 030338
 BARCODE 3800972044982

R20 SET 2 BRUSHLESS

RDP-BXS19

- [BG] R20 Комплект 2 машини безчетков
- [RO] R20 Set 2 Maşini fără perii



ART.NO. 030339
 BARCODE 3800972044999

R20 SET 2 BRUSHLESS

RDP-BXS20

- [BG] R20 Комплект 2 машини безчетков
- [RO] R20 Set 2 Maşini fără perii



ART.NO. 030340
 BARCODE 3800972045002

R20 SET 2 BRUSHLESS

RDP-BXS21

- [BG] R20 Комплект 2 машини безчетков
- [RO] R20 Set 2 Maşini fără perii



ART.NO.	BARCODE
030341	3800972046019

CORDLESS SCREWDRIVER

RD-CSCLO4

• [BG] Отвертка акумулаторна • [RO] Surubelnita cu acumulator mandrina hex



ART.NO. 031201
BARCODE 3800972001558

CORDLESS SCREWDRIVER

RD-CSC05

• [BG] Отвертка акумулаторна • [RO] Surubelnita cu acumulator mandrina hex



ART.NO. 031129
BARCODE 3800972030114

CORDLESS DRILL

RDP-CDL30 BLACK EDITION

• [BG] Бормашина акумулаторна • [RO] Masina de gaurit si insurubat



RAIDER®
Pro

ART.NO. 030214
BARCODE 3800972016491

CORDLESS DRILL

RD-CDL34

• [BG] Бормашина акумулаторна • [RO] Masina de gaurit si insurubat



ART.NO. 030163
BARCODE 3800972022621

BATTERY

3A RD-CDL34

• [BG] Батерия • [RO] Акумулатор



ART.NO. 131163
BARCODE 3800972022638

CHARGER FOR CORDLESS DRILL

3A RD-CDL34

• [BG] Зарядно 12V • [RO] Incarcator 12V



ART.NO. 032132
BARCODE 3800972022645

CORDLESS DRILL

RD-CDL33

• [BG] Бормашина акумулаторна • [RO] Masina de gaurit si insurubat



ART.NO. BARCODE
030161 3800972019713

CORDLESS DRILL

RD-CDL35

• [BG] Бормашина акумулаторна • [RO] Masina de gaurit si insurubat



ART.NO. BARCODE
030165 3800972025837

CORDLESS GARDEN PRUNER

RD-GP21 SET

• [BG] Резачка • [RO] Fierastrau cu lant

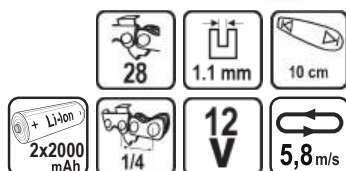

ART.NO. BARCODE
075720 3800972024281

SAW CHAIN

3A RD-GP21 И GP24

• [BG] Верига за верижен трион • [RO] Lant pentru drujba

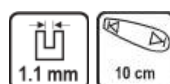

ART.NO. BARCODE
140132 3800972027107

CORDLESS GARDEN PRUNER

RD-GP24 SET

• [BG] Резачка • [RO] Fierastrau cu lant

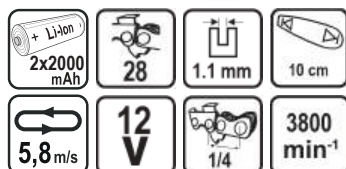

ART.NO. BARCODE
075726 3800972026742

CORDLESS DRILL & GARDEN PRUNER

RDP-CDLGP02

• [BG] Бормашина & Резачка акумулаторни
• [RO] Set Bormasina si fierastrau electric



ART.NO. BARCODE
075733 3800972028487

CORDLESS ANGLE GRINDER

RD-CAG72

• [BG] Ъглошлайф акумулаторен • [RO] Polizor unghiular cu acumulator



ART.NO. BARCODE
030166 3800972027954

CORDLESS DRILL & ANGLE GRINDER

RDP-CDLCAG03

• [BG] Бормашина и ъглошлайф акумулаторен
• [RO] Set Polizor unghiular si bormasina



RAIDER
Pro

ART.NO. BARCODE
030168 3800972028494

CARBIDE MULTI WHEEL CUTTING DISC

RD

• [BG] Диск за ъглошлайф Carbide Multi Wheel
• [RO] Disc debitare multmaterial cu carbura 7



ART.NO. BARCODE
160156 3800972029064

FLAP DISC ZIRCONIA

RD

• [BG] Диск ламелен Zirconia • [RO] Disc circular cu lamele smirghel



ART.NO. BARCODE
164136 3800972029071

TILE VIBRATOR LEVELING MACHINE

RD-TV01

• [BG] Вибратор за плочки • [RO] Masina de Nivelare Vibrator Tile



ART.NO. BARCODE
030167 3800972028432

CORDLESS POLISHER

RD-CPC07

• [BG] Полирмашина • [RO] Polisher



ART.NO. BARCODE
030171 3800972030107

BATTERY

RD

• [BG] Батерия • [RO] Акумулятор



ART.NO. BARCODE
131166 3800972027961

CORDLESS DRILL

4949-CDL27

• [BG] Бормашина акумулаторна • [RO] Masina de gaurit si insurubat



ART.NO. BARCODE
030149 3800972008946

CORDLESS DRILL

RDP-CDL09T

• [BG] Бормашина акумулаторна • [RO] Masina de gaurit si insurubat



RAIDER®
Pro

ART.NO. BARCODE
030125 3800123167324

CORDLESS DRILL

RDP-CDL26

• [BG] Бормашина акумулаторна • [RO] Masina de gaurit si insurubat

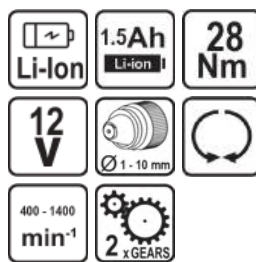

RAIDER®
Pro

ART.NO. BARCODE
030148 3800972008717

CORDLESS RATCHET WRENCH

RDP-RW01

• [BG] Тресчотка акумулаторна • [RO] Cheie cu clichet



ART.NO. BARCODE
030150 3800972009875

RAIDER®
Pro

CORDLESS JIG SAW

RD-RS39Y

• [BG] Прободен трион акумулаторен • [RO] Fierastrau pendular



ART.NO. BARCODE
060139 3800972034518

CORDLESS RECIPROCATING SAW

RD-RS31

• [BG] Трион саблен акумулаторен • [RO] Fierastrau sabie



ART.NO.	BARCODE
050130	3800972015272

BATTERY

3A RD-CDL26,27,09,RS31,RW01

• [BG] Батерия • [RO] Acumulator



ART.NO.	BARCODE
131154	3800972008755

BATTERY

3A RD-RW01, CDL09T, 26, 27

• [BG] Батерия • [RO] Acumulator



ART.NO.	BARCODE
131155	3800972009899

CHARGER FOR CORDLESS DRILL

3A RD-CDL09T & RD-CDL26

• [BG] Зарядно • [RO] Incarcator rapid



ART.NO.	BARCODE
039705	3800972008748

SET 12V CORDLESS DRILL 2 SPEED & HEX IMPACT DRIVER

RD-CDIDL01Y

• [BG] Бормашина и винтоверт ударен
• [RO] Set bormasina + surubelnita cu impact

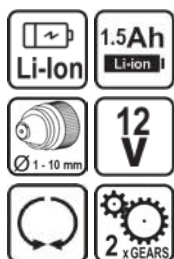

ART.NO.	BARCODE
030158	3800972016507

BATTERY

3A RD-CDIDL01Y,RS39Y, RW01Y, CDL26Y

• [BG] Батерия • [RO] Acumulator



ART.NO.	BARCODE
131173	3800972034501

CHARGER FOR CORDLESS SET

3A RD-CDIDLO1 GT21

• [BG] Зарядно • [RO] Incarcator rapid



ART.NO.	BARCODE
032131	3800972019447

BRUSHLESS CORDLESS DRILL

RD-BCDL39

• [BG] Бормашина безчеткова • [RO] Masina de gaurit si insurubat



ART.NO.	BARCODE
030189	3800972033542

BATTERY

3A RD-BCDL39

• [BG] Батерия • [RO] Acumulator



ART.NO.	BARCODE
030190	3800972033559

CHARGER 16V

3A RD-BCDL39

• [BG] Зарядно • [RO] Incarcator



ART.NO.	BARCODE
030191	3800972033566

CORDLESS BRUSHLESS PRUNING SHEARS

RD-PSH02

• [BG] Ножица акумулаторна безчеткова • [RO] Foarfeca electrica de gradina



ART.NO.	BARCODE
075725	3800972025462

BATTERY

3A RD-PSH02

• [BG] Батерия • [RO] Acumulator



ART.NO.	BARCODE
131165	3800972025493

CHARGER 16V FOR PRUNING SHEARS

3A RD-PSH02

- [BG] Зарядно 16V за лозарска ножица
- [RO] Incarcator 16V pentru Foarfeca de gradina



ART.NO. BARCODE
039715 3800972025509

CORDLESS HAMMER DRILL-DRIVER

RD-CDL38

- [BG] Бормашина ударна • [RO] Masina de gaurit cu percutie



ART.NO. BARCODE
030184 3800972031753

BATTERY

3A RD-CDL38

- [BG] Батерия 18V • [RO] Акумулятор



ART.NO. BARCODE
131171 3800972031760

CORDLESS DRILL

RD-CDL29

- [BG] Бормашина акумулаторна • [RO] Masina de gaurit si insuruba



ART.NO. BARCODE
030157 3800972016484

CORDLESS IMPACT WRENCH

RD-CIW01

- [BG] Гайковерт акумулаторен • [RO] Masina insurubat cu impact

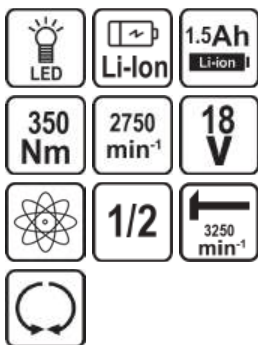

ART.NO. BARCODE
030146 3800972005068

CORDLESS JIG SAW

SOLO RD-JSL01

- [BG] Прободен трион акумулаторен • [RO] Fierastrau pendular



ART.NO. BARCODE
050132 3800972016514

CORDLESS CIRCULAR

SOLO RD-CSL01

• [BG] Циркулярен акумулаторен • [RO] Cordless Circular Saw

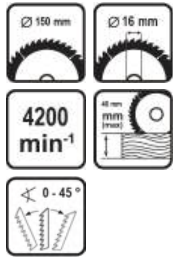

ART.NO. BARCODE
052112 3800972016521

CORDLESS RECIPROCATING SAW

SOLO RD-RSL01

• [BG] Трион саблен акумулаторен • [RO] Fierastrau sabie



ART.NO. BARCODE
050133 3800972016538

CORDLESS GRASS TRIMMER

RD-GTL22

• [BG] Комплект Косачка-тример • [RO] Set pentru taiere iarba



ART.NO. BARCODE
075540 3800972005143

CORDLESS GRASS TRIMMER

SOLO RD-GTL22

• [BG] Косачка-тример • [RO] Trimmer pentru gazon



ART.NO. BARCODE
075528 3800123174186

REFILL PACK WITH 10 SAFETY PLASTIC BLADES

3A RD-GTL22

• [BG] Ножчета 10 бр. за акумулаторен тример • [RO] RD-GTL22



ART.NO. BARCODE
110252 3800123174353

DISC WITH 10 SAFETY PLASTIC BLADE

RD-GTL22

• [BG] Диск с ножчета 10 бр
• [RO] Set disc si 10 lame plastic pentru trimmer iarba



ART.NO. BARCODE
110253 3800123174360

CORDLESS HEDGE TRIMMER

RD-HTL04

• [BG] Комплект Храсторез • [RO] Set pentru taiere gard viu

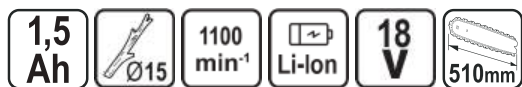

ART.NO. 075541
BARCODE 3800972005150

CORDLESS HEDGE TRIMMER

SOLO RD-HTL04

• [BG] Храсторез • [RO] Set pentru taiere gard viu

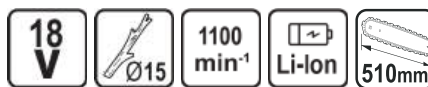

ART.NO. 075704
BARCODE 3800123174193

CORDLESS BLOWER

RD-CBL04

• [BG] Комплект Уред за обдухване • [RO] Set suflanta de gradina



ART.NO. 075542
BARCODE 3800972005167

CORDLESS BLOWER

SOLO RD-CBL04

• [BG] Уред за обдухване за 18V • [RO] Suflanta frunze



ART.NO. 075530
BARCODE 3800123174209

BATTERY 18V

FOR RD-GTL22 RD-HTL04 RD-CBL04 CDL25

• [BG] Батерия за акум. машини 18V • [RO] Acumulator

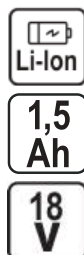

ART.NO. 131143
BARCODE 3800123174339

BATTERY 18V

RD

• [BG] Батерия за акум. машини 18V • [RO] Acumulator

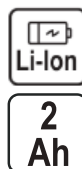

ART.NO. 131157
BARCODE 3800972016545

BATTERY

RD

• [BG] Батерия за акум. машини 18V • [RO] Acumulator



ART.NO.	BARCODE
131158	3800972016552

SYSTEM STARTER KIT

RD

• [BG] Комплект батерия и зарядно • [RO] R18 Set incarcator si acumulator



ART.NO.	BARCODE
032130	3800972016569

CHARGER FOR CORDLESS MACHINES

3A RD-GTL22 RD-HTL04 RD-CBL04

• [BG] Зарядно за акум. машини • [RO] Incarcator



ART.NO.	BARCODE
032122	3800123174346

RAPID CHARGER FOR CORDLESS MACHINES

3A RD-GTL22 RD-HTL04 RD-CBL04

• [BG] Бързо зарядно • [RO] Incarcator rapid



ART.NO.	BARCODE
032123	3800123174377

CORDLESS GRASS & SHRUB SHEARS

RD-GSSL03

• [BG] Ножица за трева и храсти • [RO] Foarfeca electrica pentru iarba



ART.NO.	BARCODE
075533	3800972030954

CORDLESS GRASS & SHRUB SHEARS

RD-GSSL04

• [BG] Ножица за трева и храсти • [RO] Foarfeca electrica pentru iarba

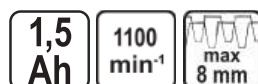

ART.NO.	BARCODE
075551	3800972030961

DRILL PLATE CUTTER ATTACHMENT

RD

- [BG] Приставка за бормашина за рязане на ламарина
- [RO] Adaptor taiere tabla pentru borma



ART.NO. 138003
 BARCODE 3800972027619

ELECTRIC DRILL

RDP-ID43 BLACK EDITION

- [BG] Бормашина
- [RO] Masina de gaurit si insurubat 450W RDP-ID43 Black Edition



RAIDER®
Pro

ART.NO. 010202
 BARCODE 3800972015371

IMPACT DRILL

RDP-ID28

- [BG] Бормашина
- [RO] Masina de gaurit cu percutie



RAIDER®
Pro

ART.NO. 010130
 BARCODE 3800123162435

IMPACT DRILL

RDP-ID46

- [BG] Бормашина
- [RO] Masina de gaurit cu percutie



RAIDER®
Pro

ART.NO. 010203
 BARCODE 3800972026872

IMPACT DRILL

RDP-ID42 BLACK EDITION

- [BG] Бормашина
- [RO] Masina de gaurit cu percutie



RAIDER®
Pro

ART.NO. 010201
 BARCODE 3800972015364

IMPACT DRILL

RDP-ID31

- [BG] Бормашина
- [RO] Masina de gaurit cu percutie



RAIDER®
Pro

ART.NO. 010133
 BARCODE 3800123163586

IMPACT DRILL

RD-ID40

• [BG] Бормашина • [RO] Masina de gaurit cu percutie



ART.NO. BARCODE
010140 3800972005471

IMPACT DRILL

RD-ID45

• [BG] Бормашина • [RO] Masina de gaurit cu percutie



ART.NO. BARCODE
010145 3800972026865

IMPACT DRILL

RD-ID36

• [BG] Бормашина • [RO] Masina de gaurit cu percutie



ART.NO. BARCODE
010139 3800972001183

IMPACT DRILL

RD-ID44

• [BG] Бормашина • [RO] Masina de gaurit cu percutie



ART.NO. BARCODE
010142 3800972018891

BENCH DRILL

RDP-BD04

• [BG] Бормашина настолна
• [RO] Masina de gaurit fixa



RAIDER
Pro

ART.NO. BARCODE
011104 3800123108693

BENCH DRILL

RDP-BD05

• [BG] Бормашина настолна
• [RO] Masina de gaurit fixa



RAIDER
Pro

ART.NO. BARCODE
011105 3800972018457

BENCH DRILL

RDP-BD02

- [BG] Бормашина настолна
- [RO] Masina de gaurit fixa



RAIDER®
Pro

ART.NO. BARCODE
011102 3800123123122

BENCH DRILL

RDP-BD03

- [BG] Бормашина настолна
- [RO] Masina de gaurit fixa



RAIDER®
Pro

ART.NO. BARCODE
011103 3800123124860

CORDED DRILL DRIVER

RD-CDD07

- [BG] Винтоверт електрически
- [RO] Masina de gaurit si insurubat



ART.NO. BARCODE
073108 3800972016446

CORDED DRILL DRIVER

RD-CDD08

- [BG] Винтоверт електрически
- [RO] Masina de gaurit si insurubat



ART.NO. BARCODE
073109 3800972016453

CORDED DRILL DRIVER

RD-CDD04

- [BG] Винтоверт електрически
- [RO] Masina de gaurit si insurubat



ART.NO. BARCODE
073105 3800972004221

CORDED DRILL DRIVER

RD-CDD03

- [BG] Винтоверт електрически
- [RO] Masina de gaurit si insurubat



ART.NO. BARCODE
073104 3800123167539

CORDED DRILL DRIVER

RDP-CDD02

• [BG] Винтоверт електрически • [RO] Masina de gaurit si insurubat



RAIDER®
Pro

ART.NO. BARCODE
073103 3800123166075

CORDED DRILL DRIVER

RDP-CDD09

• [BG] Винтоверт електрически • [RO] Masina de gaurit si insurubat



RAIDER®
Pro

ART.NO. BARCODE
073302 3800972023659

DRYWALL SCREWDRIVER

RD-ES46

• [BG] Винтоверт за гипсокартон • [RO] Surubelnita electrica pentru rigips



ART.NO. BARCODE
073101 3800123163616

DRYWALL SCREWDRIVER

RD-ES48

• [BG] Винтоверт за гипсокартон • [RO] Surubelnita electrica pentru rigips

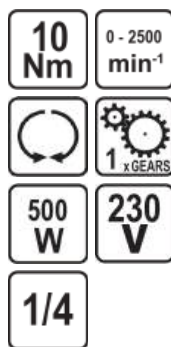

ART.NO. BARCODE
073110 3800972028951

DRYWALL SCREWDRIVER

RD-ES47

• [BG] Винтоверт за гипсокартон • [RO] Surubelnita electrica pentru rigips



ART.NO. BARCODE
073107 3800972010642

IMPACT WRENCH

RD-EIW07

• [BG] Гайковерт ударен • [RO] Pistol electric de impact



ART.NO. BARCODE
073206 3800972016385

IMPACT WRENCH

RD-EIW09

• [BG] Гайковерт ударен • [RO] Pistol electric de impact



ART.NO. BARCODE
073209 3800972031869

IMPACT WRENCH

RD-EIW08

• [BG] Гайковерт ударен • [RO] Pistol electric de impact



ART.NO. BARCODE
073208 3800972026537

IMPACT WRENCH

RD-EIW04

• [BG] Гайковерт ударен • [RO] Pistol electric de impact



ART.NO. BARCODE
073203 3800972002555

IMPACT WRENCH

RD-EIW05

• [BG] Гайковерт ударен • [RO] Pistol electric de impact



ART.NO. BARCODE
073204 3800972002562

ROTARY HAMMER

RD-HD53

• [BG] Перфоратор • [RO] Ciocan rotopercurator



ART.NO. BARCODE
013135 3800972009189

ROTARY HAMMER

RDP-HD64 BLACK EDITION

• [BG] Перфоратор • [RO] Ciocan rotopercurator



ART.NO. BARCODE
030348 3800972045088

RAIDER®
Pro

ROTARY HAMMER

RD-HD54

• [BG] Перфоратор • [RO] Ciocan rotopercurator



ROTARY HAMMER

RD-HD40

• [BG] Перфоратор • [RO] Ciocan rotopercurator



ROTARY HAMMER

RD-HD62

• [BG] Перфоратор • [RO] Ciocan rotopercurator



ROTARY HAMMER

RD-HD38

• [BG] Перфоратор • [RO] Ciocan rotopercurator



ROTARY HAMMER

RDP-HD63

• [BG] Перфоратор • [RO] Ciocan rotopercurator



ROTARY HAMMER

RDP-HD60

• [BG] Перфоратор • [RO] Ciocan rotopercurator



ROTARY HAMMER

RD-HD51

• [BG] Перфоратор • [RO] Ciocan rotopercutor



ART.NO. 012105
BARCODE 3800972008434

ROTARY HAMMER

RDP-HD05S

• [BG] Перфоратор • [RO] Ciocan rotopercutor



ART.NO. 012101
BARCODE 3800123124785

ROTARY HAMMER

RDP-HD12H

• [BG] Перфоратор • [RO] Ciocan rotopercutor



ART.NO. 012103
BARCODE 3800123153884

ROTARY HAMMER

RDP-HD65 BLACK EDITION

• [BG] Перфоратор • [RO] Ciocan rotopercutor



ART.NO. 030349
BARCODE 3800972045095

ROTARY HAMMER

RD-HD52

• [BG] Перфоратор • [RO] Ciocan rotopercutor



ART.NO. 013134
BARCODE 3800972008915

ROTARY HAMMER

RD-HD46

• [BG] Перфоратор • [RO] Ciocan rotopercutor

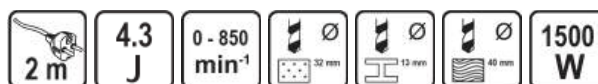

ART.NO. 013132
BARCODE 3800123174841

ROTARY HAMMER

RD-HD47

• [BG] Перфоратор • [RO] Ciocan rotopercutor



ART.NO. BARCODE
013133 3800972001503

ROTARY HAMMER

RDP-HD35

• [BG] Перфоратор • [RO] Ciocan rotopercutor



ART.NO. BARCODE
013123 3800123165603

**RAIDER®
Pro**

ROTARY HAMMER

RDP-HD57

• [BG] Перфоратор • [RO] Ciocan rotopercutor



ART.NO. BARCODE
012203 3800972016460

**RAIDER®
Pro**

ROTARY HAMMER

RDP-HD56

• [BG] Перфоратор • [RO] Ciocan rotopercutor



**RAIDER®
Pro**

ART.NO. BARCODE
012202 3800972016187

ROTARY HAMMER

RDP-HD67 BLACK EDITION

• [BG] Перфоратор • [RO] Ciocan rotopercutor



**RAIDER®
Pro**

ART.NO. BARCODE
030351 3800972045118

ROTARY HAMMER

RDP-HD31

• [BG] Перфоратор • [RO] Ciocan rotopercutor



ART.NO. BARCODE
013112 3800123160844

**RAIDER®
Pro**

ROTARY HAMMER

RDP-HD58

• [BG] Перфоратор • [RO] Ciocan rotopercurtor



RAIDER®
Pro

ART.NO. BARCODE
013203 3800972028500

ROTARY HAMMER

RDP-HD30

• [BG] Перфоратор • [RO] Ciocan rotopercurtor

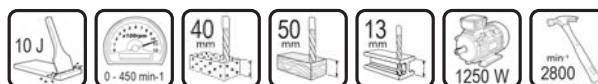

RAIDER®
Pro

ART.NO. BARCODE
013201 3800123158575

ROTARY HAMMER

RDP-HD55

• [BG] Перфоратор • [RO] Ciocan rotopercurtor



RAIDER®
Pro

ART.NO. BARCODE
013202 3800972009622

ROTARY HAMMER

RDP-HD59

• [BG] Перфоратор • [RO] Ciocan rotopercurtor



RAIDER®
Pro

ART.NO. BARCODE
013204 3800972028517

UNIVERSAL DUST EXTRACTOR MAX DRILL WITH HOSE VACUUM ADAPTER

RD

• [BG] Прахоуловител за пробиване • [RO] Extractor universal de praf



ART.NO. BARCODE
138001 3800972023727

UNIVERSAL DUST EXTRACTOR MAX DRILL WITH HOSE VACUUM ADAPTER

RD

• [BG] Прахоуловител за пробиване • [RO] Extractor universal de praf



ART.NO. BARCODE
138002 3800972023734

DEMOLITION HAMMER

RDP-DH03

• [BG] Къртач • [RO] Ciocan demolator



7,5 kg AVS



RAIDER®
Pro

ART.NO. BARCODE
012204 3800972016477

DEMOLITION HAMMER

RDP-DH05

• [BG] Къртач • [RO] Ciocan demolator



RAIDER®
Pro

ART.NO. BARCODE
013139 3800972035096



DEMOLITION HAMMER

RD-DH02

• [BG] Къртач • [RO] Ciocan demolator

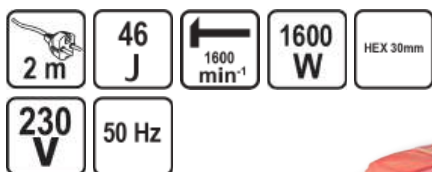

230 V 50 Hz



ART.NO. BARCODE
013137 3800972016347

DEMOLITION HAMMER

RDP-DH04

• [BG] Къртач • [RO] Ciocan demolator



RAIDER®
Pro

ART.NO. BARCODE
013138 3800972035072



ANGLE GRINDER HANDLE 125 MM

RD

• [BG] Дръжка за ъглошлиф • [RO] Maner pentru polizor unghiular

M8/
L10



ART.NO. BARCODE
139502 3800972014923

QUICK-LOCKING NUT

RDP

• [BG] Гайка бързозатягаща • [RO] Mandrina rapida pentru polizor unghiular

Ø115-
Ø230

M14



RAIDER®
Pro

ART.NO. BARCODE
139506 3800972039018

ANGLE GRINDER

RDP-AG68

• [BG] Ъглошлайф • [RO] Polizor unghiular



RAIDER®
Pro

ART.NO.	BARCODE
020306	3800972023086

ANGLE GRINDER

RDP-AG42 BLACK EDITION

• [BG] Ъглошлайф • [RO] Polizor unghiular



RAIDER®
Pro

ART.NO.	BARCODE
020143	3800123166839

ANGLE GRINDER

RDP-AG80 BLACK EDITION

• [BG] Ъглошлайф • [RO] Polizor unghiular



RAIDER®
Pro

ART.NO.	BARCODE
020150	3800972034532

ANGLE GRINDER

RDP-AG79 BLACK EDITION

• [BG] Ъглошлайф • [RO] Polizor unghiular



ART.NO.	BARCODE
020151	3800972034549

RAIDER®
Pro

ANGLE GRINDER

RDP-AG43 BLACK EDITION

• [BG] Ъглошлайф • [RO] Polizor unghiular



RAIDER®
Pro

ART.NO.	BARCODE
020144	3800123166822

ANGLE GRINDER

RDP-AG67

• [BG] Ъглошлайф • [RO] Polizor unghiular



RAIDER®
Pro

ART.NO.	BARCODE
020305	3800972020245

ANGLE GRINDER

RDP-AG75 BLACK EDITION

• [BG] Ъглошлайф • [RO] Polizor unghiular



RAIDER®
Pro

ART.NO. BARCODE
020307 3800972032521

ANGLE GRINDER

RDP-AG63 BLACK EDITION

• [BG] Ъглошлайф • [RO] Polizor unghiular



RAIDER®
Pro

ART.NO. BARCODE
020303 3800972015135

ANGLE GRINDER

RDP-AG64 BLACK EDITION

• [BG] Ъглошлайф • [RO] Polizor unghiular



RAIDER®
Pro

ART.NO. BARCODE
020304 3800972015142

ANGLE GRINDER

RDP-AG21Z

• [BG] Ъглошлайф • [RO] Polizor unghiular



RAIDER®
Pro

ART.NO. BARCODE
020118 3800123122552

ANGLE GRINDER

RDP-AG65L BLACK EDITION

• [BG] Ъглошлайф • [RO] Polizor unghiular



RAIDER®
Pro

ART.NO. BARCODE
020401 3800972015159

ANGLE GRINDER

RD-AG66

• [BG] Ъглошлайф • [RO] Polizor unghiular



ART.NO. BARCODE
020154 3800972018860

ANGLE GRINDER

RD-AG70

• [BG] Ъглошлайф • [RO] Polizor unghiular



230 V



ART.NO. BARCODE
020155 3800972027640

ANGLE GRINDER

RD-AG34B

• [BG] Ъглошлайф • [RO] Polizor unghiular

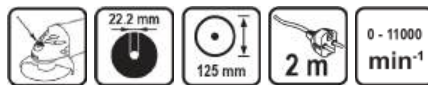

650 W

230 V

II



ART.NO. BARCODE
020136 3800123162466

ANGLE GRINDER

RD-AG84

• [BG] Ъглошлайф • [RO] Polizor unghiular

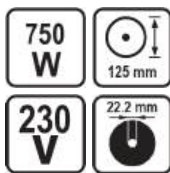

ART.NO. BARCODE
020156 3800972046009

ANGLE GRINDER

RD-AG60

• [BG] Ъглошлайф • [RO] Polizor unghiular



750 W

230 V

II



ART.NO. BARCODE
020153 3800972009868

ANGLE GRINDER

RD-AG51

• [BG] Ъглошлайф • [RO] Polizor unghiular



750 W

230 V

II



ART.NO. BARCODE
020149 3800972000780

ANGLE GRINDER

RD-AG36

• [BG] Ъглошлайф • [RO] Polizor unghiular



850 W

230 V

II



ART.NO. BARCODE
020138 3800123162480

ANGLE GRINDER

RD-AG44T

• [BG] Ъглошлайф • [RO] Polizor unghiular

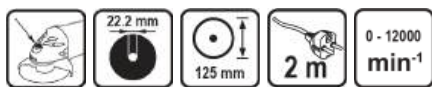

900
W

230
V

II



ART.NO. BARCODE
020145 3800123167355

ANGLE GRINDER

RD-AG76

• [BG] Ъглошлайф • [RO] Polizor unghiular

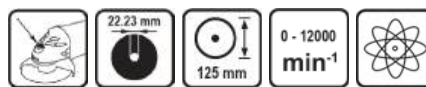

900
W

230
V

II



ART.NO. BARCODE
020148 3800972032538

ANGLE GRINDER

RD-AG37D

• [BG] Ъглошлайф • [RO] Polizor unghiular



1200
W

230
V

II



ART.NO. BARCODE
020139 3800123162497

ANGLE GRINDER

RD-AG39D

• [BG] Ъглошлайф • [RO] Polizor unghiular



1150
W

230
V

II



ART.NO. BARCODE
020140 3800123162534

ANGLE GRINDER

RD-AG54

• [BG] Ъглошлайф • [RO] Polizor unghiular



1200
W

230
V

II



ART.NO. BARCODE
020152 3800972000810

DUST EXTRACTION GUARD WITH ADAPTERS

RD

• [BG] Предпазител за прахоулавяне за ъглошлайф с адаптери
• [RO] Aparatoare de praf pentru polizor unghiular



ART.NO. BARCODE
139504 3800972023710

DUST EXTRACTION GUARD 180 MM WITH ADAPTERS

RD

- [BG] Предпазител за прахоулавяне за ъглошлайф
- [RO] Aparatoare de praf pentru polizor unghiular



ART.NO.	BARCODE
139507	3800972039544

45 DEGREE TILE CURRING ATTACHMENT

RD

- [BG] Приставка за рязане на плочки под 45°
- [RO] Accesoriu 45° pentru taiere placi ceramice cu polizor



ART.NO.	BARCODE
139510	3800972039575

TRIANGULAR TUBE BELT SANDER ATTACHMENT

RD

- [BG] Приставка триъгълна за лентово шлайфане на тръби
- [RO] Sistem triunghiular cu banda smirghel pt. polizor unghiular

760 x
40 mm



ART.NO.	BARCODE
139508	3800972039551

DUST EXTRACTION GUARD

RD

- [BG] Приставка за лентово пилене за ъглошлайф
- [RO] Aparatoare de praf pentru polizor unghiular

533 x
9 mm

533 x
30 mm



ART.NO.	BARCODE
139509	3800972039568

SANDING BELT

RD

- [BG] Шлифовъчна лента • [RO] Banda smirghel neperforat



ART.NO.	BARCODE	SIZE	GRIT
183127	3800972047235	760x40 mm	P60
183128	3800972047242	760x40 mm	P80
183129	3800972047259	760x40 mm	P120

SANDING BELT

RD

- [BG] Шлифовъчна лента • [RO] Banda smirghel neperforat



ART.NO.	BARCODE	SIZE	GRIT
183121	3800972047174	533x30 mm	P60
183122	3800972047181	533x30 mm	P80
183123	3800972047198	533x30 mm	P120
183124	3800972047204	533x9 mm	P60
183125	3800972047211	533x9 mm	P80
183126	3800972047228	533x9 mm	P120

ANGLE GRINDER

RD-AG10T

• [BG] Ъглошлайф • [RO] Polizor unghiular



1400
W

230
V

II



ART.NO. BARCODE
020107 3800123124617



ANGLE GRINDER

RD-AG77

• [BG] Ъглошлайф • [RO] Polizor unghiular



2000
W

230
V

II



ART.NO. BARCODE
020205 3800972032545

ANGLE GRINDER

RD-AG55

• [BG] Ъглошлайф • [RO] Polizor unghiular



2350
W

230
V

II



ART.NO. BARCODE
020203 3800972000827

ANGLE GRINDER

RD-AG78

• [BG] Ъглошлайф • [RO] Polizor unghiular



2400
W

230
V

II



ART.NO. BARCODE
020206 3800972032552

WALL CHASER

RD-WCH04

• [BG] Фреза за канали • [RO] Masina de frezat caneluri

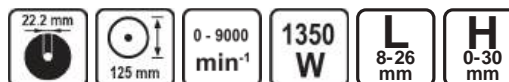

230
V

II



ART.NO. BARCODE
020904 3800972034631

WALL CHASER

RDP-WCH03

• [BG] Фреза за канали • [RO] Masina de frezat caneluri

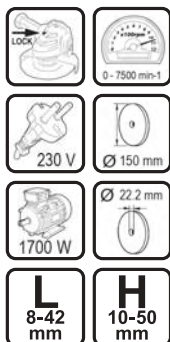

RAIDER
Pro

ART.NO. BARCODE
020902 3800972032514

WALL CHASER

RDP-WCH02

• [BG] Фреза за канали • [RO] Masina de frezat caneluri

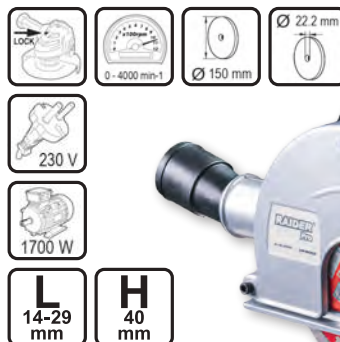

RAIDER
Pro

ART.NO. BARCODE
020901 3800972022614

WALL CHASER

RDP-WCH05

• [BG] Фреза за канали • [RO] Masina de frezat caneluri



RAIDER
Pro

ART.NO. BARCODE
020905 3800972039278

JIG SAW

RDP-JS25

• [BG] Прободен трион • [RO] Fierastrau pendular



RAIDER
Pro

ART.NO. BARCODE
050119 3800123167232

JIG SAW

RDP-JS21

• [BG] Прободен трион • [RO] Fierastrau pendular



RAIDER
Pro

ART.NO. BARCODE
050201 3800123159022

JIG SAW

RDP-JS26

• [BG] Прободен трион • [RO] Fierastrau pendular



РЕГ.
ОБОРОТИ

RAIDER
Pro

ART.NO. BARCODE
050120 3800123167249

JIG SAW

RD-JS31

• [BG] Прободен трион • [RO] Fierastrau pendular



ART.NO. BARCODE
050126 3800972009745

JIG SAW

RD-JS32

• [BG] Прободен трион • [RO] Fierastrau pendular



ART.NO. BARCODE
050127 3800972009844

JIG SAW

RD-JS33

• [BG] Прободен трион • [RO] Fierastrau pendular



ART.NO. BARCODE
050128 3800972009851

JIG SAW

RD-JS28

• [BG] Прободен трион • [RO] Fierastrau pendular



ART.NO. BARCODE
050125 3800972001190

JIG SAW

RDP-JS35

• [BG] Прободен трион • [RO] Fierastrau pendular

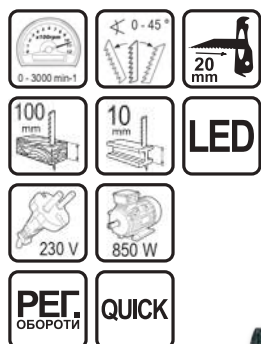

ART.NO. BARCODE
050206 3800972030091

**RAIDER®
Pro**

JIG SAW

RDP-JS34

• [BG] Прободен трион • [RO] Fierastrau pendular



ART.NO. BARCODE
050203 3800972016361

**RAIDER®
Pro**

RECIPROCATING SAW

RD-RS36

• [BG] Трион саблен • [RO] Fierastrau sabie



ART.NO.	BARCODE
050136	3800972026841

RECIPROCATING SAW

RD-RS38

• [BG] Трион саблен • [RO] Fierastrau sabie



ART.NO.	BARCODE
050138	3800972031876

RECIPROCATING SAW

RD-RS32

• [BG] Трион саблен • [RO] Fierastrau sabie



ART.NO.	BARCODE
050131	3800972016354

NIBBLER

RDP-NI01

• [BG] Harep • [RO] Foarfeca electrica



RAIDER®
Pro

ART.NO.	BARCODE
050141	3800972035126



JIGSAW BLADES

• [BG] Нож за прободен трион • [RO] Lama fierastrau pendular

ART.NO.	BARCODE	MODEL	USE	INFO	PICTURE
155524	3800972033764	RD-6T341HM	UNIVERSAL	130 mm 4.0 mm 6TPI	
155525	3800972033771	RD-6T541HM	UNIVERSAL	150 mm 4.0 mm 6TPI	
155411	3800123164200	RD-MT118G	METAL	T 76(50) 0.8 mm 2PCS	
155412	3800123164217	RD-MT118AF	METAL	T 76(50) 1.2 mm 2PCS	
155529	3800972033818	RD-MT7186F	METAL	180 mm 1.0 mm 24TPI 2PCS	
155530	3800972033825	RD-MT7188F	METAL	180 mm 1.8 mm 14TPI 2PCS	
155417	3800972009684	RD-CT141HM	WOOD	T 100(75) 4.3 mm 1PCS	
155531	3800972033832	RD-WT101BIF	WOOD	80 mm 1.7 mm 15TPI 2PCS	
155532	3800972033849	RD-WT101BSP	WOOD	100 mm 2.5-1.2 mm 10-21TPI 2PCS	
155533	3800972033856	RD-WT101AI	WOOD	100 mm 1.7 mm 15TPI 2PCS	
155534	3800972033863	RD-WT301DL	WOOD	130 mm 4.0 mm 6TPI 2PCS	
155535	3800972033870	RD-WT544D	WOOD	150 mm 4.0 mm 6TPI 2PCS	
155536	3800972033887	RD-WT1044DP	WOOD	250 mm 4.0 mm 6TPI 2PCS	
155537	3800972033894	RD-WT234X	WOOD	116 mm 2-3 mm 8-12TPI 2PCS	
155538	3800972033900	RD-WT308B	WOOD	116 mm 2.2 mm 12TPI 2PCS	
155539	3800972033917	RD-LT101BM	WOOD	100 mm 2.0 mm 12TPI 2PCS	
155540	3800972033924	RD-LT301BM	WOOD	116 mm 2.0 mm 12TPI 2PCS	
155401	3800123164101	RD-WT119B0	WOOD	T 76(50) 2.0 mm 2PCS	
155402	3800123164118	RD-WT111C	WOOD	T 100(75) 3.0 mm 2PCS	
155403	3800123164125	RD-WT144D	WOOD	T 100(75) 4.0 mm 2PCS	
155404	3800123164132	RD-WT244DS	WOOD	T 100(75) 4.0 mm 2PCS	
155405	3800123164149	RD-WT344D	WOOD	T 132(110) 4.0 mm 2PCS	
155406	3800123164156	RD-WT101A0	WOOD	T 76(50) 1.4 mm 2PCS	
155407	3800123164163	RD-WT101B	WOOD	T 100(75) 2.5 mm 2PCS	
155408	3800123164170	RD-WT101BR	WOOD	T 100(75) 2.5 mm 2PCS	
155409	3800123164187	RD-WT101D	WOOD	T 100(75) 4.0 mm 2PCS	
155410	3800123164194	RD-WT301CD	WOOD	T 116(90) 3.0 mm 2PCS	
155418	3800972009691	RD-WT344CB	WOOD	T 116(90) 2PCS	
155419	3800972009707	RD-WT744D	WOOD	T 180(155) 4.0 mm 2PCS	
209911	3800123107269	RD	WOOD	U 8TPI 5PCS. SET	

155413	3800123164224	RD	WOOD & METAL	T SHANK 5PCS. SET: RD-WT119B0 RD-WT144D RD-WT101B RD-WT111C RD-MT118A	
155414	3800123164231	RD	WOOD & METAL	T SHANK 10PCS. SET: RD-WT119B0 - 2 PCS RD-WT144D - 2 PCS RD-WT101B - 2 PCS RD-WT111C - 2 PCS RD-MT118A - 1 PCS RD-MT118G - 1 PCS	
155416	3800972009677	RD	WOOD & METAL	T 16 PCS. SET: T111C 8TPI X 4" HCS- 2 PCS T144D 6TPI X 4" HCS- 2 PCS T101B 10TPI X 4" HCS- 2 PCS T101BR 10TPI X 4" HCS- 2 PCS T123X 10/24TPI X 4" HSS- 1 PCS T118B 12TPI X 3" HSS- 2 PCS T118A 21TPI X 3" HSS- 3 PCS T119B0 12TPI X 3" HCS- 2 PCS	
155526	3800972033788	RD-WMT367XHM	WOOD & METAL	150 mm 3.6-5 mm 5-7TP	
155527	3800972033795	RD-WNT345XF	WOOD & METAL	130 mm 2.4-5 mm 5-11TPI 2PCS	
155528	3800972033801	RD-WNT318VF	WOOD & PLASTICS	130 mm 1.8-2.6 mm 10-14TPI 2PCS	
155541	3800972033931	RD-WNT323MF	WOOD & PLASTICS	130 mm 2-3 mm 8-12TPI 2PCS	

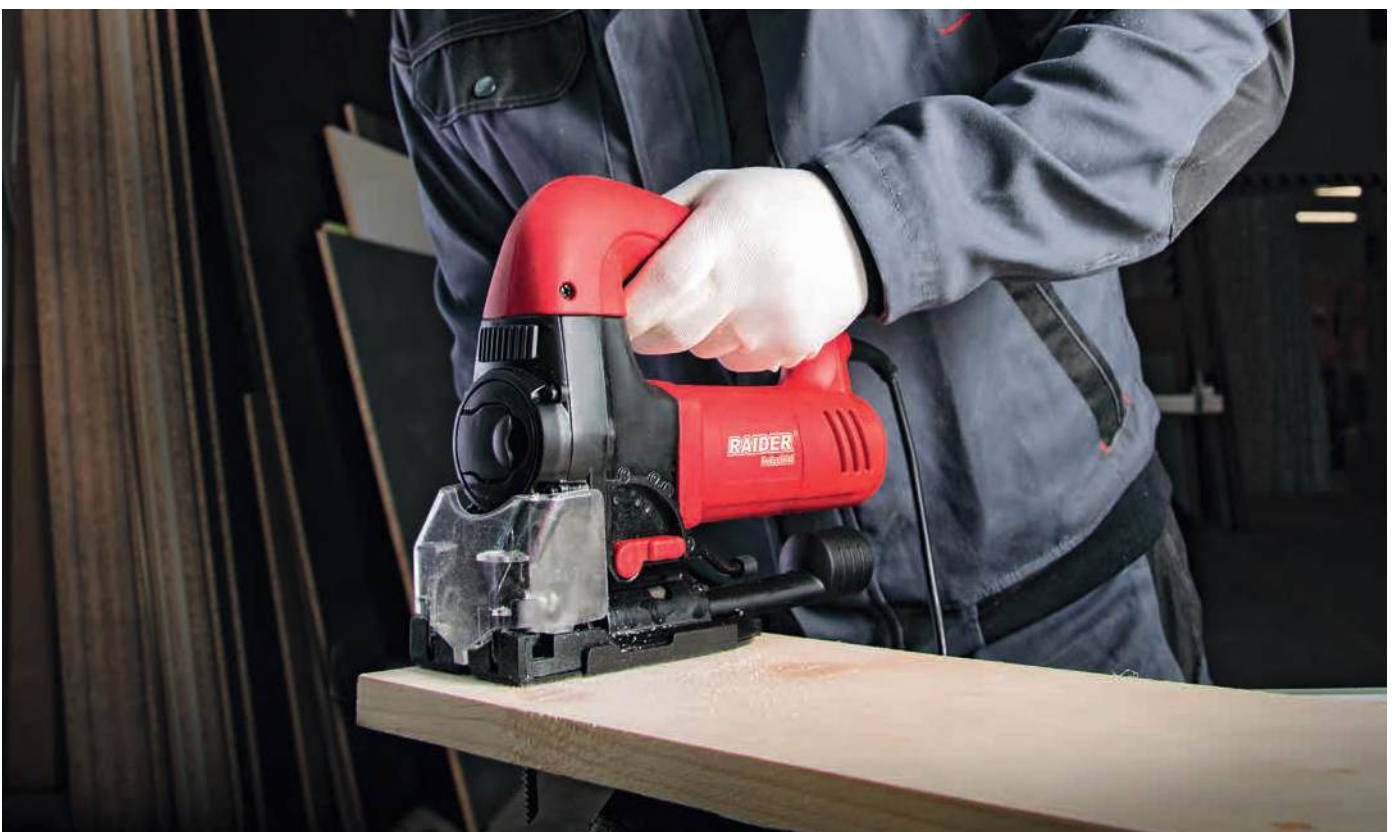

RECIPROCATING SAW BLADE

• [BG] Нож за саблен трион • [RO] Lama fierastrau sabie

ART.NO.	BARCODE	MODEL	USE	INFO	PICTURE
155506	3800972033580	RD-MS930HM	METAL	150 mm 3 mm 8TPI	
155507	3800972033597	RD-MS1130HM	METAL	228mm 3mm 8TPI	
155508	3800972033603	RD-MS1230HM	METAL	300 mm 3 mm 8TPI	
155503	3800123164255	RD-MS1122EF	METAL	225x19x0.9 mm (1.4 mm) 2PCS	
155509	3800972033610	RD-GS641HM	UNIVERSAL	150 mm 4,3 mm 6TPI	
155510	3800972033627	RD-GS940HM	UNIVERSAL	150 mm 4,3 mm 6TPI	
155511	3800972033634	RD-GS1140HM	UNIVERSAL	228 mm 4,3 mm 6TPI	
155512	3800972033641	RD-WNS950HM	WOOD & PLASTICS	150 mm 5 mm 5TPI	
155513	3800972033658	RD-WNS1150HM	WOOD & PLASTICS	228 mm 5 mm 5TPI	
155514	3800972033665	RD-WNS1250HM	WOOD & PLASTICS	300 mm 5 mm 5TPI	
155515	3800972033672	RD-WMS956XHM	WOOD & METAL	150 mm 3-4 mm 6-8TPI	
155516	3800972033689	RD-WMS1156XHM	WOOD & METAL	228 mm 3-4 mm 6-8TPI	
155517	3800972033696	RD-WMS1256XHM	WOOD & METAL	300 mm 3-4 mm 6-8TPI	
155422	3800972009738	RD-BIMS1122VF	WOOD & METAL	225x19x0.9 mm (1.8-2.6 mm) 2PCS	
155502	3800123164248	RD-WS1531L	WOOD	240x19x1.5mm (5.0 mm) 2PCS	
155523	3800972033757	RD-WS1231L	WOOD	300 mm 5 mm 5TPI 2PCS	
155420	3800972009714	RD-WS644D	WOOD	150x1.25 mm (4.3 mm) 2PCS	
155421	3800972009721	RD-WS1111K	WOOD	225x1.25 mm (8.5 mm) 2PCS	
155521	3800972033733	RD-BS1543HM	BRICKS	240 mm 12,7 mm 2TPI	
155522	3800972033740	RD-BS1243HM	BRICKS	305 mm 12,7 mm 2TPI	
155415	3800123173813	RD-RS2243	BRICKS	455x50x1.5 mm TCT 2TPI (12.7 mm)	
155518	3800972033702	RD-ACS1141HM	BRICKS	228mm 8,5 mm 3TPI	
155519	3800972033719	RD-ACS1241HM	BRICKS	300 mm 8,5 mm 3TPI	
155520	3800972033726	RD-ACS2041HM	BRICKS	400 mm 12,7 mm 2TPI	

OSCILLATING MULTI-TOOL

RD-OMT04

- [BG] Многофункционален инструмент
- [RO] Unealta multifunctionala oscilanta



ART.NO. BARCODE
050137 3800972030985

OSCILLATING MULTI-TOOL

RDP-OMT05

- [BG] Многофункционален инструмент
- [RO] Unealta multifunctionala oscilanta



RAIDER Pro

ART.NO. BARCODE
050140 3800972035089

SAW BLADE FOR OMT

RD

- [BG] Нож за многофункционален инструмент
- [RO] Rezerva uenalta multifunctionalataiere lemn

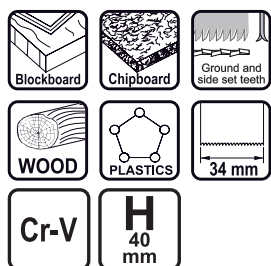

ART.NO. BARCODE
155601 3800123164507

SAW BLADE FOR OMT

RD

- [BG] Нож за многофункционален инструмент
- [RO] Rezerva uenalta multifunctionala lemn si meta

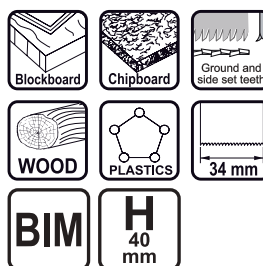

ART.NO. BARCODE
155602 3800123164514

SAW BLADE FOR OMT

RD

- [BG] Нож за многофункционален инструмент
- [RO] Disc uenalta multifunctionala pt.lemn

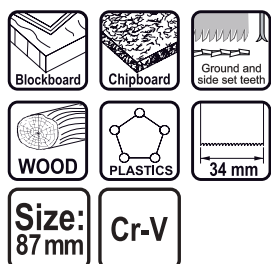

ART.NO. BARCODE
155603 3800123164521

SAW BLADE FOR OMT

RD

- [BG] Нож за многофункционален инструмент
- [RO] Disc uenalta multifunctionala pt.lemn si metal

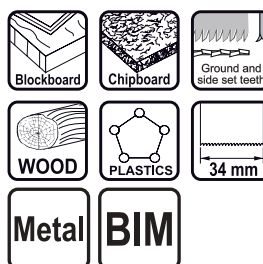

ART.NO. BARCODE
155604 3800123164538

SCRAPER FOR OMT

RD

- [BG] Шабер за многофункционален инструмент
- [RO] Rezerva unealta multifunctionaladaltuire

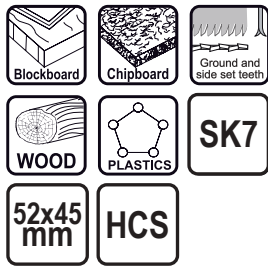

ART.NO. BARCODE
155605 3800123164545

SAW BLADE FOR OMT

RD

- [BG] Нож за многофункционален инструмент
- [RO] Disc unealta multifunctionala pt. Ceramica

85 mm
Carbide



ART.NO. BARCODE
155606 3800123164552

SANDING PLATE FOR OMT

RD

- [BG] Шлифовъчна плоча за многофункционален инструмент
- [RO] Rezerva unealta multifunctionala slefuire

80 mm
Carbide



ART.NO. BARCODE
155607 3800123164569

SANDING PLATE FOR OMT

RD

- [BG] Шлифовъчна плоча за многофункционален инструмент
- [RO] Suport unealta multifunctionala slefuire delta

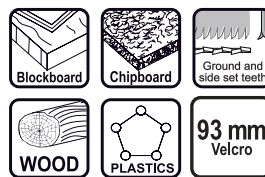

ART.NO. BARCODE
155608 3800123164576

SANDING SHEETS FOR OMT 10 PCS. KIT

RD

- [BG] Шкурка за многофункционален инструмент
- [RO] Set smirghel unealta multifunctionala 10 buc

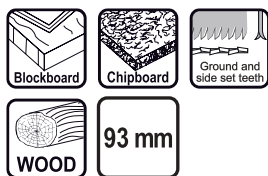

ART.NO. BARCODE
155609 3800123164583

ACCESSORIES FOR OSCILLATING MULTIFUNCTIONAL TOOL 10 PCS. KIT

RD

- [BG] Комплект аксесоари за многофункционален инструмент 10 части
- [RO] Set rezerva unealta multifunctionala



ART.NO. BARCODE
155610 3800123164613

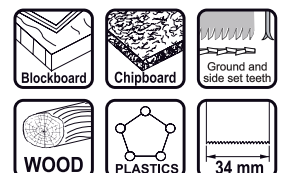

SANDER RD-SA26

• [BG] Виброшлайф • [RO] Slefuitor cu vibratii



ART.NO.	BARCODE
040115	3800972010413

SANDER 3IN1 MULTI RD-MSA30

• [BG] Шлайф 3в1 Multi • [RO] Slefuitor 3in1



ART.NO.	BARCODE
040410	3800972035850

SANDER RD-SA29

• [BG] Виброшлайф • [RO] Slefuitor cu vibratii



ART.NO.	BARCODE
040409	3800972035560

SANDER RD-SA28 BLACK EDITION

• [BG] Виброшлайф • [RO] Slefuitor cu vibratii

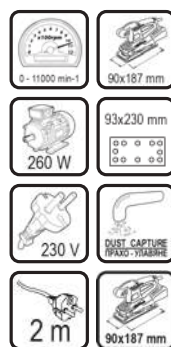

ART.NO.	BARCODE
040407	3800972026803

SANDER RD-SA08

• [BG] Виброшлайф • [RO] Slefuitor cu vibratii

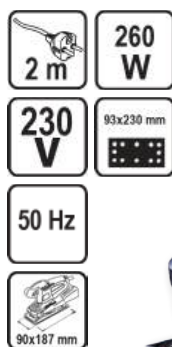

ART.NO.	BARCODE
040112	3800123160813

SANDER RD-SA19T

• [BG] Виброшлайф • [RO] Slefuitor cu vibratii

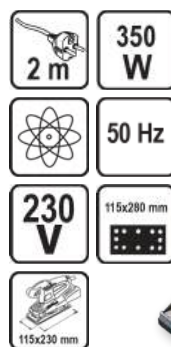

ART.NO.	BARCODE
040111	3800123151477

SANDER

RDP-SA27 BLACK EDITION

• [BG] Виброшлайф • [RO] Slefuitor cu vibratii



RAIDER
Pro

ART.NO.	BARCODE
040406	3800972025813

RANDOM ORBIT SANDER

RD-RSA06

• [BG] Ексцентършлайф • [RO] Slefuitor orbital



ART.NO.	BARCODE
040117	3800972023635

RANDOM ORBIT SANDER

RD-RSA08

• [BG] Ексцентършлайф • [RO] Slefuitor orbital



ART.NO.	BARCODE
040118	3800972030978

RANDOM ORBIT SANDER

RDP-RSA07 BLACK EDITION

• [BG] Ексцентършлайф • [RO] Slefuitor orbital



RAIDER
Pro

ART.NO.	BARCODE
040405	3800972025806

RANDOM ORBIT SANDER

RDP-RSA04

• [BG] Ексцентършлайф • [RO] Slefuitor orbital



RAIDER
Pro

ART.NO.	BARCODE
042201	3800123167256

BELT SANDER

RD-BS10

• [BG] Шлайф лентов • [RO] Slefuitor cu banda



ART.NO.	BARCODE
043108	3800972026827

BELT SANDER

RD-BS09

• [BG] Шлайф лентов • [RO] Slefuitor cu banda



ART.NO. BARCODE
043107 3800972026810

BELT SANDER

RD-BS12

• [BG] Шлайф лентов • [RO] Slefuitor cu banda



ART.NO. BARCODE
043109 3800972031852

BELT SANDER

RDP-BS11

• [BG] Шлайф лентов • [RO] Slefuitor cu banda



RAIDER®
Pro

ART.NO. BARCODE
043203 3800972026889

DRYWALL SANDER

RD-DS09

• [BG] Шлайфмашина за стени и тавани • [RO] Slefuit gips-carton



ART.NO. BARCODE
049911 3800972027923

DRYWALL SANDER

RD-DS08

• [BG] Шлайфмашина за стени и тавани
• [RO] Slefuit gips-carton



ART.NO. BARCODE
049910 3800972025714

DRYWALL SANDER

RD-DS06

• [BG] Шлайфмашина за стени и тавани
• [RO] Slefuit gips-carton



ART.NO. BARCODE
049906 3800972009165



DUST BAG FOR DRYWALL SANDER

FOR RD-DS06

- [BG] Торба за прах за шлайфмашина за стени и тавани
- [RO] Sac colector pentru slefuitor de pereti



ART.NO.	BARCODE
049908	3800972010178

DRYWALL SANDER

RD-DS07

- [BG] Шлайфмашина за стени и тавани
- [RO] Slefuit gips-carton



 Ø 225 mm	 2 m	 Length 1570 mm
 800 - 1750 min ⁻¹	 MAX. Length 1750 mm	
 750 W	 230 V	
 50 Hz		





ART.NO.	BARCODE
049909	3800972019737

WORK LIGHT

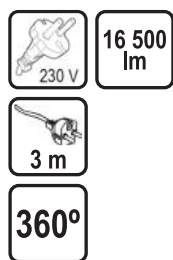
RDP-WL01

- [BG] Лампа работна • [RO] Lampa de lucru



 230 V	 16 500 lm
 3 m	
 360°	

RAIDER®
Pro

ART.NO.	BARCODE
710304	3800972035324

WORK LIGHT

RDP-WL02

- [BG] Лампа работна • [RO] Lampa de lucru



 20 V	 3300 lm
 USB	
 Dimmer	
 LED	

ART.NO.	BARCODE
710305	3800972035331

RAIDER®
Pro

TRIPOD FLEXIBLE

RDP-TF01

- [BG] Тринога съгваема • [RO] Trepied



 H 0,8-1,6 m

ART.NO.	BARCODE
710306	3800972035348

RAIDER®
Pro

TRIPOD FLEXIBLE

RDP-TF02

- [BG] Тринога съгваема • [RO] Trepied



 H 0,77-1,19 m

ART.NO.	BARCODE
710307	3800972035355

RAIDER®
Pro

SANDING DISC FOR SANDERS VELCRO

RD

• [BG] Шкурка VELCRO • [RO] Disc smirghel velcro micro-perforat



ART.NO.	BARCODE	SIZE	GRIT
180741	3800972028630	Ø180 mm	80
180742	3800972028647	Ø180 mm	100
180743	3800972028654	Ø180 mm	120
180744	3800972028661	Ø180 mm	150
180745	3800972028678	Ø180 mm	180

MESH DISC FOR LONG-NECK SANDERS VELCRO

RD

• [BG] Шкурка мрежеста VELCRO
• [RO] Disc plasa cu velcro pentru slefuitor tavan



ART.NO.	BARCODE	SIZE	GRIT
180747	3800972044159	Ø225 mm	80
180748	3800972044166	Ø225 mm	100
180749	3800972044173	Ø225 mm	120
180750	3800972044180	Ø225 mm	150
180751	3800972044197	Ø225 mm	180
180752	3800972044203	Ø225 mm	220
180753	3800972044210	Ø225 mm	240
180754	3800972044227	Ø225 mm	320

SANDING DISC FOR LONG-NECK SANDERS VELCRO

RD

• [BG] Шкурка VELCRO • [RO] Disc smirghel velcro micro-perforat



ART.NO.	BARCODE	SIZE	GRIT
180721	3800123166266	Ø225 mm	80
180724	3800123166723	Ø225 mm	100
180722	3800123166273	Ø225 mm	120
180723	3800123166280	Ø225 mm	150
180725	3800972002180	Ø225 mm	180
180746	3800972035676	Ø225 mm	220

TRIANGULAR SANDING SHEETS FOR LONG-NECK SANDERS VELCRO 5 PCS

RD

• [BG] Шкурка VELCRO триъгълна
• [RO] Set 5 coli smirghel VELCRO triunghiular

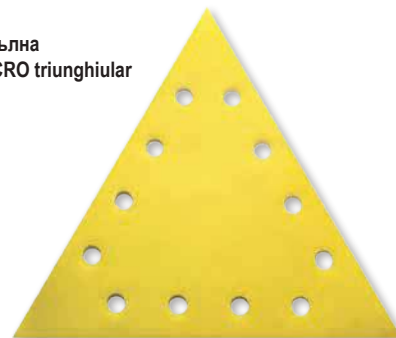

ART.NO.	BARCODE	SIZE	GRIT
180726	3800972003378	285 mm	80
180727	3800972003385	285 mm	100
180728	3800972003392	285 mm	120
180729	3800972003408	285 mm	150
180730	3800972003415	285 mm	180



POLISHER

RD-PC03

• [BG] Полирмашина • [RO] Polisher



ART.NO. BARCODE
045101 3800123124419

POLISHER

RD-PC06

• [BG] Полирмашина • [RO] Polisher

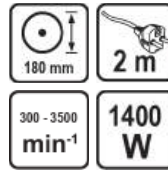

ART.NO. BARCODE
045106 3800972026896

POLISHER

RDP-PC07

• [BG] Полирмашина • [RO] Polisher



ART.NO. BARCODE
045107 3800972038134

DISC FOR POLISHER

FOR RDP-PC07

• [BG] Диск VELCRO за Полирмашина • [RO] Suport cauciu



ART.NO. BARCODE
045108 3800972038141

RAIDER®
Pro

RAIDER®
Pro

POLISHING FOAM PADS 7 PCS.

RD

• [BG] Полиращи гъби 7 бр.
• [RO] Set 7 discuri polisare



ART.NO. BARCODE
045109 3800972038158

POLISHING FOAM PADS 29 PCS.

RD

• [BG] Полиращи гъби 29 бр.
• [RO] Set 29 bureti pentru polish



ART.NO. BARCODE
045110 3800972041998

SCOTCH-BRITE DISC 19 PCS.

RD

• [BG] Скочбрайт дискове 19 бр.
• [RO] Set 19 bucati pasla abraziva



ART.NO. BARCODE
045111 3800972042001

POLISHER

RD-PC04T

• [BG] Полирмашина • [RO] Polisher



ART.NO. BARCODE
045102 3800123124167

RAIDER
Pro

DIE GRINDER

RDP-DG01

• [BG] Шлайф прав • [RO] Polizor drept



ART.NO. BARCODE
041602 3800972019683

RAIDER
Pro

BURNISHING MACHINE

RDP-BM01

• [BG] Шлайф ролков • [RO] Masina de slefuit

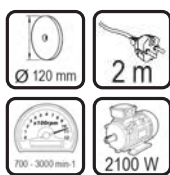

ART.NO. BARCODE
041601 3800972019676

RAIDER
Pro

POLISHING FLEECE WHEEL MIDDLE GRIT

FOR RDP-BM01

• [BG] Ролка филцова • [RO] Roata de slefuit granulatie medie pentru



ART.NO. BARCODE
155802 3800972019669

RAIDER
Pro

ROTARY RASP FILE 5PCS. SET

RD

• [BG] Борчета за дърво • [RO] Set 5 raspile pentru slefuit biax



ART.NO. BARCODE
159902 3800123121319

Ø6 5 WOOD
опашка pcs.

MOUNTED GRINDING POINT 5PCS. SET

RD

• [BG] Борчета абразивни • [RO] Set 5 pietre slefuit pentru bormasina



ART.NO. BARCODE
159903 3800123121104

Ø6 5 METAL
опашка pcs.

TUNGSTEN CARBIDE BURR

RDP

- [BG] Фрезер от волфрамов карбид
- [RO] Freza tip carbura

ART.NO.	BARCODE	TYPE	SIZE	PICTURE
154410	3800972047327	AX	06 x 16 06 mm	
154411	3800972047334	AX	08 x 20 06 mm	
154412	3800972047341	AX	010 x 20 06 mm	
154413	3800972047358	AX	012 x 25 06 mm	
154414	3800972047365	AX	014 x 25 06 mm	
154415	3800972047372	AX	016 x 25 06 mm	
154416	3800972047389	BX	06 x 16 06 mm	
154417	3800972047396	BX	08 x 20 06 mm	
154418	3800972047402	BX	010 x 20 06 mm	
154419	3800972047419	BX	012 x 25 06 mm	
154420	3800972047426	CX	06 x 16 06 mm	
154421	3800972047433	CX	08 x 20 06 mm	
154422	3800972047440	CX	010 x 20 06 mm	
154423	3800972047457	CX	012 x 25 06 mm	
154424	3800972047464	DX	08 x 07 06 mm	
154425	3800972047471	DX	010 x 09 06 mm	
154426	3800972047488	DX	012 x 10 06 mm	
154427	3800972047495	EX	08 x 13 06 mm	
154428	3800972047501	EX	010 x 16 06 mm	
154429	3800972047518	EX	012 x 20 06 mm	
154430	3800972047525	FX	08 x 18 06 mm	
154431	3800972047532	FX	010 x 20 06 mm	
154432	3800972047549	FX	012 x 25 06 mm	
154433	3800972047556	GX	08 x 17 06 mm	
154434	3800972047563	GX	010 x 20 06 mm	
154435	3800972047570	GX	012 x 25 06 mm	
154436	3800972047587	HX	08 x 20 06 mm	
154437	3800972047594	HX	010 x 25 06 mm	
154438	3800972047600	HX	012 x 32 06 mm	
154439	3800972047617	LX	08 x 22 06 mm	
154440	3800972047624	LX	010 x 25 06 mm	
154441	3800972047631	LX	012 x 28 06 mm	
154442	3800972047648	MX	08 x 17 06 mm	
154443	3800972047655	MX	010 x 20 06 mm	
154444	3800972047662	MX	012 x 25 06 mm	
154445	3800972047679	NX	08 x 08 06 mm	
154446	3800972047686	NX	010 x 10 06 mm	
154447	3800972047693	NX	012 x 13 06 mm	

MINI GRINDER SET

RD-CMG16

- [BG] Шлифовалка
- [RO] Set mini polizor drept



5000-30 000 min⁻¹

127 accessories



ART.NO. BARCODE
044116 3800972034778

MINI GRINDER SET

RD-MG14

- [BG] Шлифовалка • [RO] Set mini polizor drept



0 - 16000 min⁻¹

110 accessories

230V + 12V DC



ART.NO. BARCODE
044114 3800972034693

MINI GRINDER SET

RD-MG15

- [BG] Шлифовалка • [RO] Set mini polizor drept

8000 - 33000 min⁻¹

135 W

100 accessories

230 V



ART.NO. BARCODE
044115 3800972034761

MINI GRINDER SET

RD-MG12

- [BG] Шлифовалка • [RO] Set mini polizor drept



8000 - 32000 min⁻¹

135 W

230 V

40 accessories



ART.NO. BARCODE
044112 3800972032941

MINI GRINDER SET

RD-MG11

- [BG] Шлифовалка • [RO] Set mini polizor drept



8000 - 32000 min⁻¹

230 V

135 W

40 accessories



ART.NO. BARCODE
044111 3800972032934

MINI GRINDER SET

RD-MG07

- [BG] Шлифовалка • [RO] Set mini polizor drept



6000 - 35000 min⁻¹

230 V

160 W



ART.NO. BARCODE
044105 3800123166082

MINI GRINDER SET

RD-MG06J

• [BG] Шлифовалка • [RO] Set mini polizor drept

3.2
Ømm
210
accessories

135
W

1000 - 3200
min⁻¹

230
V



ART.NO. BARCODE
044104 3800123124242

MINI GRINDER SET

RD-MG09

• [BG] Шлифовалка • [RO] Set mini polizor drept

3.2
Ømm
8000 - 35000
min⁻¹

230
V

LCD
display

170
W



ART.NO. BARCODE
044107 3800123170782

FLEXIBLE SHAFT FOR MINI GRINDER

RD

• [BG] Жило за шлифовалка • [RO] Transmisie flexibila pentru minipolizor

5000-
35 000
min⁻¹



ART.NO. BARCODE
138403 3800123170768

ACCESSORIES FOR MINI GRINDER SET

RD

• [BG] Комплект аксесоари за шлифовалка
• [RO] Set accesorii pentru mini polizor drept

96
pcs.



ART.NO. BARCODE
138406 3800972034648

ACCESSORIES FOR MINI GRINDER

RD

• [BG] Комплект аксесоари за шлифовалка
• [RO] Set accesorii pentru mini polizor drept

227
pcs.



ART.NO. BARCODE
138407 3800972034655

ACCESSORIES FOR MINI GRINDER

RD

• [BG] Комплект аксесоари за шлифовалка
• [RO] Set accesorii pentru mini polizor drept

249
pcs.

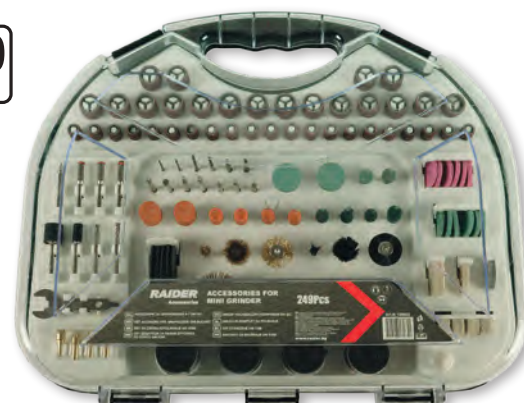

ART.NO. BARCODE
138402 3800123170751

ACCESSORIES FOR MINI GRINDER

RD

- [BG] Комплект аксесоари за шлифовалка
- [RO] Set accesorii pentru mini polizor drept

276
pcs.



ART.NO.	BARCODE
138408	3800972034662

ACCESSORIES FOR MINI GRINDER

RD

- [BG] Комплект аксесоари за шлифовалка
- [RO] Set accesorii pentru mini polizor drept

418
pcs.



ART.NO.	BARCODE
138409	3800972034679

DIAMOND BURRS

RD

- [BG] Борчета диамантени • [RO] Set 20 ace pentru slefuit biax

Ø3
20 pcs.



ART.NO.	BARCODE
157709	3800123121333

DIAMOND BURRS

RD

- [BG] Борчета диамантени • [RO] Set 30 ace pentru slefuit biax

Ø3
30 pcs.



ART.NO.	BARCODE
157708	3800123121340



CIRCULAR SAW BLADE

RD

• [BG] Диск за циркуляр • [RO] Disc circular pentru lemn



ART.NO.	BARCODE	USE	SIZE
163137	3800123166105	WOOD	85x30Tx10 mm
163138	3800123166112	WOOD	85x80Tx10 mm

CUTTING DISC METAL

FOR RD-CS24

• [BG] Диск за метал • [RO] Disc pentru taiat metal 8



ART.NO.	BARCODE	USE	SIZE
160150	3800123166129	METAL	85x1.0x10 mm

DIAMOND CUTTING DISC DRY

FOR RD-CS24

• [BG] Диск диамантен DRY • [RO] Disc diamantat segmentat DRY



ART.NO.	BARCODE
162122	3800123166143

DIAMOND CUTTING DISC WET

FOR RD-CS24

• [BG] Диск диамантен WET • [RO] Disc diamantat continuu WET



ART.NO.	BARCODE
162121	3800123166136

MULTI PURPOSE CIRCULAR SAW

RD-CS40

• [BG] Циркуляр ръчен за камък и плочки • [RO] Fierastrau circular

**ИДВА СКОРО
COMING SOON**

ART.NO.	BARCODE
052113	3800972046016

MULTI PURPOSE CIRCULAR SAW

RD-CS28

• [BG] Циркуляр ръчен за камък и плочки • [RO] Fierastrau circular



ART.NO.	BARCODE
052111	3800972016323

CIRCULAR SAW BLADE TUNGSTEN CARBIDE TIPPED FOR RD-CS25 & 28

• [BG] Диск за циркуляр • [RO] Disc circular pentru metal & lemn



ART.NO.	BARCODE
163139	3800123167560

DIAMOND CUTTING DISC WET FOR RD-CS25 & 28

• [BG] Диск диамантен WET • [RO] Disc diamantat continuu WET



ART.NO.	BARCODE
162123	3800123167577

CIRCULAR SAW RD-CS32

• [BG] Циркуляр ръчен • [RO] Fierastrau circular



ART.NO.	BARCODE
052132	3800972032569

CIRCULAR SAW RD-CS31

• [BG] Циркуляр ръчен • [RO] Fierastrau circular



ART.NO.	BARCODE
052131	3800972028623

CIRCULAR SAW RD-CS21B

• [BG] Циркуляр ръчен • [RO] Fierastrau circular



ART.NO.	BARCODE
052106	3800123159039

CIRCULAR SAW RD-CS22B

• [BG] Циркуляр ръчен • [RO] Fierastrau circular



ART.NO.	BARCODE
052201	3800123159046

CIRCULAR SAW

RDP-CS30

• [BG] Циркулярен ръчен • [RO] Fierastrau circular



RAIDER®
Pro

ART.NO.	BARCODE
052130	3800972024380

GUIDE SYSTEM

RDP

• [BG] Водещ линеал
• [RO] Sistem ghidare 900mm si clema pentru circular Raider Pro



900
mm

RAIDER®
Pro

ART.NO.	BARCODE
052133	3800972035577

STRAIGHT EDGE GUIDE EXTENSION

RDP

• [BG] Удължение за водещия линеал
• [RO] Extensie dreapta pentru sistem ghidare



635
mm

RAIDER®
Pro

ART.NO.	BARCODE
052134	3800972035584

PLANER

RD-EP17

• [BG] Ренде електрическо • [RO] Rindea electrica



ART.NO.	BARCODE
055107	3800972033290

PLANER

RD-EP12

• [BG] Ренде електрическо • [RO] Rindea electrica



ART.NO.	BARCODE
055201	3800123158926

PLANER WITH STAND

RDP-EP15

• [BG] Ренде електрическо със стойка • [RO] Rindea electrica cu stand



ART.NO.	BARCODE
055202	3800972016378

RAIDER®
Pro

PLANER WITH STAND

RDP-EP18

• [BG] Ренде електрическо със стойка • [RO] Rindea electrica cu stand



ART.NO. 055108
BARCODE 3800972033306

RAIDER®
Pro

BLADES FOR PLANERS 2 PCS

RD

• [BG] Ножове за ренде • [RO] Set 2 lame 110 mm pentru rindea



ART.NO. 055109
BARCODE 3800972040465

REVERSIBLE BLADES FOR PLANERS 2 PCS

RD

• [BG] Ножове за ренде • [RO] Set 2 lame 82mm pt rindea electrica



ART.NO. 209937
BARCODE 3800123104800

ROUTER

RD-ER09

• [BG] Оберфреза • [RO] Freza electrica

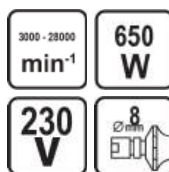

ART.NO. 051109
BARCODE 3800972031586

ROUTER

RD-ER07

• [BG] Оберфреза • [RO] Freza electrica



ART.NO. 051102
BARCODE 3800123124518

ROUTER

RD-ER10

• [BG] Оберфреза • [RO] Freza electrica

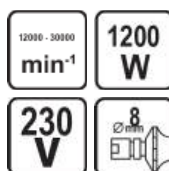

ART.NO. 051110
BARCODE 3800972033320

ROUTER TABLE

RD-RT01

• [BG] Маса работна за обертфреза • [RO] Masa pentru frezare

SIZE
450x335 mm
mm



ART.NO.	BARCODE
059907	3800123123467

HINGE HOLE CUTTER TCT SHAFT Ø8

RD

• [BG] Фрезер за отвор TCT опашка Ø8 mm
• [RO] Freza pentru balamale varf carbura TCT ax 8 mm

ART.NO.	BARCODE	SIZE
157503	3800972050655	Ø15 mm
154601	3800123121258	Ø16 mm
157504	3800972050662	Ø18 mm
154602	3800123121265	Ø20 mm
157505	3800972050679	Ø22 mm
157506	3800972050686	Ø23 mm
154603	3800123121272	Ø25 mm
157507	3800972050693	Ø28 mm
154604	3800123121289	Ø30 mm
157508	3800972050709	Ø32 mm
154605	3800123121296	Ø35 mm
154516	3800972050785	Ø35 mm & DEPTH STOP



ART.NO.	BARCODE	SIZE
157509	3800972050716	Ø38 mm
154606	3800123121302	Ø40 mm
157510	3800972050723	Ø45 mm

HINGE CUTTING BITS TUNGSTEN CARBIDE TIPPED 5PCS. SET

RD

• [BG] Фрезери за отвори с твърдосплавни пластини
• [RO] Freze ptr balamale set 5pcs

5
pcs.



ART.NO.	BARCODE	SIZE	SHAFT
157502	3800123121210	Ø15,20,25,30,35 mm	8 mm

ROUTER BIT

RD

• [BG] Фрезер за обертфреза • [RO] Freza profilata

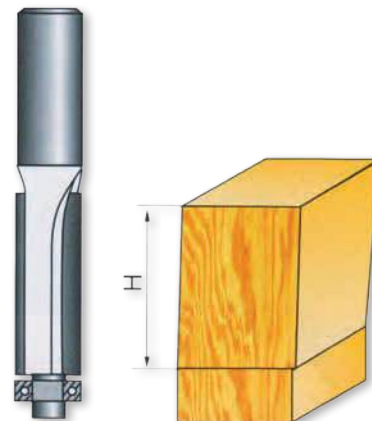

ART.NO.	BARCODE	SIZE	SHAFT
154405	3800123169700	Ø9.5 mm H38 mm	8 mm

ROUTER BIT

RD

• [BG] Фрезер за обертфреза • [RO] Freza profilata



ART.NO.	BARCODE	SIZE	SHAFT
154402	3800123121531	Ø12.7 mm H25 mm	8 mm

ROUTER BIT

RD

• [BG] Фрезер за обертфреза • [RO] Freza profilata



ART.NO.	BARCODE	SIZE	SHAFT
154406	3800123169717	Ø12.7 mm H50.8 mm	8 mm

ROUTER BIT

RD

• [BG] Фрезер за обертфреза • [RO] Freza profilata



ART.NO.	BARCODE	SIZE	SHAFT
154401	3800123121548	Ø15.9 mm H20 mm	8 mm

ROUTER BIT

RD

• [BG] Фрезер за обертфреза • [RO] Freza profilata



ART.NO.	BARCODE
154409	3800123169748

ROUTER BIT

RD

• [BG] Фрезер за обертфреза • [RO] Freza profilata



ART.NO.	BARCODE
154407	3800123169724

ROUTER BIT

RD

• [BG] Фрезер за обертфреза • [RO] Freza profilata



ART.NO.	BARCODE
154404	3800123121524

ROUTER BIT

RD

• [BG] Фрезер за обертфреза • [RO] Freza profilata



ART.NO.	BARCODE
154408	3800123169731

ROUTER BIT

RD

• [BG] Фрезер за обертфреза • [RO] Freza profilata



ART.NO.	BARCODE
154403	3800123121555

ROUTER BITS

RD

• [BG] Фрезери за обертфреза • [RO] Freze profilate Router bits

5
pcs.

Ø8
mm

TYPE B



ART.NO. BARCODE
158301 3800123121500

ROUTER BITS

RD

• [BG] Фрезери за обертфреза • [RO] Freze profilate Router bits

5
pcs.

Ø8
mm

TYPE C



ART.NO. BARCODE
158302 3800123121517

5 бр.

ROUTER BITS

RD

• [BG] Фрезери за обертфреза • [RO] Freze profilate Router bits

12
pcs.

Ø8
mm



ART.NO. BARCODE
158303 3800123121630

ROUTER BITS

RD

• [BG] Фрезери за обертфреза • [RO] Freze profilate Router bits

15
pcs.

Ø8
mm

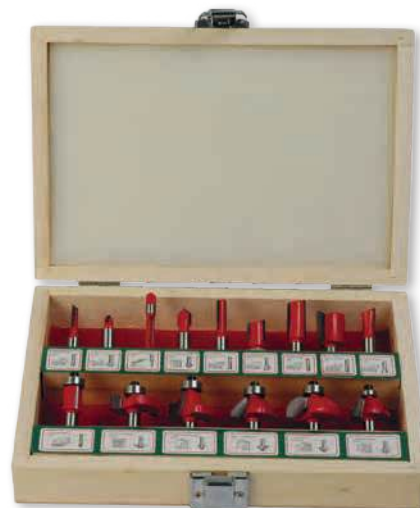

ART.NO. BARCODE
158304 3800123121241

15 бр.

ROUTER BITS

RD

• [BG] Фрезери за обертфреза • [RO] Freze profilate Router bits

35
pcs.

Ø8
mm



ART.NO. BARCODE
158305 3800123121678



BISCUIT JOINTER

RD

• [BG] Фреза за плоски дибли • [RO] Freza pentru imbinat biscuiti de lemn



12000
min⁻¹

900
W

230
V



ART.NO. BARCODE
059906 3800123123443

TUNGSTEN CARBIDE TIPPED GROOVING CUTTER

RD

• [BG] Диск за бисквит машина
• [RO] Disc circular pentru imbinat biscuiti de lemn



ART.NO. BARCODE
163141 3800123167553

ELECTRIC STAPLER

RD-ES15

• [BG] Такеп • [RO] Capsator electric



ART.NO. BARCODE
129998 3800123133725

ELECTRIC STAPLER

RD-ES16

• [BG] Такеп • [RO] Capsator electric



ART.NO. BARCODE
059601 3800123167959

WET & DRY VACUUM CLEANER

RD-WC08

• [BG] Прахосмукачка за сухо и мокро почистване • [RO] Aspirator umed/uscat



ART.NO. BARCODE
090317 3800972015869

WET & DRY VACUUM CLEANER

RD-WC09

• [BG] Прахосмукачка за сухо и мокро почистване • [RO] Aspirator umed/uscat



ART.NO. BARCODE
090318 3800972015876

WET & DRY VACUUM CLEANER

RD-WC10

• [BG] Прахосмукачка за сухо и мокро почистване • [RO] Aspirator umed/uscat



ART.NO. 090321
BARCODE 3800972015913

VACUUM CLEANER BAGS 3 PCS

FOR RD-WC08 WC09 WC10 SDWC20

• [BG] Торби за прахосмукачка 3 бр. • [RO] Sac pentru aspirator 3 pcs



ART.NO. 090306
BARCODE 3800972000759

WET & DRY VACUUM CLEANER

RD-WC14

• [BG] Прахосмукачка за сухо и мокро почистване • [RO] Aspirator umed/uscat

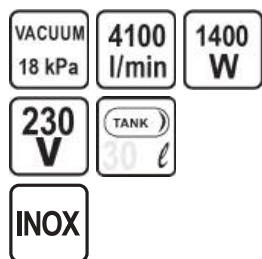

ART.NO. 090339
BARCODE 3800972040984



WET & DRY VACUUM CLEANER

RD-WC07

• [BG] Прахосмукачка за сухо и мокро почистване • [RO] Aspirator umed/uscat



ART.NO. 090316
BARCODE 3800972015852

VACUUM CLEANER BAGS 3 PCS.

FOR RD-WC07

• [BG] Торби за прахосмукачка 3 бр. • [RO] Sac pentru aspirator 3 pcs



ART.NO. 090328
BARCODE 3800972024311

WET & DRY VACUUM CLEANER

RDP-WC04

- [BG] Прахосмукачка за сухо и мокро почистване
- [RO] Aspirator umed/uscat



RAIDER®
Pro

ART.NO. BARCODE
090310 3800972012622

VACUUM CLEANER BAGS

RD-WC04

- [BG] Торби за прахосмукачка 2 бр.
- [RO] Sac pentru aspirator 2 pcs

30 L



ART.NO. BARCODE
090312 3800972014978

HEPA FILTER

RD-WC04

- [BG] Хепа филтър • [RO] Filtru HEPA

Ø137 mm L 137 mm



ART.NO. BARCODE
090311 3800972012639

WET & DRY VACUUM CLEANER

RDP-WC13

- [BG] Прахосмукачка за сухо и мокро почистване
- [RO] Aspirator umed-uscat



RAIDER®
Pro

ART.NO. BARCODE
090332 3800972032088

HEPA FILTER

RDP-WC13

- [BG] Хепа филтър
- [RO] Filtru HEPA

Ø180 x Ø146 mm L 145 mm



RAIDER®
Pro

ART.NO. BARCODE
090337 3800972036499

VACUUM CLEANER BAGS

3A RDP-WC13

- [BG] Торби за прахосмукачка 2 бр.
- [RO] Sac pentru aspirator 2 pcs



RAIDER®
Pro

ART.NO. BARCODE
090340 3800972041240

SPRAY WET & DRY VACUUM CLEANER

RDP-WC33

- [BG] Прахосмукачка Spray Wet&Dry
- [RO] Aspirator umed/uscat cu pulverizare



RAIDER®
Pro

ART.NO. BARCODE
090333 3800972033375

HEPA FILTER FOR VACUUM CLEANER

RDP-WC33

- [BG] Хепа филтър за прахосмукачка
- [RO] Filtru HEPA pentru aspirator



RAIDER®
Pro

ART.NO. BARCODE
090334 3800972033382

VACUUM CLEANER BAGS 4 PCS

3A RDP-WC33

- [BG] Торби за прахосмукачка 4 бр.
- [RO] Set 4 saci aspirator pentru

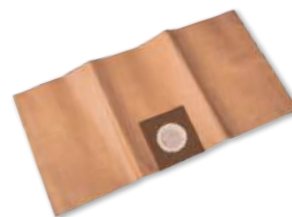

RAIDER®
Pro

ART.NO. BARCODE
090335 3800972033399

ASH VACUUM CLEANER

RD-WC06

• [BG] Прахосмукачка за пепел • [RO] Aspirator pentru cenusa



ART.NO. 090314
BARCODE 3800972015838

HEPA FILTER

RD-WC02 & 05

• [BG] Хепа филтър • [RO] Filtru HEPA



ART.NO. 090305
BARCODE 3800123173684

ASH VACUUM CLEANER

RD-WC02N

• [BG] Прахосмукачка за пепел • [RO] Aspirator pentru cenusa



ART.NO. 090304
BARCODE 3800123173448

HEPA FILTER

RD-WC02N

• [BG] Хепа филтър • [RO] Filtru HEPA



ART.NO. 090327
BARCODE 3800972023666

ASH VACUUM CLEANER

RD-WC03

• [BG] Прахосмукачка за пепел • [RO] Aspirator pentru cenusa



ART.NO. 090308
BARCODE 3800972008823

HEPA FILTER

RD-WC03

• [BG] Хепа филтър • [RO] Filtru HEPA



ART.NO. 090309
BARCODE 3800972008830

TABLE SAW

RD-TS20

• [BG] Циркуляр с плот • [RO] Fierastrau circular cu masa



MITRE SAW

RD-MS02

• [BG] Циркуляр настолен • [RO] Fierastrau circular semi-stationar



MITRE SAW

RD-MS21

• [BG] Циркуляр настолен • [RO] Fierastrau circular semi-stationar



MITRE SAW

RD-MS08

• [BG] Циркуляр настолен • [RO] Fierastrau circular semi-stationar



MITRE SAW

RD-MS06

• [BG] Циркуляр настолен • [RO] Fierastrau circular semi-stationar

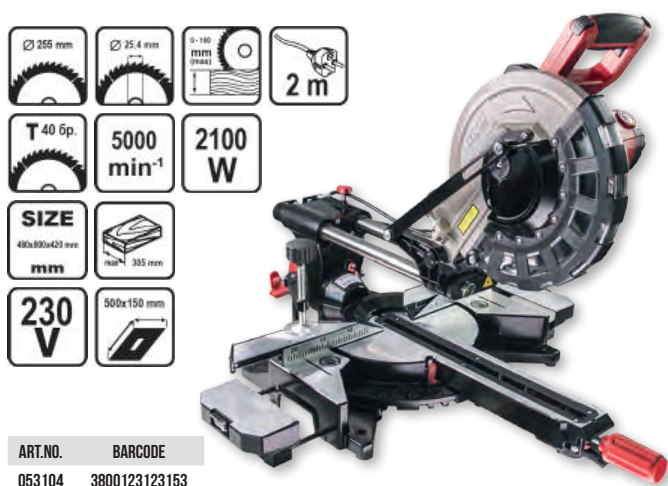

MITRE SAW

RDP-MS12

• [BG] Циркуляр настолен • [RO] Fierastrau circular semi-stationar





COMBINATION TABLE & MITRE SAW

RD-MS10

• [BG] Циркулярен стол • [RO] Fierastrau circular semi-stationar



ART.NO. BARCODE
054104 3800123141911

BAND SAW

RD-BSW18

• [BG] Банциг
• [RO] Fierastrau cu banda



ART.NO. BARCODE
059902 3800123162176



BAND SAW BLADE

3A RD-BSW18

• [BG] Лента за банциг • [RO] Lama pentru fierastrau cu banda



ART.NO. BARCODE
155701 3800123162183

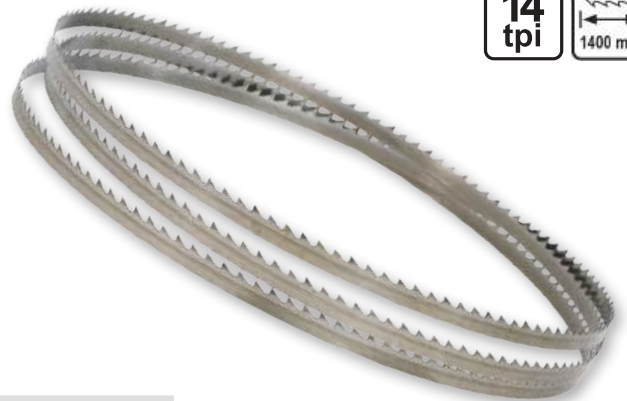

SCROLL SAW

RD-SS16

• [BG] Контурен трион • [RO] Fierastrau pendular de banc



ART.NO. BARCODE
059903 3800123124945



SCROLL SAW BLADE 6 PCS. SET

RD

• [BG] Нож за контурен трион 6 части
• [RO] Lama Fierastrau pentru Fierastrau de ban 6 buc

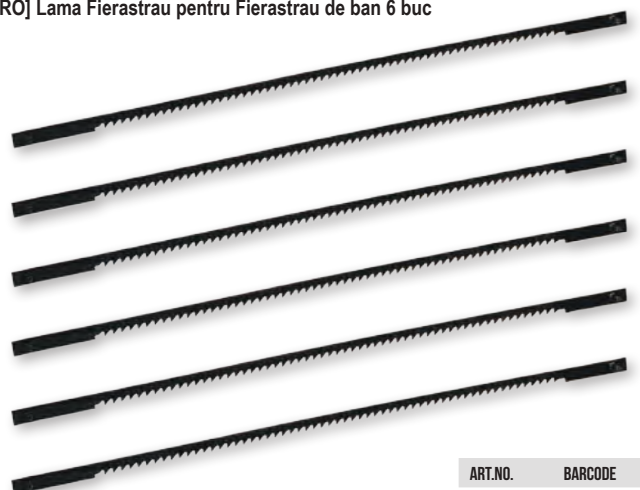

ART.NO. BARCODE
209912 3800123107627

UNIVERSAL FOLDING WORKING CENTRE

RD

• [BG] Стойка за настолни машини • [RO] Banc de lucru reglabil



0.86m-
1.6m

ART.NO. BARCODE
059912 3800972038356

UNIVERSAL FOLDING WORKING CENTRE

RD

• [BG] Стойка за настолни машини • [RO] Banc de lucru reglabil

2.8m x
82cm



ART.NO. BARCODE
059904 3800972032286

TABLE SAW WITH EXTENSION WINGS AND STAND

RD-TS12B

• [BG] Циркулярен стационарен • [RO] Fierastrau circular cu masa



4800
min⁻¹

2200
W

0-30°

230
V



ART.NO. BARCODE
059403 3800123160738

TABLE SAW WITH EXTENSION WINGS AND STAND

RD-TS10

• [BG] Циркулярен стационарен • [RO] Fierastrau circular cu masa



2950
min⁻¹

2000
W

230
V

SIZE
550x620x53 mm



ART.NO. BARCODE
053105 3800123123207

ELECTRIC LOG CUTTING SAW

RD-LS01

• [BG] Циркулярен за рязане на дърва • [RO] Circular cu suport pt. tait lemne foc



2200
W

230
V



ART.NO. BARCODE
129940 3800123168475

WOODWORKING LATHE

RD-WL04

• [BG] Струг за дърво • [RO] Strung pentru lemn

800-
3000
min⁻¹

0.6
kW

230
V

L
600
mm



ART.NO. BARCODE
059913 3800972026711

BENCH THICKNESSER

RDP-BPT01

• [BG] Щрайхмус • [RO] Masina de degrosat

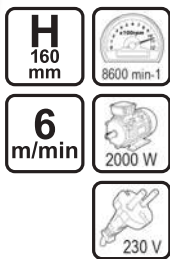
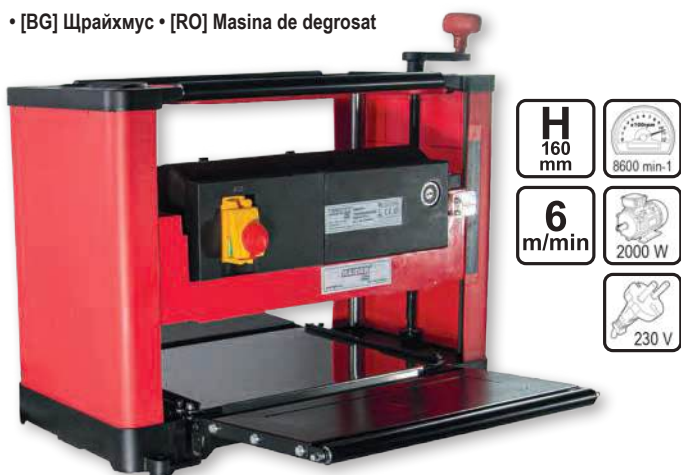

ART.NO. BARCODE
059404 3800972026513

RAIDER®
Pro

BLADES FOR THICKNESSER 2 PCS.

RDP-BPT01

• [BG] Ножове за щрайхмус 2бр. • [RO] Set 2 cutite pentru masina de degrosat



ART.NO. BARCODE
155505 3800972026520

RAIDER®
Pro

PLANNER THICKNESSER

RDP-APT02

• [BG] Абрихт & Щрайхмус • [RO] Masina de degrosat



ART.NO. BARCODE
059405 3800972032071

RAIDER®
Pro

BLADES SET FOR PLANNER THICKNESSER

RDP-APT02

• [BG] Ножове за абрихт-щрайхмус
• [RO] Set 2 lame pentru masina de degrosat



ART.NO. BARCODE
155542 3800972034303

RAIDER®
Pro

COMBINED WOODWORKING MACHINE

RDP-CWM01

• [BG] Машина дървообработваща мултифункционална
• [RO] Masina combinata pt tamplarie



ART.NO. BARCODE
059402 3800123158995

RAIDER®
Pro

BLADES FOR PLANNER 2 PCS SET

RDP

• [BG] Ножове за абрихт 2 бр. • [RO] Set 2 cutite – masina de degrosat



ART.NO.	BARCODE	SIZE
155501	3800123162060	250 mm
155504	3800123171215	305 mm

RAIDER®
Pro

DUST COLLECTOR

RD-DC02

• [BG] Прахоуловител • [RO] Aspirator industrial



ART.NO.	BARCODE
059909	3800972033337

HEPA FILTER FOR DUST COLLECTOR

3A RD-DC02

• [BG] Хепа филтър за прахоуловител
• [RO] Filtru HEPA pentru colector de praf



ART.NO.	BARCODE
059910	3800972033344

DUST BAGS 2 PCS. FOR DUST COLLECTOR

3A RD-DC02

• [BG] Торби за прахоуловител 2 бр.
• [RO] Set 2 saci pentru colector de praf



ART.NO.	BARCODE
059911	3800972033351

DUST COLLECTOR

RD-DC01B

• [BG] Прахоуловител
• [RO] Aspirator industrial



ART.NO.	BARCODE
059908	3800123123474

CUT OFF MACHINE

RD-CM09

• [BG] Циркуляр за метал • [RO] Fierastrau circular pentru debitat metal



ART.NO.	BARCODE
060109	3800972024045

CUT OFF MACHINE

RD-CM11

• [BG] Циркуляр за метал • [RO] Fierastrau circular pentru debitat metal



ART.NO.	BARCODE
060111	3800972032095

CUT OFF MACHINE

RD-CM08

• [BG] Циркуляр за метал • [RO] Fierastrau circular pentru debitat metal



ART.NO.	BARCODE
060108	3800972016330

METAL-CUTTING BAND SAW SWIVELLING

RDP-BSM01

• [BG] Банциг за метал • [RO] Fierastrau cu banda de taiat metal



ART.NO. 060110
BARCODE 3800972027930

RAIDER®
Pro

SAW BAND FOR STEEL

3A RDP-BSM01

• [BG] Лента за банциг за метал • [RO] Banda de ferastrau pentru



ART.NO. 155702
BARCODE 3800972027947

RAIDER®
Pro

BENCH GRINDER

RD-BG01

• [BG] Шмиргел • [RO] Polizor de banc



ART.NO. 061102
BARCODE 3800123124099

RAIDER®
Pro

BENCH GRINDER

RDP-BG02

• [BG] Шмиргел • [RO] Polizor de banc



ART.NO. 061103
BARCODE 3800123124204

RAIDER®
Pro

WET AND DRY BENCH GRINDER

RDP-BG03

• [BG] Шмиргел редукторен • [RO] Polizor de banc



ART.NO. 061104
BARCODE 3800123124273

RAIDER®
Pro

BENCH GRINDER

RDP-BG04

• [BG] Шмиргел • [RO] Polizor de banc



ART.NO. 061101
BARCODE 3800123123825

RAIDER®
Pro

BENCH GRINDER WITH SANDING BELT

RDP-BG05

• [BG] Шмиргел с лентов шлайф • [RO] Polizor de banc-slefuitor cu banda



RAIDER®
Pro

ART.NO.	BARCODE
061105	3800123123108

SANDING BELTS FOR BENCH GRINDER WITH SANDING BELT 5 PCS.

RDP

• [BG] Шкурка за лентов шмиргел 5 бр. • [RO] Set 5 benzi smirghel neperforat



ART.NO.	BARCODE	SIZE	GRIT
183116	3800123135309	50x686 mm	P40
183117	3800123135316	50x686 mm	P60
183118	3800123135323	50x686 mm	P80
183119	3800123135330	50x686 mm	P100
183120	3800123136252	50x686 mm	P120

RAIDER®
Pro

BENCH GRINDER WITH MINI GRINDER FLEXIBLE SHAFT

RD-BG06

• [BG] Шмиргел с мини шлифовалка • [RO] Mini polizor de banc



ART.NO.	BARCODE
129928	3800123123450

GRINDING WHEEL

RDP

• [BG] Диск за шмиргел • [RO] Piatra ptr polizor



RAIDER®
Pro

ART.NO.	BARCODE	SIZE	GRIT
165119	3800123127519	Ø150x16xØ20(13) mm	P36
165120	3800123127526	Ø150x16xØ20(13) mm	P80
165123	3800123127557	Ø200x20xØ20(16) mm	P60
165124	3800123127564	Ø200x40xØ20 mm	P60

GRINDING WHEEL

RDP

• [BG] Диск за шмиргел • [RO] Piatra ptr polizor



RAIDER®
Pro

ART.NO.	BARCODE	SIZE	GRIT
165121	3800123127533	Ø200x20xØ20(16) mm	P60

GRINDING WHEEL

RDP

• [BG] Диск за шмиргел • [RO] Piatra ptr polizor



RAIDER®
Pro

ART.NO.	BARCODE	SIZE	GRIT
165122	3800123127540	Ø200x20xØ20(16) mm	P60

GRINDING WHEEL

RDP

• [BG] Диск за шмиргел • [RO] Piatra ptr polizor



RAIDER®
Pro

ART.NO.	BARCODE	SIZE	GRIT
165126	3800123171840	Ø75x20xØ10 mm	G120

POLISHING WHEEL

RDP

• [BG] Диск за шмиргел • [RO] Piatra ptr polizor



RAIDER®
Pro

ART.NO.	BARCODE	SIZE	GRIT
165127	3800123171857	Ø75x20xØ10 mm	PVE400



ELECTRIC SPRAY GUN

RD-ESG01

• [BG] Пистолет за боя • [RO] Pistol de vopsit

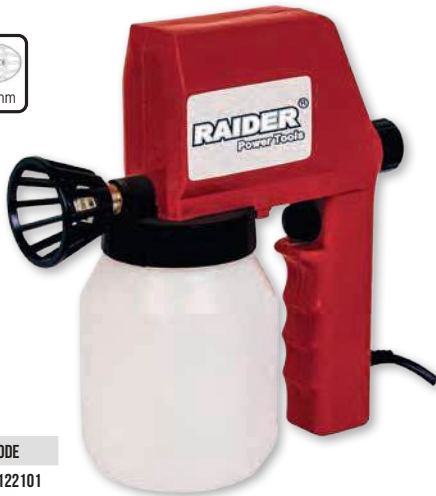

ART.NO. BARCODE
129921 3800123122101

ELECTRIC SPRAY GUN

RDP-ESG11P

• [BG] Пистолет за боя • [RO] Pistol de vopsit



RAIDER®
Pro

ART.NO. BARCODE
129952 3800123127861

ELECTRIC SPRAY GUN

RD-SGC12

• [BG] Пистолет за боя • [RO] Pistol de vopsit



ART.NO. BARCODE
074112 3800972046214

ELECTRIC SPRAY GUN

RD-SGC13

• [BG] Пистолет за боя • [RO] Pistol de vopsit



ART.NO. BARCODE
074113 3800972046221

NOZZLES

3A RD-SGC12 & 13

• [BG] Дюзи к-кт • [RO] Setr filtre si duze



ART.NO. BARCODE
074114 3800972046238

ELECTRIC SPRAY GUN

RD-SGC10

• [BG] Пистолет за боя • [RO] Pistol de vopsit



ART.NO. BARCODE
074110 3800972031722

ELECTRIC SPRAY GUN

RD-SGC11

• [BG] Пистолет за боя • [RO] Pistol de vopsit



ART.NO. BARCODE
074111 3800972033412

ELECTRIC SPRAY GUN

RD-SGC02 RD

• [BG] Пистолет за боя • [RO] Pistol de vopsit



ART.NO. BARCODE
074101 3800123158469

HIGH PRESSURE AIRLESS SPRAYER

RDP-HPAS01

• [BG] Машина за безвъздушно боядисване • [RO] Pistol de vopsit fara aer



RAIDER®
Pro

ART.NO. BARCODE
074204 3800972032446

FILTER HIGH PRESSURE AIRLESS SPRAYER

RDP-HPAS01

• [BG] Филтър за машина за безвъздушно боядисване
• [RO] Filtru pentru pistol de vopsit fara aer



ART.NO. BARCODE
074205 3800972032774

RAIDER®
Pro

NOZZLE FOR HIGH PRESSURE AIRLESS SPRAYER

RDP-HPAS01

• [BG] Дюза за машина за безвъздушно боядисване
• [RO] Duza pentru pistol de vopsit fara aer



RAIDER®
Pro

ART.NO. BARCODE
074206 3800972032781

HOSE FOR HIGH PRESSURE AIRLESS SPRAYER

RDP-HPAS01

• [BG] Маркуч за машина за безвъздушно боядисване
• [RO] Furtun pentru pistol de vopsit fara aer



ART.NO. BARCODE
074207 3800972032798

RAIDER®
Pro

ELECTRIC WEED BURNER

RD-HG20

• [BG] Пистолет за горещ въздух • [RO] Arzator electric de buruieni

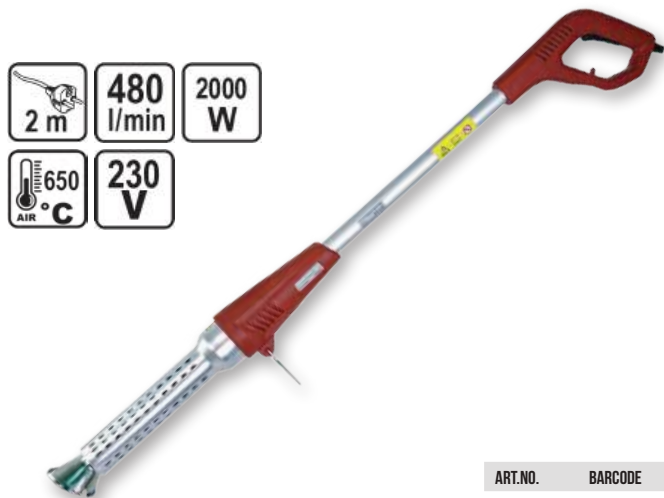

ART.NO. 074309
BARCODE 3800972001978

HEAT GUN

RD-HG25

• [BG] Пистолет за горещ въздух • [RO] Pistol aer cald



ART.NO. 074313
BARCODE 3800972032958

HEAT GUN

RD-HG26

• [BG] Пистолет за горещ въздух • [RO] Pistol aer cald



ART.NO. 074314
BARCODE 3800972032965

HEAT GUN

RD-HG27

• [BG] Пистолет за горещ въздух • [RO] Pistol aer cald



ART.NO. 074315
BARCODE 3800972032972



HEAT GUN

RD-HG28

• [BG] Пистолет за горещ въздух • [RO] Pistol aer cald



ART.NO. 074316
BARCODE 3800972032989

HEAT GUN

RD-HG29

• [BG] Пистолет за горещ въздух • [RO] Pistol aer cald

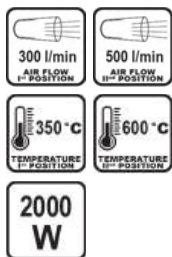

ART.NO. BARCODE
074317 3800972043367

HEAT GUN

RD-HG30

• [BG] Пистолет за горещ въздух • [RO] Pistol aer cald

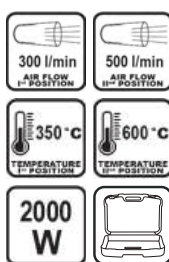

ART.NO. BARCODE
074318 3800972043374

HEAT GUN

RD-HG32

• [BG] Пистолет за горещ въздух • [RO] Pistol aer cald

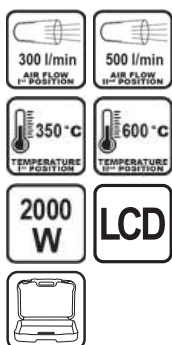

ART.NO. BARCODE
074320 3800972043398

HEAT GUN

RD-HG31

• [BG] Пистолет за горещ въздух • [RO] Pistol aer cald

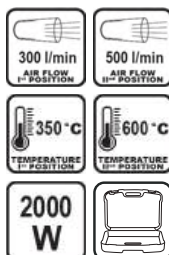

ART.NO. BARCODE
074319 3800972043381



HANDLE MIXER

RD-HM05

• [BG] Миксер • [RO] Mixer electric



ART.NO.	BARCODE
078503	3800123167584

HANDLE MIXER

RD-HM07

• [BG] Миксер • [RO] Mixer electric



ART.NO.	BARCODE
078508	3800972009219

HANDLE MIXER

RD-HM11

• [BG] Миксер • [RO] Mixer electric

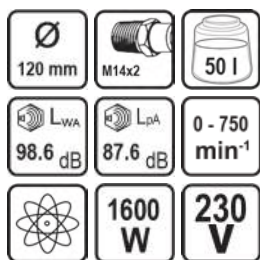

ART.NO.	BARCODE
078511	3800972019720

HANDLE MIXER

RDP-HM08

• [BG] Миксер • [RO] Mixer electric

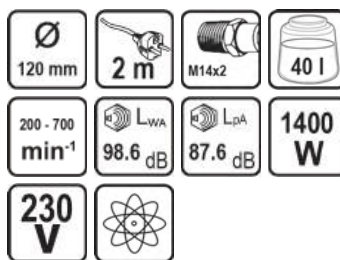

RAIDER®
Pro

ART.NO.	BARCODE
078509	3800972009158



HANDLE MIXER

RDP-HM10

• [BG] Миксер • [RO] Mixer electric

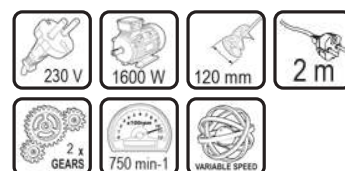

RAIDER®
Pro

ART.NO.	BARCODE
078602	3800972018020

HANDLE MIXER

RDP-HM12

• [BG] Миксер • [RO] Mixer electric



RAIDER®
Pro

ART.NO.	BARCODE
078603	3800972032439

HANDLE MIXER

RDP-HM13

• [BG] Миксер • [RO] Mixer electric



RAIDER®
Pro

ART.NO.	BARCODE
078606	3800972039933

CONCRETE VIBRATOR

RD-CV01

• [BG] Вибратор за бетон • [RO] Vibrator electric pentru beton

0 - 4300
min⁻¹

1300
W

70
dB

230
V



ART.NO.	BARCODE
078604	3800972032668

CONCRATE VIBRATING ROD

3A RD-CV01

• [BG] Гъвкав вал за вибратор за бетон • [RO] Lance vibratoare

1.5 m

Ø35
mm



ART.NO.	BARCODE
078605	3800972032675



TILE CUTTING MACHINE

RD-TC02

• [BG] Машина за плочки • [RO] Masina de taiat placi si piatra



ART.NO.	BARCODE
321501	3800123116308

TILE CUTTING MACHINE

RD-TC03

• [BG] Машина за плочки • [RO] Masina de taiat placi



ART.NO.	BARCODE
321511	3800123116483

TILE CUTTING MACHINE PROFESIONAL

RD-TC10

• [BG] Машина за плочки проф. • [RO] Masina de taiat placi



3in1



ART.NO.	BARCODE
321502	3800123116322

TILE CUTTING MACHINE PROFESIONAL

RD-TC12

• [BG] Машина за плочки проф. • [RO] Masina de taiat placi



ART.NO.	BARCODE
321507	3800123116315

TILE CUTTING MACHINE PROFESIONAL

RD-TC13

• [BG] Машина за плочки проф. • [RO] Masina de taiat placi



ART.NO.	BARCODE
321503	3800123116339

TILE CUTTING MACHINE PROFESIONAL

RD-TC14

• [BG] Машина за плочки проф. • [RO] Masina de taiat placi



ART.NO.	BARCODE
321514	3800123150425

TILE CUTTING MACHINE PROFESIONAL

RD-TC16

• [BG] Машина за плочки проф. • [RO] Masina de taiat placi



ART.NO.	BARCODE
321509	3800123116452

TILE CUTTING MACHINE PROFESIONAL

RD-TC31

• [BG] Машина за плочки проф. • [RO] Masina de taiat placi



ART.NO.	BARCODE
321522	3800972008953

TILE CUTTING MACHINE PROFESIONAL

RD-TC18

• [BG] Машина за плочки проф. • [RO] Masina de taiat placi



ART.NO.	BARCODE
321515	3800123150418

TILE CUTTING MACHINE

RDP-TC32

• [BG] Машина за плочки • [RO] Masina de taiat placi



ART.NO.	BARCODE
321523	3800972024359

RAIDER®
Pro

WHEEL FOR HAND TILE CUTTING MACHINE

3A RD-TC01,02,03

• [BG] Резец за машина за плочки • [RO] Cap taiere placi



ART.NO.	BARCODE
321518	3800123150456

WHEEL FOR HAND TILE CUTTING MACHINE

3A RD-TC16

• [BG] Резец за машина за плочки • [RO] Cap taiere placi



ART.NO.	BARCODE
321521	3800123104749

WHEEL FOR HAND TILE CUTTING MACHINE FOR RD-TC10,12,13

• [BG] Резец за машина за плочки • [RO] Cap taiere placi

Ø16 x
4 x 3.0
mm



ART.NO.	BARCODE
321504	3800123116353

WHEEL FOR HAND TILE CUTTING MACHINE FOR RD-TC11,14,18,31,32

• [BG] Резец за машина за плочки • [RO] Cap taiere placi

Ø16 x
4 x 3.0
mm



ART.NO.	BARCODE
321520	3800123153938

WHEEL FOR HAND TILE CUTTING MACHINE FOR RD-TC14,18,31,32

• [BG] Резец за машина за плочки • [RO] Cap taiere placi

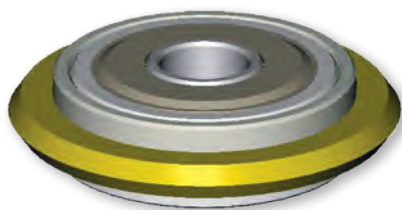

ART.NO.	BARCODE
321524	3800972044401

TILE CUTTING MACHINE RD-ETC25

• [BG] Машина за плочки • [RO] Masina de taiat placi



ART.NO.	BARCODE
129991	3800123131486

TILE CUTTING MACHINE RD-ETC23

• [BG] Машина за плочки • [RO] Masina de taiat placi



ART.NO.	BARCODE
129937	3800123123061

TILE CUTTING MACHINE RDP-ETC30

• [BG] Машина за плочки • [RO] Masina de taiat placi



ART.NO.	BARCODE
078005	3800123172199

TILE CUTTING MACHINE

RDP-ETC26

• [BG] Машина за плочки • [RO] Masina de taiat placi

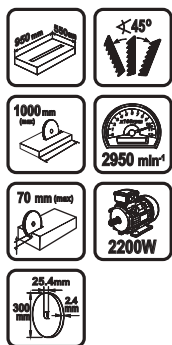

ART.NO. BARCODE
078001 3800123159053

RAIDER®
Pro

TILE CUTTING MACHINE

RDP-ETC31

• [BG] Машина за плочки • [RO] Masina de taiat placi



ART.NO. BARCODE
078006 3800972025219

RAIDER®
Pro

TILE MASONRY SLAB CUTTING MACHINE

RDP-TMS35

• [BG] Машина рязане на строителни материали
• [RO] Masina de taiat placi zidarie



ART.NO. BARCODE
078007 3800972037830

RAIDER®
Pro

SUCTION CUP WITH VACUUM PUMP

RD

• [BG] Вакуум за плочки • [RO] Ventuza manuala cu pompa vid



ART.NO. BARCODE
100403 3800972045552

SUCTION CUP WITH VACUUM PUMP

RD

• [BG] Вакуум за плочки • [RO] Ventuza cu pompa de vid ?i manometru



ART.NO. BARCODE
100401 3800972030992

SUCTION CUP WITH VACUUM PUMP

RD

• [BG] Вакуум за плочки • [RO] Ventuza cu pompa de vid ?i manometru



ART.NO. BARCODE
100404 3800972045569

CORDLESS VACUUM SUCTION CUP

RD-CSC01

• [BG] Вакуум за плочки • [RO] Ventuza cu acumulator



ART.NO.	BARCODE
100402	3800972035430

CORDLESS VACUUM SUCTION CUP

RD-CSC02

• [BG] Вакуум за плочки • [RO] Ventuza cu acumulator



2
Ah

3,7V

260
kg



ART.NO.	BARCODE
100405	3800972045576

HEATING TORCH WITH TRIGGER

RD-GHT01

• [BG] Горелка със спусък • [RO] Brenner

∅ 40 mm L1: 300 mm

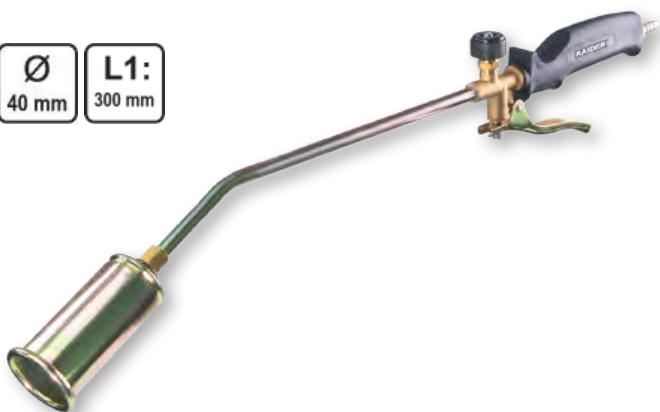

ART.NO.	BARCODE
491512	3800123118722

HEATING TORCH WITH TRIGGER

RD-GHT02

• [BG] Горелка със спусък • [RO] Brenner

∅ 50 mm L1: 40 mm

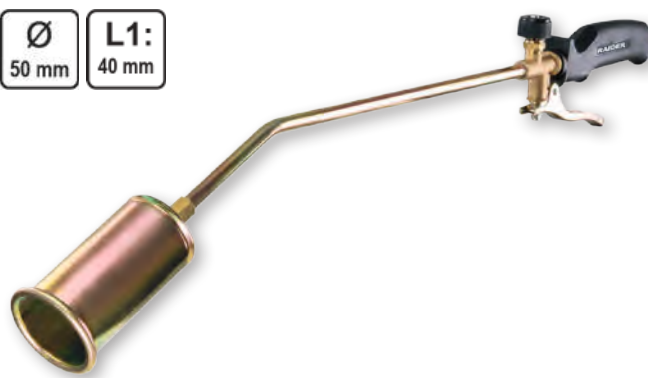

ART.NO.	BARCODE
491513	3800123118739

HEATING TORCH WITH TRIGGER

RD-GHT03

• [BG] Горелка със спусък • [RO] Brenner

∅ 60 mm L1: 400 mm

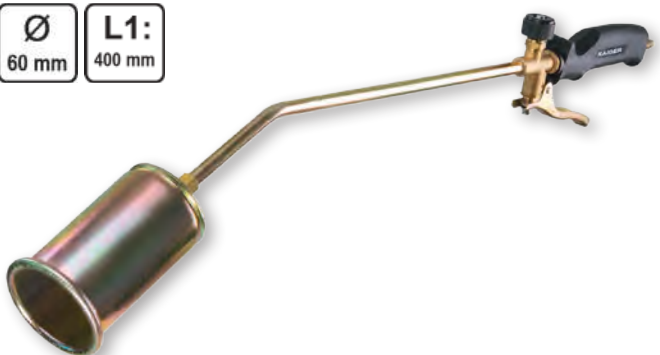

ART.NO.	BARCODE
491514	3800123118746

METAL BLOW TORCH FOR CARTRIDGE

RD-BT02

• [BG] Горелка метална за патрон • [RO] Metal Blow torch for cartridge

190 g ∅ 20 mm



ART.NO.	BARCODE
450101	3800123164606

PPR PIPE WELDING SET

RD-PW01

• [BG] Поялник за PP тръби • [RO] Dispozitiv ptr. lipit tevi PPR se

800 W 230 V Ø mm 20 - 32



ART.NO. 123103
BARCODE 3800123123023

PPR PIPE WELDING SET

RD-PW02

• [BG] Поялник за PP тръби • [RO] Dispozitiv ptr. lipit tevi PPR se

1000 W 230 V Ø mm 20 - 63



ART.NO. 123104
BARCODE 3800123123054

PPR PIPE WELDING SET

RD-PW08

• [BG] Поялник за PP тръби • [RO] Dispozitiv ptr. lipit tevi PPR se



ART.NO. 123116
BARCODE 3800972041288

PPR PIPE WELDING SET

RD-PW05

• [BG] Поялник за PP тръби • [RO] Dispozitiv ptr. lipit tevi PPR se



ART.NO. 123113
BARCODE 3800972041257

PPR PIPE WELDING SET

RD-PW06

• [BG] Поялник за PP тръби • [RO] Dispozitiv ptr. lipit tevi PPR se



ART.NO. 123114
BARCODE 3800972041264

PPR PIPE WELDING SET

RD-CPW07

• [BG] Поялник за PP тръби • [RO] Dispozitiv ptr. lipit tevi PPR se



ART.NO. 123115
BARCODE 3800972041271

SOCKET FOR PPR PIPE WELDING

RD

• [BG] Глава за кръгъл поялник за PP тръби • [RO] Vas de sudura

ART.NO.	BARCODE	SIZE
123117	3800972041301	Ø20 mm
123118	3800972041318	Ø25 mm
123119	3800972041325	Ø32 mm



SOCKET FOR PPR PIPE WELDING

RD

• [BG] Глава за поялник за PP тръби • [RO] Vasuri sudura teava PPR



ART.NO.	BARCODE	SIZE
123108	3800123151156	Ø20 mm
123109	3800123151163	Ø25 mm
123110	3800123151170	Ø32 mm
123111	3800123151187	Ø40 mm

COPPER TUBE EXPANDER 6PCS SET

RD

• [BG] К-кт разширители за медни тръби 6 бр.
• [RO] Set 6 piese dispozitiv expandare teava cupru



ART.NO.	BARCODE
162133	3800972045163

SOLDERING IRON

RD-SI01J

• [BG] Поялник 40W • [RO] Letcon



ART.NO.	BARCODE
123107	3800123143854



SOLDERING IRON

RD

• [BG] Поялник 40W
• [RO] Letcon



ART.NO.	BARCODE
076406	3800123166952



SOLDERING IRON

RD-SI02J

• [BG] Поялник 60W • [RO] Letcon



ART.NO.	BARCODE
076401	3800123159145



SOLDERING IRON

RD-SI03J

• [BG] Поялник 80W • [RO] Letcon



ART.NO.	BARCODE
076402	3800123159152



SOLDERING IRON

RD-SI04J

• [BG] Поялник 60W • [RO] Letcon



ART.NO.	BARCODE
076403	3800123159169



SOLDERING IRON

RD-SI05J

• [BG] Поялник 60W • [RO] Letcon



ART.NO.	BARCODE
076404	3800123159176



SOLDERING IRON

RD-SI06

• [BG] Поялник 100W • [RO] Letcon

100 W 230 V



ART.NO.	BARCODE
076409	3800972018907

SOLDERING IRON STATION

RD-SIS01

• [BG] Станция за запояване • [RO] Statie de lipit

40 W 230 V



ART.NO.	BARCODE
076408	3800123166976

SOLDERING GUN

RD-S0G03

• [BG] Поялник индукционен • [RO] Pistol pentru lipit 1

100 W 230 V



ART.NO.	BARCODE
076407	3800123166969

SOLDERING GUN

RD-S0G02

• [BG] Поялник индукционен • [RO] Pistol pentru lipit 1

175 W 230 V



ART.NO.	BARCODE
123105	3800123123818

TIN ABSORPTION PUMP

RD

• [BG] Помпа за калай • [RO] Pompa absorbtie fluidor



ART.NO.	BARCODE
076405	3800123159183

SOLDER WIRE

RD

• [BG] Тинол • [RO] Fludor



ART.NO.	BARCODE	SIZE
209924	3800123153518	Ø1 mm 200 g 60% Sn 40% Pb
209925	3800123153525	Ø1.6 mm 200 g 60% Sn 40% Pb

SOLDER WIRE

RD

• [BG] Тинол • [RO] Fludor



ART.NO.	BARCODE	SIZE
156601	3800972024212	Ø1 mm 200 g 60% Sn 40% Pb
156602	3800972024229	Ø1.6 mm 200 g 60% Sn 40% Pb

SOLDERING IRON SHARP TIP

RD

• [BG] Паялник остър връх • [RO] Letcon

ART.NO.	BARCODE	DESCRIPTION
076410	3800972047747	SOLDERING IRON 40W SHARP TIP RD-SI10
076411	3800972047754	SOLDERING IRON 60W SHARP TIP RD-SI11
076413	3800972047761	SOLDERING IRON 60W FLAT STRAIGHT TIP RD-SI12
076414	3800972047778	SOLDERING IRON 60W FLAT BENT TIP RD-SI13
076412	3800972047785	SOLDERING IRON 80W SHARP TIP RD-SI14
076415	3800972047792	SOLDERING IRON 100W FLAT BENT TIP RD-SI15
076416	3800972047808	SOLDERING IRON STATION 2IN1 750W 100-480°C LED RDP-SIS16
076417	3800972047815	SOLDERING IRON STATION 100W 200-480°C LED RDP-SIS17
076418	3800972047822	SOLDERING IRON STATION 100W 200-480°C RDP-SIS18



HOT STAPLER PLASTIC WELDING GUN

RD-HSPW01

• [BG] Поялник за пластмаса • [RO] Aparat de lipit plastic cu caspe

60
W
230
V



ART.NO. BARCODE
076206 3800972032866

HOT STAPLER PLASTIC WELDING GUN

RD-HSPW02

• [BG] Поялник за пластмаса • [RO] Aparat de lipit plastic cu caspe

100
W
230
V



ART.NO. BARCODE
076207 3800972032873

HOT STAPLER PLASTIC WELDING GUN

RD-HSPW03

• [BG] Поялник за пластмаса • [RO] Aparat de lipit plastic cu caspe

120
W
230
V



ART.NO. BARCODE
076208 3800972032880

STAPLES FOR HOT STAPLER PLASTIC WELDING GUN

RD

• [BG] Скоби за поялник за пластмаса
• [RO] Caspe pentru pistol sudura plastic

ART.NO.	BARCODE	SIZE
076214	3800972039292	"V" 0,8 mm 200 pcs

ART.NO.	BARCODE	SIZE
076213	3800972039285	"M" 0,6 mm 200 pcs

ART.NO.	BARCODE	SIZE
076215	3800972039308	"W" 0,6 mm 200 pcs

ART.NO.	BARCODE	SIZE
076216	3800972039315	"W" 0,8 mm 200 pcs

STAPLES FOR HOT STAPLER PLASTIC WELDING GUN 1200 PCS SET

RD

• [BG] Скоби за поялник за пластмаса
• [RO] Caspe pentru pistol sudura plastic



ART.NO.	BARCODE	SIZE
076218	3800972039339	MVWS "0,6-0,8 mm 1200 pcs SET

ART.NO.	BARCODE	SIZE
076217	3800972039322	"S" 0,6 mm 200 pcs
076209	3800972032897	"S" 0,8 mm 200 pcs

HOT KNIFE FOAM CUTTER

RD-HKFC01

• [BG] Термо нож за изолации • [RO] Aparat pentru taiat spuma



150
W

ART.NO. BARCODE
076210 3800972032903

FOAM HOT CUTTER

RD-FHC02

• [BG] Уред за рязане на изолации • [RO] Aparat pentru taiat spuma



230V~
50Hz

9.6
W

ART.NO. BARCODE
076212 3800972032927

FOAM HOT WIRE CUTTER

RDP-FHWC03

• [BG] Машина за рязане на изолации • [RO] Cutter electric spuma



ART.NO. BARCODE
076219 3800972043435

RAIDER
Pro

HOT WIRE CUTTER

RDP-FHWC03

• [BG] Нагревател за машина за изолации • [RO] Sarma pentru cutter spuma

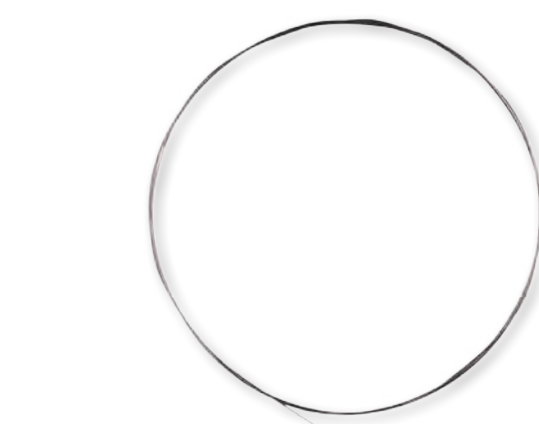

ART.NO. BARCODE
076220 3800972043442

RAIDER
Pro

HOT MELT GLUE GUN

RD-GLG03

• [BG] Пистолет за топло лепене • [RO] Pistol pentru lipit



Ø 1.3 mm 7 mm

30 W LIQUID 4.5 g/min

180 - 200 °C

4-5 min

ART.NO. BARCODE
076201 3800123162077

HOT MELT GLUE GUN

RD-GLG04

• [BG] Пистолет за топло лепене • [RO] Pistol pentru lipit



Ø 1.3 mm 11 mm

100 W LIQUID 12 g/min

180 - 200 °C

4-5 min

ART.NO. BARCODE
076202 3800123162084

HOT MELT GLUE GUN

RD-GL607

• [BG] Пистолет за топло лепене • [RO] Pistol pentru lipit



ART.NO.	BARCODE
076205	3800972012738

GLUE STICKS "CRISTAL"

RD

• [BG] Силиконови пръчки прозрачни • [RO] Batoane de silicon transparent

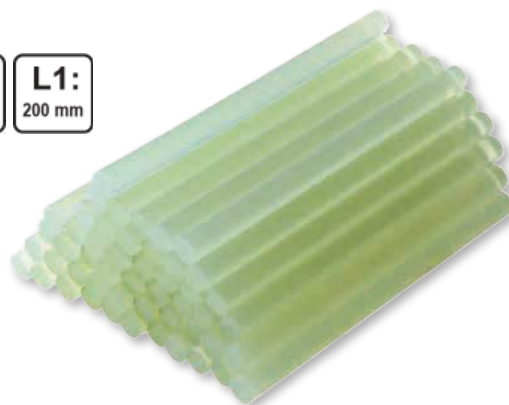

ART.NO.	BARCODE	SIZE
156701	3800123162251	Ø7x200 mm 8 pcs
156702	3800123162268	Ø7x200 mm 1 kg

GLUE STICKS "CRISTAL"

RD

• [BG] Силиконови пръчки прозрачни • [RO] Batoane de silicon transparent

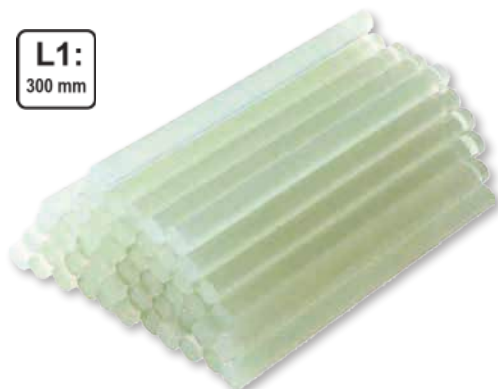

ART.NO.	BARCODE	SIZE
209910	3800123122354	Ø11x200 mm 6 pcs
209909	3800123122200	Ø11x300 mm 1 kg

GLUE STICKS BLACK

RD

• [BG] Силиконови пръчки черни • [RO] Batoane de silicon negru



ART.NO.	BARCODE	SIZE
156703	3800123162275	Ø7x200mm 8 pcs
156704	3800123162282	Ø11x200 mm 6 pcs
156705	3800123163357	Ø11x300 mm 1 kg



INVERTER WELDING MACHINE

RD-IW30

• [BG] Инверторен електрожен • [RO] Aparat de sudura invertor

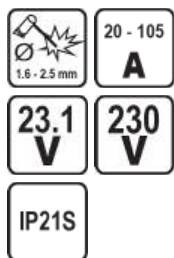

ART.NO. 077230
BARCODE 3800972024267

INVERTER WELDING MACHINE

RD-IW19

• [BG] Инверторен електрожен • [RO] Aparat de sudura invertor



ART.NO. 077204
BARCODE 3800123171826

INVERTER WELDING MACHINE

RD-IW160 E-LINE

• [BG] Инверторен електрожен • [RO] Aparat de sudura invertor



ART.NO. 077209
BARCODE 3800972015623

INVERTER WELDING MACHINE

RD-IW26

• [BG] Инверторен електрожен • [RO] Aparat de sudura invertor



ART.NO. 077210
BARCODE 3800972016248

INVERTER WELDING MACHINE

RD-IW25

• [BG] Инверторен електрожен • [RO] Aparat de sudura invertor



ART.NO. 077212
BARCODE 3800972016262



INVERTER WELDING MACHINE

RD-MIW160

• [BG] Инверторен електрожен • [RO] Aparat de sudura inverter

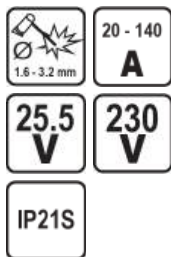

ART.NO. 077215
BARCODE 3800972034709

INVERTER WELDING MACHINE

RD-IW180 E-LINE

• [BG] Инверторен електрожен • [RO] Aparat de sudura inverter



ART.NO. 077213
BARCODE 3800972016279

INVERTER WELDING MACHINE

RD-MIW220

• [BG] Инверторен електрожен • [RO] Aparat de sudura inverter

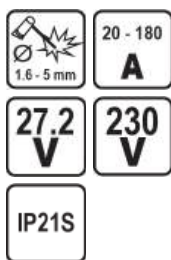

ART.NO. 077216
BARCODE 3800972034716

INVERTER WELDING MACHINE

RD-LMIW220

• [BG] Инверторен електрожен • [RO] Aparat de sudura inverter

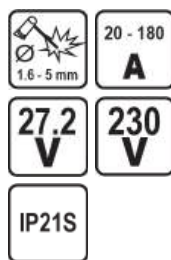

ART.NO. 077217
BARCODE 3800972034723

INVERTER WELDING MACHINE

RD-IW31

• [BG] Инверторен електрожен • [RO] Aparat de sudura inverter

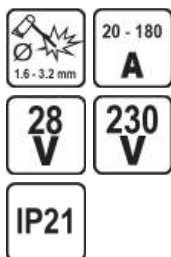

ART.NO. 077231
BARCODE 3800972026605

INVERTER WELDING MACHINE

RD-IW38

• [BG] Инверторен електрожен • [RO] Aparat de sudura inverter

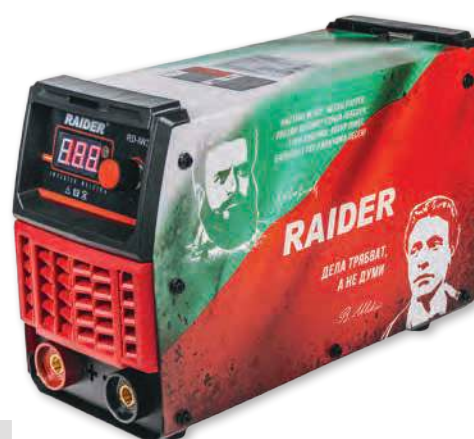
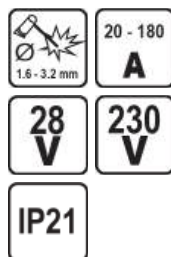

ART.NO. 077238
BARCODE 3800972032996

INVERTER WELDING MACHINE

RDP-IW34

• [BG] Инверторен електрожен • [RO] Aparat de sudura invertor



RAIDER
Pro

ART.NO. BARCODE
077234 3800972029538

INVERTER WELDING MACHINE

RD-IW220 E-LINE

• [BG] Инверторен електрожен • [RO] Aparat de sudura invertor



ART.NO. BARCODE
077214 3800972016286

INVERTER WELDING MACHINE

RDP-IW23

• [BG] Инверторен електрожен • [RO] Aparat de sudura invertor



RAIDER
Pro

ART.NO. BARCODE
077208 3800972004207

INVERTER WELDING MACHINE

RDP-IW35

• [BG] Инверторен електрожен • [RO] Aparat de sudura invertor



RAIDER
Pro

ART.NO. BARCODE
077235 3800972029545

INVERTER WELDING MACHINE

RDP-IW36

• [BG] Инверторен електрожен • [RO] Aparat de sudura invertor



RAIDER
Pro

ART.NO. BARCODE
077236 3800972029552

INVERTER WELDING MACHINE

RDP-IW37

• [BG] Инверторен електрожен • [RO] Aparat de sudura invertor



RAIDER
Pro

ART.NO. BARCODE
077237 3800972029569

INVERTER WELDING MACHINE

RD-IW41 E-LINE

• [BG] Инверторен електрожен • [RO] Aparat de sudura inverter



ART.NO. 077241
BARCODE 3800972048409

INVERTER WELDING MACHINE

RD-IW40

• [BG] Инверторен електрожен • [RO] Aparat de sudura inverter

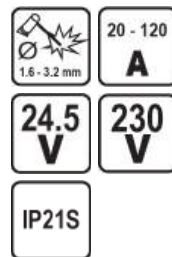

ART.NO. 077240
BARCODE 3800972034754

SELF SHIELDED FLUX CORED WELDING WIRE

RD

• [BG] Заваръчна флюсова тел
• [RO] Sarma pentru sudura cu autoprotectie si flux



ART.NO. 209942
BARCODE 3800972035065

INVERTER WELDING MACHINE

RD-IW27

• [BG] Инверторен електрожен • [RO] Aparat de sudura inverter



ART.NO. 077227
BARCODE 3800972020122

INVERTER WELDING MACHINE

RD-IW39

• [BG] Инверторен електрожен • [RO] Aparat de sudura inverter

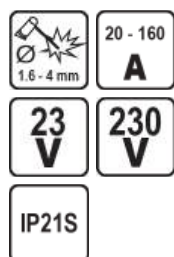

ART.NO. 077239
BARCODE 3800972033009

INVERTER WELDING MACHINE

RD-PCM29

• [BG] Инверторен електрожен • [RO] Aparat de sudura inverter

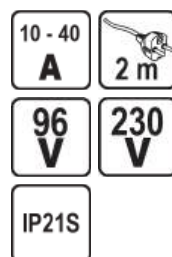

ART.NO. 077229
BARCODE 3800972020146

WELDING HELMET AUTO-DARKENING

RD-WH09

• [BG] Шлем заваръчен фотосоларен • [RO] Masca sudura cu auto-intunecare

SIZE
110x90 mm
mm



ART.NO.	BARCODE
138349	3800972035294

WELDING HELMET AUTO-DARKENING

RD-WH05

• [BG] Шлем заваръчен фотосоларен • [RO] Masca sudura cu auto-intunecare

SIZE
110x90 mm
mm



ART.NO.	BARCODE
138345	3800972027848

WELDING HELMET AUTO-DARKENING

RD-WH06

• [BG] Шлем заваръчен фотосоларен • [RO] Masca sudura cu auto-intunecare

SIZE
110x90 mm
mm



ART.NO.	BARCODE
138346	3800972027855

WELDING HELMET AUTO-DARKENING

RD-WH03

• [BG] Шлем заваръчен фотосоларен • [RO] Masca sudura cu auto-intunecare



ART.NO.	BARCODE
138307	3800972004405

WELDING HELMET AUTO-DARKENING

RD-WH08

• [BG] Шлем заваръчен фотосоларен • [RO] Masca sudura cu auto-intunecare



ART.NO.	BARCODE
138348	3800972030855

WELDING HELMET AUTO-DARKENING

RD-WH07

• [BG] Шлем заваръчен фотосоларен • [RO] Masca sudura cu auto-intunecare

SIZE
110x90 mm
mm



ART.NO.	BARCODE
	3800972027862

WELDING HELMET AUTO-DARKENING

RD-WH04

• [BG] Шлем заваръчен фотосоларен • [RO] Masca sudura cu auto-intunecare



ART.NO.	BARCODE
138309	3800972010260

WELDING FILTER WITH SOLAR CELLS

RD

• [BG] Филтър за заваръчен шлем • [RO] Filtru masca sudura cu celula solara

SIZE
110x90 mm
mm



ART.NO.	BARCODE
138305	3800123174315

FRONT PROTECTIVE LENS

RD-WH01, RD-WH02

• [BG] Екран външен предпазен • [RO] Geam protectie pt masca de sudura

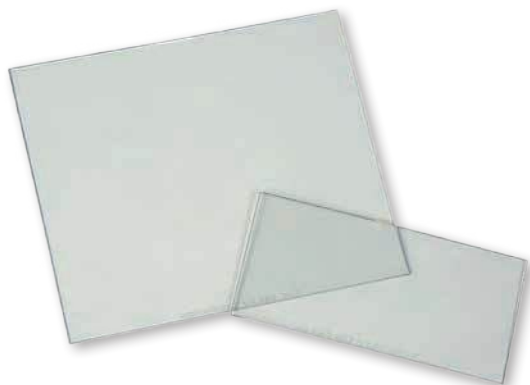

ART.NO.	BARCODE	SIZE
138303	3800123174292	116x89mm 5 pcs SET FOR RD-WH01
138306	3800123174322	108.5x89.5mm 5 pcs SET FOR RD-WH02
138304	3800123174308	100.4x46.4mm 5 pcs SET FOR RAIDER

ELECTRODE HOLDER

RD

• [BG] Електрододържател • [RO] Cleste electrozi sudura



ART.NO.	BARCODE	AMPERAGE
499923	3800123104138	300A
499924	3800123104121	500A

MAGNETIC WELDING GROUND CLAMP

RD

• [BG] Магнитна скоба маса за електрожен
• [RO] Cleste prindere ptr impamantare sudura

500
A



ART.NO.	BARCODE
157120	3800972045200

EARTH CLAMP

RD

• [BG] Щипка маса за електрожен • [RO] Cleste prindere ptr impamantare



ART.NO.	BARCODE
499930	3800123104145

ELECTRODE HOLDER & PLUG WITH WELDING CABLE

RD

- [BG] Електроддържател и конектор к-т
- [RO] Set cablu sudura cleste pentru electrozi si cupla



ART.NO. BARCODE
138343 3800972023697

EARTH CLAMP & PLUG WITH WELDING CABLE

RD

- [BG] Щипка маса с кабел и конектор к-т
- [RO] Set cablu sudura cleste pentru impamantare si cupla



ART.NO. BARCODE
138344 3800972023703

ARROW MAGNETIC WELDING HOLDER

RD

- [BG] Магнитен ъгъл държач
- [RO] Suport magnetic pentru sudura



ART.NO. BARCODE
138340 3800972009752

ARROW MAGNETIC WELDING HOLDER

RD

- [BG] Магнитен ъгъл държач
- [RO] Suport magnetic pentru sudura



ART.NO. BARCODE
138341 3800972009769

LASER DISTANCE METER

RD-LDM01

- [BG] Ролетка лазерна
- [RO] Telemetru cu laser



ART.NO. BARCODE
260802 3800972035447

ARROW MAGNETIC WELDING HOLDER

RD

- [BG] Магнитен ъгъл държач
- [RO] Suport magnetic pentru sudura

ART.NO. BARCODE
138342 3800972009776



SIZE
155x76 mm

MAGNET TORPEDO LEVEL

RD

- [BG] Нивелир с магнит
- [RO] Nivelă magnetica



ART.NO. BARCODE
549789 3800972002210

AUTOMATIC CROSS-LINE LASER

RD-CLG01

- [BG] Нивелир лазерен
- [RO] Nivelă laser



ART.NO. BARCODE
260803 3800972035454

ELECTRIC HOIST

RD-EH01

• [BG] Телфер електрически • [RO] Macara electrica



ART.NO. 121101
BARCODE 3800123120169

ELECTRIC HOIST

RD-EH02

• [BG] Телфер електрически • [RO] Macara electrica



ART.NO. 121102
BARCODE 3800123120084

ELECTRIC HOIST

RD-EH03

• [BG] Телфер електрически • [RO] Macara electrica



ART.NO. 121103
BARCODE 3800123120091

ELECTRIC HOIST TROLLEY

RD-EH05

• [BG] Релсова количка за телфер • [RO] Macara electrica

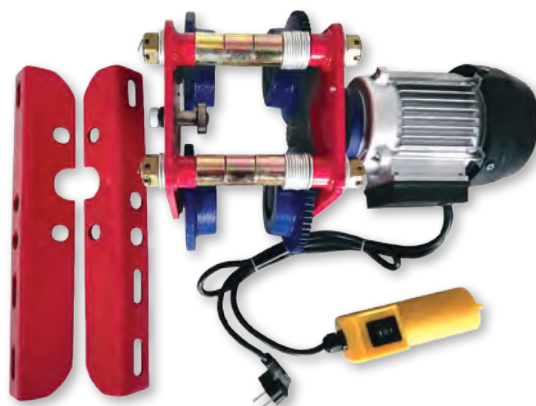

ART.NO. 079201
BARCODE 3800972016217

ELECTRIC HOIST TROLLEY

RD-EH06

• [BG] Релсова количка за телфер • [RO] Macara electrica

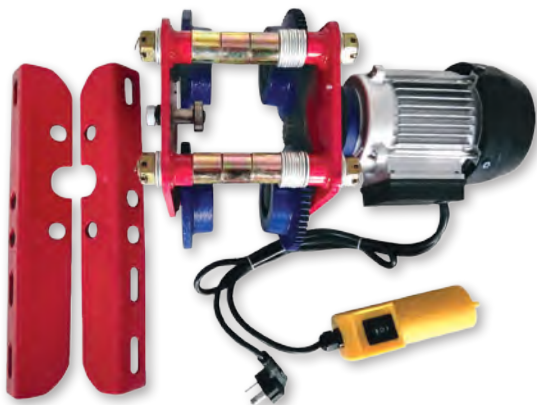

ART.NO. 079202
BARCODE 3800972016224

CHAIN BLOCK

RD

• [BG] Лебедка с верига • [RO] Scripete manual

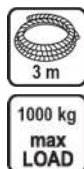

ART.NO. 300401
BARCODE 3800123120183

CHAIN BLOCK

RD

• [BG] Лебедка с верига • [RO] Scripete manual



2000 kg
max
LOAD



ART.NO. 300402
BARCODE 3800123120206

CHAIN BLOCK

RD

• [BG] Лебедка с верига • [RO] Scripete manual



3000 kg
max
LOAD



ART.NO. 300403
BARCODE 3800123120039

ELECTRIC WINCH

RD-EW09

• [BG] Автолебедка • [RO] Troliu electric



2200
W

1360 kg
max
LOAD

12
V



ART.NO. 121609
BARCODE 3800972032682

ELECTRIC WINCH

RD-EW10

• [BG] Автолебедка • [RO] Troliu electric



2760
W

1814 kg
max
LOAD

12
V



ART.NO. 121610
BARCODE 3800972032699

ELECTRIC WINCH

RD-EW11

• [BG] Автолебедка • [RO] Troliu electric



2722 kg
max
LOAD

2760
W

12
V



ART.NO. 121611
BARCODE 3800972032705

ELECTRIC WINCH

RD-EW07

• [BG] Автолебедка • [RO] Troliu electric



3628 kg
max
LOAD

12
V

3400
W



ART.NO. 121608
BARCODE 3800123119934

ELECTRIC WINCH

RD-EW12

• [BG] Автолебедка • [RO] Troliu electric



ART.NO. 121612
 BARCODE 3800972032712

INVERTER BATTERY CHARGER

RD-BC17

• [BG] Зарядно за акумулатор инверторно • [RO] Invertor Incarcator Baterie



ART.NO. 032206
 BARCODE 3800972027879

INVERTER BATTERY CHARGER

RD-BC18

• [BG] Зарядно за акумулатор инверторно • [RO] Invertor Incarcator Baterie



ART.NO. 032207
 BARCODE 3800972027886

INVERTER BATTERY CHARGER

RD-BC13

• [BG] Зарядно за акумулатор инверторно • [RO] Invertor Incarcator Baterie



ART.NO. 032202
 BARCODE 3800972002951

INVERTER BATTERY CHARGER

RD-BC19

• [BG] Зарядно за акумулатор инверторно • [RO] Invertor Incarcator Baterie



ART.NO. 032208
 BARCODE 3800972027893

BATTERY CHARGER

RD-BC05

• [BG] Зарядно за акумулатор • [RO] Redresor auto analog



ART.NO. 032201
 BARCODE 3800123162299

BATTERY CHARGER

RD-BC10

• [BG] Зарядно за акумулатор • [RO] Redresor auto analog



ART.NO. 129962
BARCODE 3800123152153

BATTERY CHARGER

RD-BC11

• [BG] Зарядно за акумулатор • [RO] Redresor auto analog

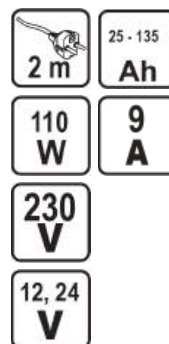

ART.NO. 129963
BARCODE 3800123152160

BATTERY CHARGER

RD-BC12

• [BG] Зарядно за акумулатор • [RO] Redresor auto analog



ART.NO. 129964
BARCODE 3800123152177

JUMP STARTER & POWER SUPPLY

RD-JBC15

• [BG] Зарядно стартерна батерия • [RO] Jump Starter Lanterna

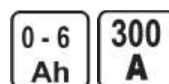

ART.NO. 032204
BARCODE 3800972002975

JUMP STARTER & POWER SUPPLY

RD-JBC16

• [BG] Зарядно стартерна батерия • [RO] Jump Starter Lanterna

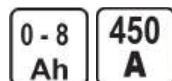

ART.NO. 032205
BARCODE 3800972002982

JUMP STARTER & POWER SUPPLY

RD-JBC20

• [BG] Зарядно стартерна батерия • [RO] Jump Starter Lanterna

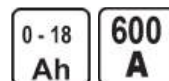

ART.NO. 032209
BARCODE 3800972027909

HYDRAULIC BOTTLE JACK

• [BG] Крик хидравличен тип "бутилка" • [RO] Cric hidraulic tip butelie



ART.NO.	BARCODE	CAPACITY	MODEL
300101	3800123136016	2 t	RD-HB02
300102	3800123136023	3 t	RD-HB03
300103	3800123136030	4 t	RD-HB04
300104	3800123136047	5 t	RD-HB05
300106	3800123136061	10 t	RD-HB10
300108	3800123136085	15 t	RD-HB15
300109	3800123136092	20 t	RD-HB20
300110	3800123136108	32 t	RD-HB32
300111	3800123136115	50 t	RD-HB50

HYDRAULIC BOTTLE JACK

• [BG] Крик хидравличен тип "бутилка" • [RO] Cric hidraulic tip butelie

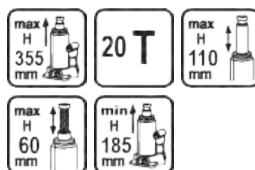

ART.NO.	BARCODE	CAPACITY	MODEL
300112	3800123173974	20 t	RD-HB20L

HYDRAULIC TROLLEY JACK

• [BG] Крик хидравличен тип "крокодил" • [RO] Cric crocodil



ART.NO.	BARCODE	CAPACITY	MIN-MAX LIFTING HEIGHT	MODEL
300201	3800123136139	2 t	130-300 mm	RD-TJ01
300207	3800123136504	2 t	130-300 mm	RD-TJ01
300202	3800123136146	2 t	125-390 mm	RD-TJ02
300209	3800123163968	2 t	85-380 mm	RD-TJ06
300205	3800123136245	3 t	135-400 mm	RD-TJ04
300204	3800123136153	3 t	120-495 mm	RD-TJ03
300208	3800123163845	3 t	135-500 mm	RD-TJ05

FARM JACK

RD-FJ01

• [BG] Крик високоповдигащ • [RO] Cric pentru off-road

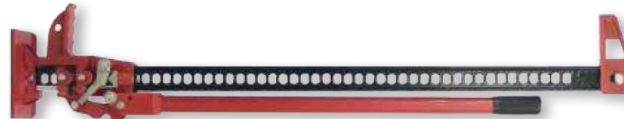

ART.NO.	BARCODE
309904	3800123173776

SCISSOR JACK

RD

• [BG] Крик винтов тип "жаба" • [RO] Cric foarfeca

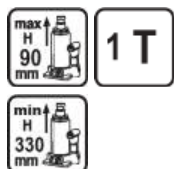

ART.NO.	BARCODE
309903	3800123154942

AXLE STANDS

RD

• [BG] Стойки за автомобил регулируема
• [RO] Stand pentru masina (capra) 2t set 2pcs



ART.NO.	BARCODE
300702	3800123136214

HYDRAULIC TIE & PULL BACK RAM TOOL KIT

RD-PHE03

• [BG] Разпъвачка за автомобили • [RO] Set hidraulic reparatii caroserii



ART.NO. 300612
BARCODE 3800123173783

HYDRAULIC BODY REPAIR KIT

RD-PHE04

• [BG] Разпъвачка хидравлична за автомобили • [RO] Set reparatii caroserie

max ↑
H 460
mm

10 T

min ↑
H 132
mm

1 pcs



ART.NO. 300613
BARCODE 3800972005679

HYDRAULIC BODY REPAIR KIT

RD-PHE05

• [BG] Разпъвачка хидравлична за автомобили • [RO] Set reparatii caroserie

max ↑
H 460
mm

4 T

min ↑
H 42
mm

1 pcs



ART.NO. 300614
BARCODE 3800972005686

HYDRAULIC BODY REPAIR KIT

RD-PHE06

• [BG] Разпъвачка хидравлична за автомобили • [RO] Set reparatii caroserie

max ↑
H 420
mm

15 T

min ↑
H 250
mm

1 pcs



ART.NO. 300615
BARCODE 3800972005693

HYDRAULIC BODY REPAIR KIT

RD-PHE07

• [BG] Разпъвачка хидравлична за автомобили • [RO] Set reparatii caroserie

max ↑
H 470
mm

20 T

min ↑
H 325
mm

1 pcs



ART.NO. 300616
BARCODE 3800972005709

HYDRAULIC FLOOR PRESS

RD-HP1

• [BG] Преса хидравлична
• [RO] Presa hidraulica

max ↑
H 395
mm

12 T



ART.NO. 300603
BARCODE 3800123128417

HYDRAULIC BENCH PRESS WITH PRESSURE GAUGE

RD-HP02

• [BG] Преса хидравлична • [RO] Presa hidraulica de banc cu indicator presiune

10 T



ART.NO.	BARCODE
300604	3800123173691

HYDRAULIC CYLINDER FOR HYDRAULIC BENCH PRESS WITH PRESSURE GAUGE

FOR RD-HP02

• [BG] Силов цилиндър за преса хидравлична
• [RO] Cilindru hidraulic pentru presa de banc

10 T



ART.NO.	BARCODE
309907	3800972025318

HYDRAULIC PRESS WITH PRESSURE GAUGE

RD-HP03

• [BG] Преса хидравлична
• [RO] Presa hidraulica de banc cu indicator presiune

12 T



ART.NO.	BARCODE
300605	3800123173707

HYDRAULIC CYLINDER FOR HYDRAULIC PRESS WITH PRESSURE GAUGE 12T RD-HP03

FOR RD-HP03

• [BG] Силов цилиндър за преса хидравлична
• [RO] Cilindru hidraulic pentru presa de banc

12 T



ART.NO.	BARCODE
309908	3800972025325

HYDRAULIC PRESS WITH PRESSURE GAUGE

RD-HP04

• [BG] Преса хидравлична
• [RO] Presa hidraulica cu manometru

max ↑
H
850
mm

20 T



ART.NO.	BARCODE
300606	3800123173714

PNEUMATIC PRESS WITH PRESSURE GAUGE

RD-HP05

• [BG] Преса пневматична
• [RO] Presa pneumatica cu manometru max 2

max ↑
H
850
mm

20 T



ART.NO.	BARCODE
300607	3800123173721

SINGLE CYLINDER TRANSMISSION JACK

RD-TRJ01

- [BG] Крик за скоростни кутии
- [RO] Cric tip suport transmisie



ART.NO. 300608
 BARCODE 3800123173738

HYDRAULIC PIPE BENDER

RD-HPB01

- [BG] Тръбогиб хидравличен
- [RO] Dispozitiv hidraulic pt indoire teava



ART.NO. 300610
 BARCODE 3800123173752

HYDRAULIC GEAR PULLER

3A RD-HGP01

- [BG] Скоба за лагери
- [RO] Dispozitiv hidraulic extractor cutie viteze



ART.NO. 300611
 BARCODE 3800123173769

HYDRAULIC ENGINE HOIST

RD

- [BG] Кран за повдигане на двигатели
- [RO] Macara hidraulica tip "Girafa"

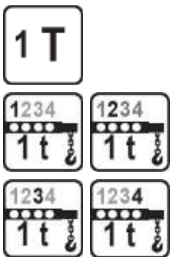

ART.NO. 309901
 BARCODE 3800123136221

ENGINE SUPPORT BAR

RD

- [BG] Греда за двигатели
- [RO] Bara suport pentru motor



ART.NO. 309902
 BARCODE 3800972032804



GASOLINE GENERATOR INVERTER

RD-GG23

- [BG] Генератор за ток бензинов инверторен
- [RO] Generator pe benzina Inverter



ART.NO. BARCODE
090123 3800972035546



GASOLINE GENERATOR INVERTER

RD-GG11

- [BG] Генератор за ток бензинов инверторен
- [RO] Generator pe benzina Inverter



ART.NO. BARCODE
090107 3800972023352

GASOLINE GENERATOR INVERTER

RD-GG24

- [BG] Генератор за ток бензинов инверторен тих
- [RO] Generator pe benzina Inverter



ART.NO. BARCODE
090124 3800972036505

GASOLINE GENERATOR INVERTER

RD-GG10

- [BG] Генератор за ток бензинов инверторен
- [RO] Generator pe benzina Inverter

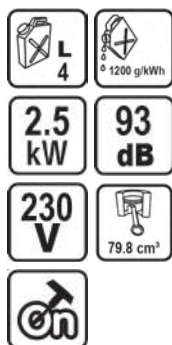

ART.NO. BARCODE
090105 3800972010666

GASOLINE GENERATOR INVERTER

RD-GG19

- [BG] Генератор за ток бензинов инверторен
- [RO] Generator pe benzina Inverter

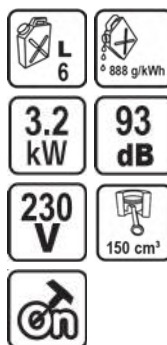

ART.NO. BARCODE
090119 3800972035478

GASOLINE GENERATOR INVERTER

RD-GG20

- [BG] Генератор за ток бензинов инверторен
- [RO] Generator pe benzina Inverter

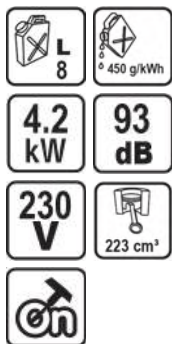

ART.NO. 090120
BARCODE 3800972035485

GASOLINE GENERATOR INVERTER

RD-GG13

- [BG] Генератор за ток бензинов инверторен
- [RO] Generator pe benzina Inverter



ART.NO. 090109
BARCODE 3800972028401

BATTERY

FOR RD-GG13

- [BG] Батерия оловна • [RO] Acumulator

7A



ART.NO. 090111
BARCODE 3800972028425

GASOLINE GENERATOR INVERTER

RD-GG21

- [BG] Генератор за ток бензинов инверторен
- [RO] Generator pe benzina Inverter

6.5 kW



ART.NO. 090121
BARCODE 3800972035492

GASOLINE GENERATOR INVERTER

RD-GG22

- [BG] Генератор за ток бензинов инверторен
- [RO] Generator pe benzina Inverter

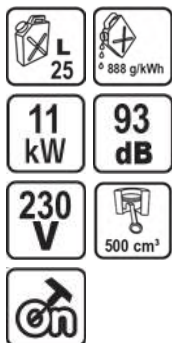

ART.NO. 090122
BARCODE 3800972035508

GASOLINE GENERATOR

RD-GG08

- [BG] Генератор за ток бензинов • [RO] Generator pe benzina

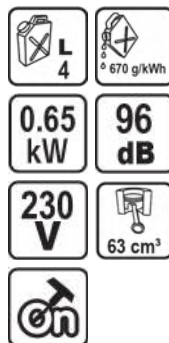

ART.NO. 090106
BARCODE 3800972010659

GASOLINE GENERATOR

RD-GG02

• [BG] Генератор за ток бензинов • [RO] Generator pe benzina

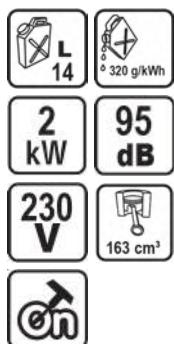

ART.NO.	BARCODE
129931	3800123145056

GASOLINE GENERATOR

RD-GG25

• [BG] Генератор за ток бензинов • [RO] Generator pe benzina



ART.NO.	BARCODE
090136	3800972039247

GASOLINE GENERATOR

RD-GG26

• [BG] Генератор за ток бензинов • [RO] Generator pe benzina

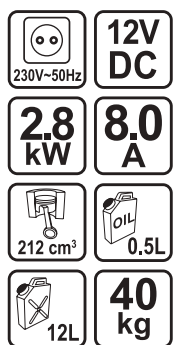

ART.NO.	BARCODE
090137	3800972039254

BATTERY

FOR RD-GG14 & 26

• [BG] Батерия оловна • [RO] Acumulator



ART.NO.	BARCODE
090138	3800972039261

GASOLINE GENERATOR

RD-GG06

• [BG] Генератор за ток бензинов • [RO] Generator pe benzina

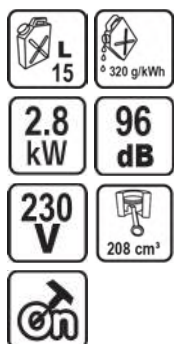

ART.NO.	BARCODE
090103	3800972000483

GASOLINE GENERATOR

RD-GG18

• [BG] Генератор за ток бензинов • [RO] Generator pe benzina

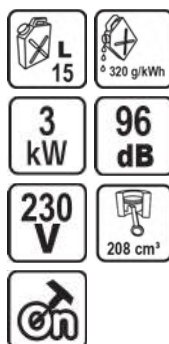

ART.NO.	BARCODE
090118	3800972035461

GASOLINE GENERATOR

RD-GG14

• [BG] Генератор за ток бензинов • [RO] Generator pe benzina



ART.NO. 090112
BARCODE 3800972031906

GASOLINE GENERATOR

RD-GG03

• [BG] Генератор за ток бензинов • [RO] Generator pe benzina



ART.NO. 129941
BARCODE 3800123120213

GASOLINE GENERATOR

RD-GG07

• [BG] Генератор за ток бензинов • [RO] Generator pe benzina

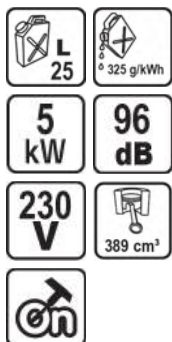

ART.NO. 090104
BARCODE 3800972000490

GASOLINE GENERATOR

RD-GG04

• [BG] Генератор за ток бензинов • [RO] Generator pe benzina



ART.NO. 090101
BARCODE 3800123169830

GASOLINE GENERATOR

RD-GG12

• [BG] Генератор за ток бензинов • [RO] Generator pe benzina

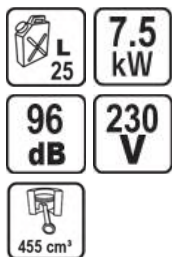

ART.NO. 090108
BARCODE 3800972028395

BATTERY

FOR RD-GG04 & GG12

• [BG] Батерия оловна • [RO] Acumulator

18A



ART.NO. 090110
BARCODE 3800972028418

GASOLINE GENERATOR

RD-GG28

• [BG] Генератор за ток бензинов • [RO] Generator pe benzina

7.5
kW



ART.NO. 090141
BARCODE 3800972044326

GASOLINE GENERATOR

RD-GG27

• [BG] Генератор за ток бензинов • [RO] Generator pe benzina

5.5
kW



ART.NO. 090140
BARCODE 3800972044319

DIESEL GENERATOR

RD-GG15

• [BG] Генератор Diesel ATS • [RO] Generator Diesel



ART.NO. 090115
BARCODE 3800972035171

BATTERY

FOR RD-GG15

• [BG] Батерия оловна • [RO] Acumulator

12V

36
Ah



ART.NO. 090116
BARCODE 3800972035188

AUTOMATIC TRANSFER SWITCH ATS

RD-ATS01

• [BG] Автоматичен превключвател ATS
• [RO] Comutator automat de transfer ATS pentru

10
kW

380
V



ART.NO. 090117
BARCODE 3800972035409

AUTOMATIC TRANSFER SWITCH ATS

RD-ATS02

• [BG] Автоматичен превключвател ATS
• [RO] Comutator automat de transfer ATS pentru

10
kW

400
V



ART.NO. 090142
BARCODE 3800972047273

FORWARD PLATE COMPACTOR

RDP-FPC01

• [BG] Виброплоча бензинова • [RO] Placa Compactor



ART.NO. 090125
BARCODE 3800972036758

BLOCK PAVING KIT

FOR RDP-FPC01

• [BG] Подложка за виброплоча • [RO] Kit pavaje pentru

540x480 mm



ART.NO. 090126
BARCODE 3800972036765

TAMPING RAMMER 1

RDP-TR01

• [BG] Бензинова трамбовка • [RO] Compactor

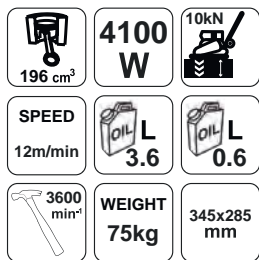

ART.NO. 090127
BARCODE 3800972036772

CONCRETE SCREED

RDP-SFCS01

• [BG] Вибромастар бензинов • [RO] Rigla vibranta pentru beton

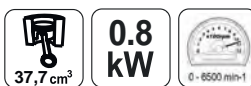

ART.NO. 090130
BARCODE 3800972036802

FLOOR SAW

RDP-FS01

• [BG] Бензинов фугорез колица • [RO] Motofierastrau pavaj



ART.NO. 090128
BARCODE 3800972036789

DIAMOND DISC

FOR RDP-FS01

• [BG] Диск диамантен за фугорез
• [RO] Disc diamanta pentru motofierastrau



ART.NO. 090129
BARCODE 3800972036796

BLADE

FOR RDP-SFCS01

• [BG] Профил 1m за вибромастар
• [RO] Lama pentru rigla vibranta beton



ART.NO. 090131
BARCODE 3800972036819
SIZE 1 m

ART.NO. 090132
BARCODE 3800972036826
SIZE 2 m

POWER TROWEL

RDP-GPT01

• [BG] Пердашка за бетон • [RO] Masina elicopterizare beton

6.5
HP

ø92
mm



ART.NO. BARCODE
090133 3800972036833

FINISH BLADES KIT FOR POWER TROWEL FOR RDP-GPT01

• [BG] Лопатки 4бр. к-т за пердашка за бетон RDP-GPT01 • [RO] Set lame pentru masina elicopterizare beton



ART.NO. BARCODE
090134 3800972036840

FLOAT DISC FOR POWER TROWEL FOR RDP-GPT01

• [BG] Тава за пердашка за бетон • [RO] Disc flotor pentru masina elicopterizare



ART.NO. BARCODE
090135 3800972036857

ELECTRIC CERAMIC FAN HEATER

RD-EFH16

• [BG] Калорифер електрически • [RO] Aeroterma electrica ceramica

150 m³/h
13 A
2000 W
230 V
IP24
30m³



ART.NO. BARCODE
078813 3800972028357

ELECTRIC CERAMIC FAN HEATER

RD-EFH07

• [BG] Калорифер електрически • [RO] Aeroterma electrica ceramica

150 m³/h
13 A
3000 W
230 V
SIZE
200x195x205 mm
mm
78m³



ART.NO. BARCODE
078807 3800972024083

ELECTRIC CERAMIC FAN HEATER

RD-EFH10

• [BG] Калорифер електрически • [RO] Aeroterma electrica ceramica

150 m³/h
13 A
2000 W
230 V
IP24
30m³



ART.NO. BARCODE
078814 3800972028364

ELECTRIC CERAMIC FAN HEATER

RD-EFH08

• [BG] Калорифер електрически • [RO] Aeroterma electrica ceramica

150 m³/h
13 A
3000 W
230 V
SIZE
265x200x205 mm
mm
78m³



ART.NO. BARCODE
078808 3800972024090

ELECTRIC CERAMIC FAN HEATER

RD-EFH02

• [BG] Калорифер електрически • [RO] Aeroterma electrica ceramica

 100 m³/h	8.7 A
2000 W	230 V
SIZE 230x220x115 mm	IP24
mm	
 20m³	



ART.NO. BARCODE
078801 3800123167874

ELECTRIC CERAMIC FAN HEATER

RD-EFH03

• [BG] Калорифер електрически • [RO] Aeroterma electrica ceramica

 150 m³/h	3000 W
230 V	SIZE 250x250x110 mm
IP24	mm
	 30m³



ART.NO. BARCODE
078806 3800123167911

ELECTRIC CERAMIC FAN HEATER

RD-EFH3.3

• [BG] Калорифер електрически • [RO] Aeroterma electrica ceramica

 150 m³/h	3300 W
230 V	SIZE 27x25.5x46 mm
IP24	mm
	 30m³



ART.NO. BARCODE
123303 3800123133886

ELECTRIC CERAMIC FAN HEATER

RD-EFH17

• [BG] Калорифер електрически • [RO] Aeroterma electrica ceramica

 800 m³/h	5000 W
230 V	SIZE 240x280x120 mm
IP24	mm
	 50m³





ART.NO. BARCODE
078817 3800972035539

ELECTRIC CERAMIC FAN HEATER

RD-EFH05

• [BG] Калорифер електрически • [RO] Aeroterma electrica ceramica

 200 m³/h	5000 W
400 V	SIZE 27x25.5x46 mm
IP24	mm
	 50m³



ART.NO. BARCODE
078803 3800123167881

ELECTRIC CERAMIC FAN HEATER

RD-EFH11

• [BG] Калорифер електрически • [RO] Aeroterma electrica ceramica

 150 m³/h	13 A
5000 W	230 V
IP24	SIZE 300x280x120 mm
	mm
	 30m³



ART.NO. BARCODE
078815 3800972028371

ELECTRIC CERAMIC FAN HEATER

RD-EFH09

• [BG] Калорифер електрически • [RO] Aeroterma electrica ceramica

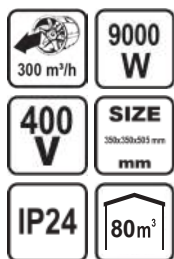

ART.NO. 078804
BARCODE 3800123167898

ELECTRIC CERAMIC FAN HEATER

RD-EFH15

• [BG] Калорифер електрически • [RO] Aeroterma electrica ceramica



ART.NO. 078805
BARCODE 3800123167904

PANEL HEATER

RD-PH01

• [BG] Конвектор със стойка • [RO] Panou Incalzitor 2



ART.NO. 078809
BARCODE 3800972027978

PANEL HEATER WHITE GLASS

RD-PH02

• [BG] Конвектор със стойка бяло стъкло • [RO] Panou Incalzitor 2



ART.NO. 078810
BARCODE 3800972027985

PANEL HEATER BLACK GLASS

RD-PH03

• [BG] Конвектор със стойка • [RO] Panou Incalzitor 2



ART.NO. 078811
BARCODE 3800972027992

PANEL HEATER BLACK GLASS

RD-PH04

• [BG] Конвектор със стойка • [RO] Panou Incalzitor 2



ART.NO. 078812
BARCODE 3800972028005

GAS HEATER

RD-GH10

• [BG] Калорифер газоз • [RO] Aeroterma pe gaz



ART.NO. BARCODE
450202 3800972039360

GAS HEATER

RD-GH1

• [BG] Калорифер газоз • [RO] Gas Heater



ART.NO. BARCODE
129973 3800123101809

GAS HEATER

RD-GH40

• [BG] Калорифер газоз • [RO] Gas Heater



ART.NO. BARCODE
450201 3800123167928

DIESEL SPACE HEATER

RD-DSH20

• [BG] Калорифер нафтоз • [RO] Generator aer cald diesel



ART.NO. BARCODE
078816 3800972028388

DIESEL SPACE HEATER

RD-DSH50

• [BG] Калорифер нафтоз • [RO] Generator aer cald diesel



ART.NO. BARCODE
123304 3800123133893

DIESEL SPACE HEATER

RD-DSH50-1

• [BG] Калорифер нафтоз • [RO] Generator aer cald diesel



ART.NO. BARCODE
123305 3800972035683

INDIRECT DIESEL SPACE HEATER

RDP-IDSH30

- [BG] Калорифер нафтов индиректен
- [RO] Generator aer cald diesel ardere indirecta

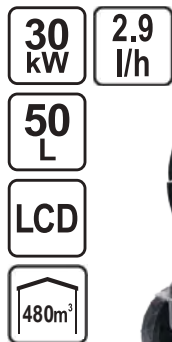

ART.NO. BARCODE
123307 3800972039605

INDIRECT DIESEL SPACE HEATER

RDP-IDSH60

- [BG] Калорифер нафтов индиректен
- [RO] Generator aer cald diesel ardere indirecta



ART.NO. BARCODE
123306 3800972035690

FAN

RD-F1

- [BG] Вентилатор • [RO] Ventilator



ART.NO. BARCODE
078901 3800972026698

FAN

RD-F2

- [BG] Вентилатор • [RO] Ventilator



ART.NO. BARCODE
078902 3800972026704



CHAIN SAW KIT FOR ANGLE GRINDER

RD

- [BG] Приставка резачка за ъглошлайф
- [RO] Chit drujsba pentru polizor unghiular



ART.NO. BARCODE
140129 3800972027077

GUIDE BAR FOR CHAIN SAW KIT FOR ANGLE GRINDER

RD

- [BG] Шина за резачка за ъглошлайф
- [RO] Lama drujsba pentru polizor unghiular

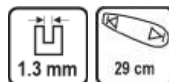

ART.NO. BARCODE
140130 3800972027084

ELECTRIC CHAIN SAW

RD-ECS21

- [BG] Резачка електрическа • [RO] Fierastrau electric cu lant



ART.NO. BARCODE
075115 3800972015418

ELECTRIC CHAIN SAW

RD-ECS32

- [BG] Резачка електрическа • [RO] Fierastrau electric cu lant



ART.NO. BARCODE
075127 3800972041974

ELECTRIC CHAIN SAW

RD-ECS28

- [BG] Резачка електрическа • [RO] Fierastrau electric cu lant



ART.NO. BARCODE
075123 3800972028449

ELECTRIC CHAIN SAW

RD-ECS16X

- [BG] Резачка електрическа • [RO] Fierastrau electric cu lant



ART.NO. BARCODE
075110 3800972002272

ELECTRIC CHAIN SAW

RD-ECS22

• [BG] Ресачка електрическа • [RO] Fierastrau electric cu lant



ART.NO. BARCODE
075116 3800972015425

ELECTRIC CHAIN SAW

RD-ECS23

• [BG] Ресачка електрическа • [RO] Fierastrau electric cu lant



ART.NO. BARCODE
075117 3800972015432

ELECTRIC CHAIN SAW

RD-ECS18X

• [BG] Ресачка електрическа • [RO] Fierastrau electric cu lant



ART.NO. BARCODE
075112 3800972002296

ELECTRIC CHAIN SAW

RD-ECS20X

• [BG] Ресачка електрическа • [RO] Fierastrau electric cu lant



ART.NO. BARCODE
075114 3800972014299

ELECTRIC CHAIN SAW

RD-ECS29

• [BG] Ресачка електрическа • [RO] Fierastrau electric cu lant



ART.NO. BARCODE
075124 3800972029965

ELECTRIC CHAIN SAW

RD-ECS24

• [BG] Ресачка електрическа • [RO] Fierastrau electric cu lant

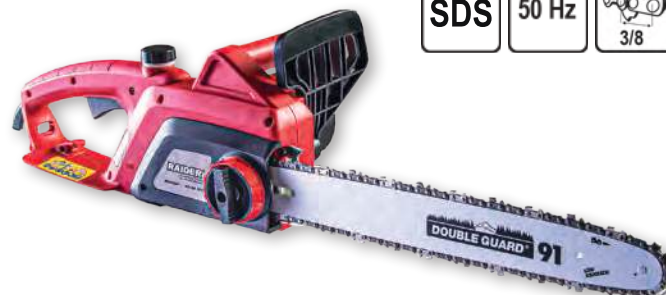

ART.NO. BARCODE
075118 3800972015449

ELECTRIC CHAIN SAW

RD-ECS31

• [BG] Ресачка електрическа • [RO] Fierastrau electric cu lant



ART.NO. BARCODE
075126 3800972041967

ELECTRIC CHAIN SAW

RD-ECS30

• [BG] Ресачка електрическа • [RO] Fierastrau electric cu lant



ART.NO. BARCODE
075125 3800972029972

ELECTRIC CHAIN SAW

RDP-ECS27

• [BG] Ресачка електрическа • [RO] Fierastrau electric cu lant



ART.NO. BARCODE
075120 3800972024496



GASOLINE CHAIN SAW CARVING GUIDE BAR

RDP-GCS28

• [BG] Ресачка бензинова • [RO] Motofierastrau



ART.NO. BARCODE
076710 3800972024342

CARVING GUIDE-BAR 2

3A RDP-GCS28

• [BG] Шина за верижен трион
• [RO] Sarma 1.4m pentru cutter spuma

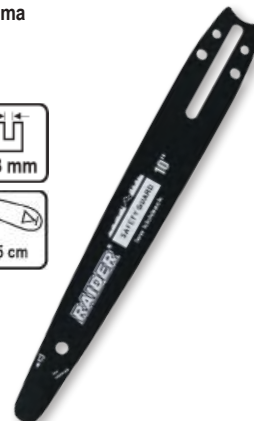

ART.NO. BARCODE
140146 3800972033474

SAW CHAIN

3A RDP-GCS28

• [BG] Верига за верижен трион
• [RO] Lant drujba

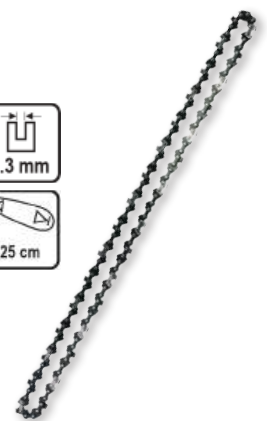

ART.NO. BARCODE
140147 3800972033481

GASOLINE CHAIN SAW

RD-GCS27

• [BG] Ресачка бензинова • [RO] Motofierastru



ART.NO. BARCODE
076709 3800972024328

GASOLINE CHAIN SAW

RD-GCS24

• [BG] Ресачка бензинова • [RO] Motofierastru

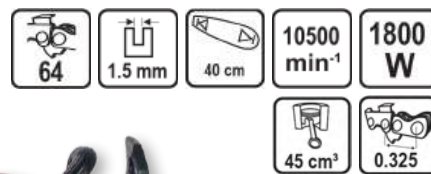

ART.NO. BARCODE
076706 3800972019423

GASOLINE CHAIN SAW

RD-GCS32

• [BG] Ресачка бензинова • [RO] Motofierastru



ART.NO. BARCODE
076713 3800972029767

GASOLINE CHAIN SAW

RD-GCS33

• [BG] Ресачка бензинова • [RO] Motofierastru

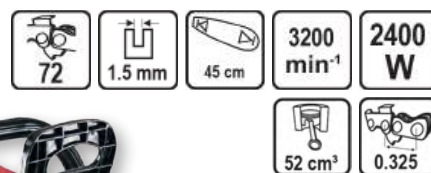

ART.NO. BARCODE
076714 3800972031746

GASOLINE CHAIN SAW

RD-GCS34

• [BG] Ресачка бензинова • [RO] Motofierastru



ART.NO. BARCODE
076715 3800972031739

GASOLINE CHAIN SAW

RD-GCS13

• [BG] Ресачка бензинова • [RO] Motofierastru

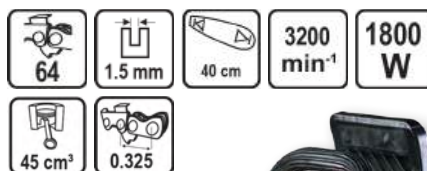

ART.NO. BARCODE
075104 3800123169847

GASOLINE CHAIN SAW

RD-GCS30

• [BG] Ресачка бензинова • [RO] Motofierastru

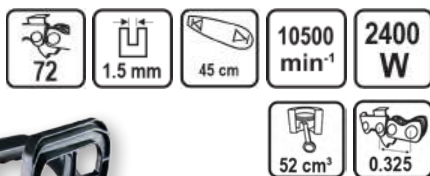

EasyOn



ART.NO. 076711
BARCODE 3800972026247

GASOLINE CHAIN SAW

RD-GCS15

• [BG] Ресачка бензинова • [RO] Motofierastru

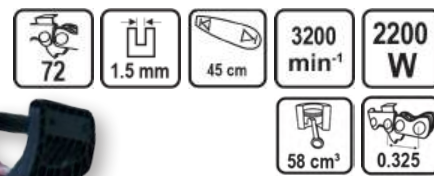

ART.NO. 075106
BARCODE 3800123169892

GASOLINE CHAIN SAW

RD-GCS20

• [BG] Ресачка бензинова • [RO] Motofierastru

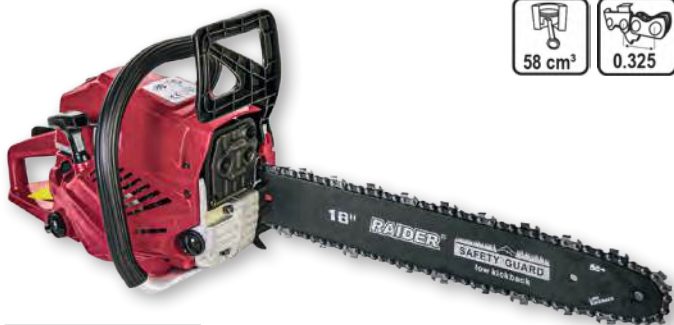
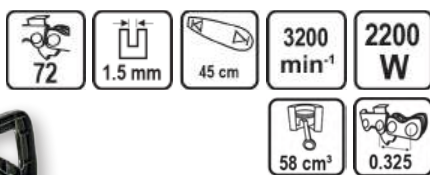

ART.NO. 076702
BARCODE 3800972004184

GASOLINE CHAIN SAW

RDP-GCS08

• [BG] Ресачка бензинова • [RO] Motofierastru

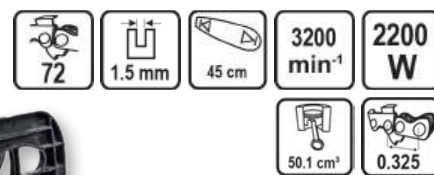

ART.NO. 129994
BARCODE 3800123133442

GASOLINE CHAIN SAW

RDP-GCS25

• [BG] Ресачка бензинова • [RO] Motofierastru

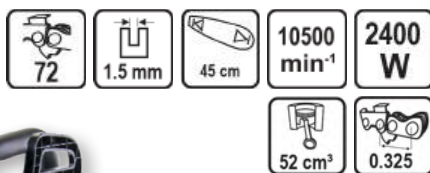

ART.NO. 076707
BARCODE 3800972019218

AIR FILTER

FOR RDP-GCS25

• [BG] Филтър въздушен • [RO] Filtru de aer



ART.NO. 140125
BARCODE 3800972019706

GASOLINE CHAIN SAW

RDP-GCS26

• [BG] Ресачка бензинова • [RO] Motofierastrau

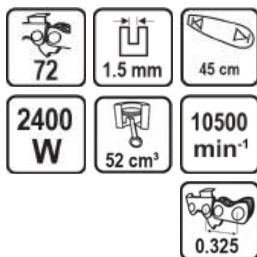

ART.NO. BARCODE
076708 3800972024236

GASOLINE CHAIN SAW

RDP-GCS3

• [BG] Ресачка бензинова • [RO] Motofierastrau

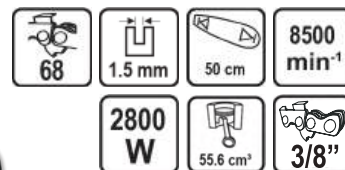

ART.NO. BARCODE
076716 3800972033498

GASOLINE CHAIN SAW

RDP-GCS36

• [BG] Ресачка бензинова • [RO] Motofierastrau



ART.NO. BARCODE
076717 3800972033504

GUIDE-BAR 50CM

FOR RDP-GCS36

• [BG] Шина за верижен трион
• [RO] Sina de ghidaj



ART.NO. BARCODE
140148 3800972033511

SAW CHAIN

FOR RDP-GCS36

• [BG] Верига за верижен трион
• [RO] Lant drijba

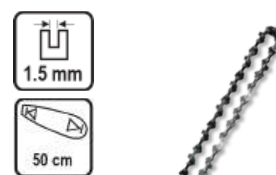

ART.NO. BARCODE
140149 3800972033528

GASOLINE CHAIN SAW

RDP-GCS23

• [BG] Ресачка бензинова • [RO] Motofierastrau

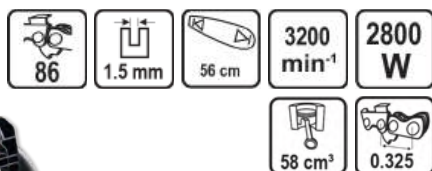

ART.NO. BARCODE
076705 3800972015487

CARRY BAG FOR CHAINSAWS

RD

• [BG] Чанта за верижен трион • [RO] Geanta textila pentru motofierastrau



ART.NO. BARCODE
549885 3800972025721

GASOLINE CHAIN SAW

RDP-GCS37

• [BG] Ресачка бензинова • [RO] Motofierastru

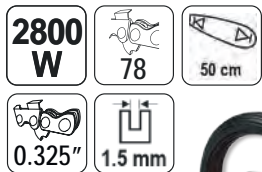

ART.NO.	BARCODE
076718	3800972044111

GASOLINE CHAIN SAW

RDP-GCS38

• [BG] Ресачка бензинова • [RO] Motofierastru

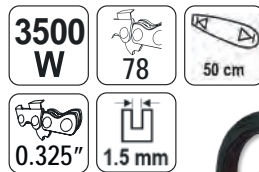

ART.NO.	BARCODE
076719	3800972044128

GUIDE-BAR 50CM

FOR RDP-GCS37, 38

• [BG] Шина за верижен трион • [RO] Sina de ghidaj



ART.NO.	BARCODE
076721	3800972044142

SAW CHAIN

FOR RDP-GCS37, 38

• [BG] Верига за верижен трион • [RO] Lant drujba



ART.NO.	BARCODE
076720	3800972044135



SAW CHAIN

• [BG] Верига за верижен трион • [RO] Lant drujba



ART.NO.	BARCODE	TYPE	FOR MODEL
140117	3800123174650	3/8".050" (1.3mm) 40 FOR 10"	RD-GCS18
140116	3800123174513	3/8".050" (1.3mm) 45 FOR 12"	RD-GCS18
140101	3800123162343	3/8".050" (1.3mm) 50	RD
140102	3800123162350	3/8".050" (1.3mm) 52	RD-ECS16X, 21 SBGS20
140103	3800123162367	3/8".050" (1.3mm) 56	RD
140104	3800123162374	3/8".050" (1.3mm) 57	RD-ECS17X, 18X, 19, 20, 22, 23 И 12
140124	3800972018013	3/8".050" (1.3mm) 57	RD-ECS17X, 18X, 19, 20 И 12 PROMO
140121	3800972015586	3/8".050" (1.3mm) 62	RD-ECS25
140139	3800972029996	450mm (18") 3/8".050" (1.3mm) 63	RD-ECS30
140120	3800972014343	.325".058" (1.5mm) 60	RD-GCS22
140105	3800123162381	.325".050" (1.3mm) 64	RD
140119	3800972004153	.325".058" (1.5mm) 64	RD-GCS13, 14 И 24
140106	3800123162398	.325".050" (1.3mm) 72	RD
140107	3800123162404	.325".058" (1.5mm) 72	RD-GCS15, 19, 20, 07, 08, 21 И 25
140123	3800972018006	.325".058" (1.5mm) 72	RD-GCS15, 19, 20, 07, 08, 21 И 25 PROMO
140122	3800972015593	.325".058" (1.5mm) 86	RDP-GCS23

GUIDE BAR

• [BG] Шина за верижен трион • [RO] Bara de ghidare



ART.NO.	BARCODE	TYPE	FOR MODEL
141308	3800123174643	10" 255mm 3/8" 1.3mm 40	RD-GCS18 & GCS27
141306	3800123174551	12" 305mm 3/8" 1.3mm 45	RD-GCS18
141316	3800972027626	14" 355mm 3/8".050" (1.3mm) 50	RD
141307	3800123174568	14" 355mm 3/8" 1.3mm 52	RD-ECS16X, 21
141314	3800972015647	OREGON 14" 350mm 3/8".050" (1.3mm) 52 SDS	RDP-SBGS20
141301	3800123162718	16" 400mm 3/8" 1.3mm 57	RD-ECS17X
141305	3800123174506	16" 400mm 3/8" 1.3mm 57	RD-ECS18X, 19, 20, 23, 24
141312	3800972015609	18" 450mm 3/8".050" (1.3mm) 62 SDS	RD-ECS25
141319	3800972029989	18" 450mm (18") SDS 3/8".050" (1.3mm) 63	RD-ECS30
141311	3800972014350	14" 355mm .325".058" (1.5mm)	RD-GCS22
141309	3800972002333	16" 400mm .325" 1.5mm 64	RD-GCS13 & 14
139964	3800123139956	18" 450mm .325" 1.5mm 72	RD-GCS15, 19, 20, 07, 08 И 21
141313	3800972015616	22" 560mm .325".058" (1.5mm) 86	RDP-GCS23

ELECTRIC SAW CHAIN SHARPENER

RD-CSS01

• [BG] Машина за точене на вериги • [RO] Pila electrica pentru

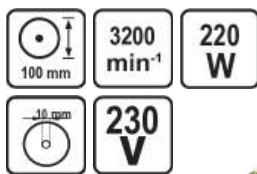

ART.NO.	BARCODE
140108	3800123163210

DISC FOR SAW CHAIN SHARPENER

RD

• [BG] Диск за машина за точене на вериги • [RO] Disc pentru pila ascutit lant

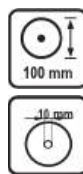

ART.NO.	BARCODE
140109	3800123163227

SAW CHAIN SHARPENER

RD

• [BG] Уред за точене на вериги • [RO] Dispozitiv pentru ascutit lant drujba



ART.NO.	BARCODE
075121	3800972025349

SHARPENING STONE 4 PCS. FOR SAW CHAIN SHARPENER

RD

• [BG] Сегмент резервен
• [RO] Set 4 pietre abrazive pentru dispozitivul de ascutit lant



ART.NO.	BARCODE
075122	3800972025356

GREASE GUN WITH GREASE FOR CHAIN SAW

RD

• [BG] Такаламит с грес за верижен трион
• [RO] Pistol de gresat pt. lama drujba



ART.NO.	BARCODE
141304	3800123167423

FILE KIT FOR 1/4"

RD

• [BG] Пила с водач • [RO] Set cu pila



ART.NO.	BARCODE
140151	3800972035591

FILE KIT FOR 3/8"

RD

• [BG] Пила с водач • [RO] Set cu pila



ART.NO. 140112
BARCODE 3800123167430

FILE KIT FOR 0.325"

RD

• [BG] Пила с водач • [RO] Set cu pila



ART.NO. 140113
BARCODE 3800123167447

POLISHING GALVANIZED LOG SAW TRESTLE

RD

• [BG] Стойка за рязане на дърва RD • [RO] Suport pentru taiat lemni



ART.NO. 140118
BARCODE 3800123174704

LOG SPLITTER

RD-LGS01

• [BG] Машина за цепене на дърва • [RO] Dispozitiv pentru despicat busteni



ART.NO. 129939
BARCODE 3800123123009

LOG SPLITTER

RD-LGS02

• [BG] Машина за цепене на дърва • [RO] Dispozitiv pentru despicat busteni



ART.NO. 060001
BARCODE 3800972020115

LOG SPLITTER

RD-LGS03

• [BG] Машина за цепене на дърва • [RO] Dispozitiv pentru despicat busteni

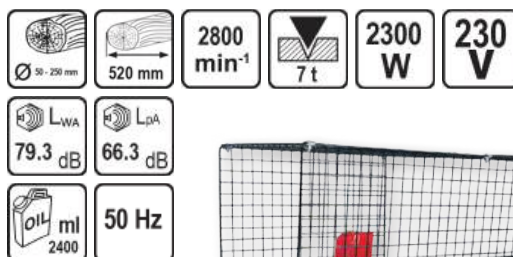

ART.NO. 060002
BARCODE 3800972032255

LOG SPLITTER

RD-LGS04

• [BG] Машина за цепене на дърва • [RO] Dispozitiv pentru despicat busteni



ART.NO. 060003
BARCODE 3800972032262

VERTICAL LOG SPLITTER

RD-LGS05

• [BG] Машина за цепене на дърва • [RO] Dispozitiv pentru despicat busteni



ART.NO. 060004
BARCODE 3800972032279

VERTICAL LOG SPLITTER

RD-LGS06

• [BG] Машина за цепене на дърва • [RO] Dispozitiv pentru despicat busteni



ART.NO. 060006
BARCODE 3800972041219

VERTICAL LOG SPLITTER

RD-LGS07

• [BG] Машина за цепене на дърва • [RO] Dispozitiv pentru despicat busteni



ART.NO. 060007
BARCODE 3800972041226

ELECTRIC BLOWER

RD-EBV03

• [BG] Листосъбирач • [RO] Sufianta frunze cu aspirare si tocator



ART.NO. 075522
BARCODE 3800972002074

ELECTRIC BLOWER

RD-EBV04

• [BG] Листосъбирач • [RO] Sufianta frunze cu aspirare si tocator



ART.NO. 075529
BARCODE 3800972002050

ELECTRIC BLOWER

RD-EBV05

• [BG] Листосъбирач • [RO] Sufianta frunze cu aspirare si tocator

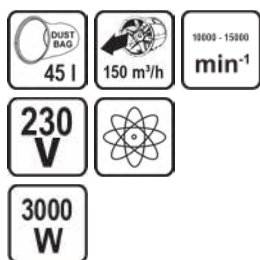

ART.NO. 075561
BARCODE 3800972031951

GASOLINE BLOWER VACUUM

RD-GBV06

• [BG] Листосъбирач бензинов
• [RO] Sufianta pe benzina cu aspirator si tocator

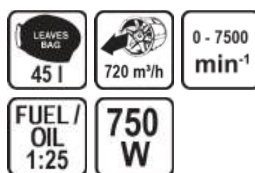

ART.NO. 077404
BARCODE 3800972027787

ELECTRIC BLOWER

RD-EBV08

• [BG] Листосъбирач • [RO] Sufianta frunze cu aspirare si tocator

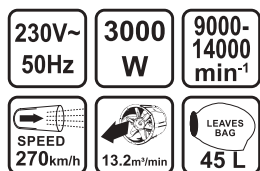

ART.NO. 075568
BARCODE 3800972040823

ELECTRIC BLOWER

RD-EBV09

• [BG] Листосъбирач • [RO] Sufianta frunze cu aspirare si tocator

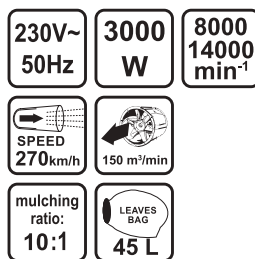

ART.NO. 075569
BARCODE 3800972040830

GASOLINE BLOWER

RD-GB10

• [BG] Моторна метла • [RO] Sufanta pe benzina

**ИДВА СКОРО
COMING SOON**

ART.NO.	BARCODE
077410	3800972047143

GASOLINE BLOWER

RD-GB06

• [BG] Моторна метла • [RO] Sufanta pe benzina



ml 1200	720 m³/h	0 - 2800 min⁻¹
SPEED 252 km/h	1250 W	FUEL / OIL 1:25

ART.NO.	BARCODE
077402	3800972015630

BAG FOR BLOWER VACUUM

• [BG] Торба за листосъбирач • [RO] Sac pentru suflanta



ART.NO.	BARCODE	VOLUME	FOR MODEL
075523	3800123173509	35 L	RD-EBV03
075562	3800972034358	45 L	RD-EBV03
075570	3800972041028	45 L	RD-EBV09

BAG FOR BLOWER VACUUM

RD-GBV05

• [BG] Торба за листосъбирач • [RO] Sac pentru suflanta



ART.NO.	BARCODE
140401	3800972003729



TILLER

RD-ET01J

• [BG] Мотофреза електрическа • [RO] Electroculcator

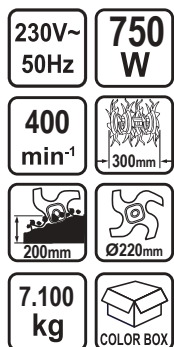

ART.NO. 095101
BARCODE 3800123163340

TILLER

RD-ET03

• [BG] Мотофреза електрическа • [RO] Electroculcator

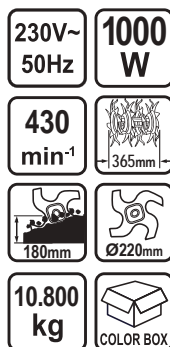

ART.NO. 095113
BARCODE 3800972003552

TILLER

RD-ET02

• [BG] Мотофреза електрическа • [RO] Electroculcator

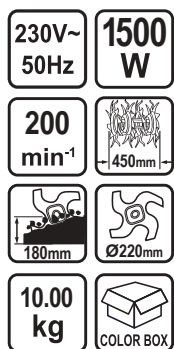

ART.NO. 095108
BARCODE 3800123174681

TILLER

RD-ET04

• [BG] Мотофреза електрическа • [RO] Electroculcator



ART.NO. 095117
BARCODE 3800972040632

GASOLINE TILLER

RD-T12

• [BG] Мотофреза бензинова • [RO] Motocultor

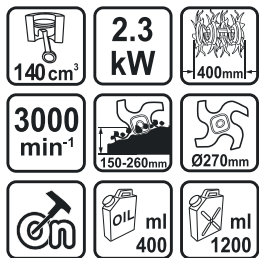

ART.NO. 076912
 BARCODE 3800972029255

GASOLINE TILLER

RD-ST17

• [BG] Мотофреза бензинова • [RO] Motocultor



ART.NO. 076917
 BARCODE 3800972040816

GASOLINE TILLER

RD-T08

• [BG] Мотофреза бензинова • [RO] Motocultor

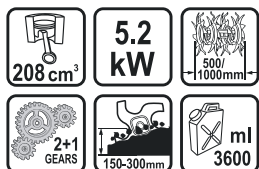

ART.NO. 076903
 BARCODE 3800972015203

GASOLINE TILLER

RD-WT14

• [BG] Мотофреза бензинова • [RO] Motocultor

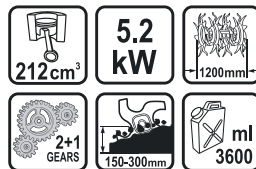

ART.NO. 076914
 BARCODE 3800972036161

GASOLINE TILLER

RD-WT16

• [BG] Мотофреза бензинова • [RO] Motocultor

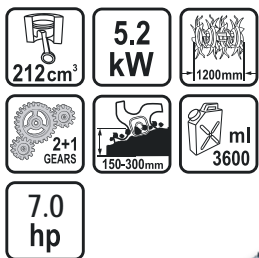

ART.NO. 076916
 BARCODE 3800972036185

GASOLINE TILLER

RD-T11

• [BG] Мотофреза бензинова • [RO] Motocultor

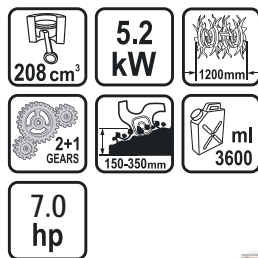

ART.NO. 076908
 BARCODE 3800972018037

GASOLINE TILLER

RD-T03

• [BG] Мотофреза бензинова • [RO] Motocultor

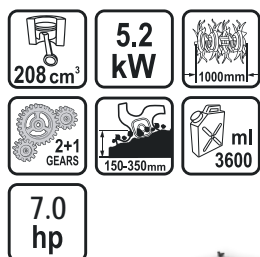

ART.NO. 095102
 BARCODE 3800123170867

GASOLINE TILLER

RD-WT15

• [BG] Мотофреза бензинова • [RO] Motocultor

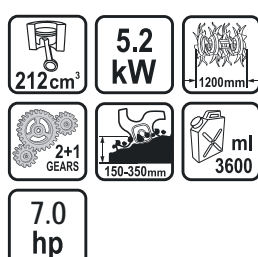

ART.NO. 076915
 BARCODE 3800972036178

GASOLINE TILLER

RD-T06

• [BG] Мотофреза бензинова • [RO] Motocultor

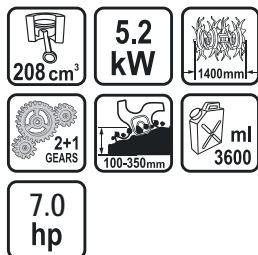

ART.NO. 095111
 BARCODE 3800972000834

GASOLINE TILLER

RD-T13

• [BG] Мотофреза бензинова • [RO] Motocultor

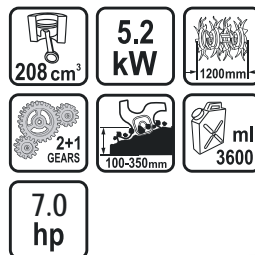

ART.NO. 095115
 BARCODE 3800972033535

GASOLINE TILLER

RD-T10

• [BG] Мотофреза бензинова • [RO] Motocultor

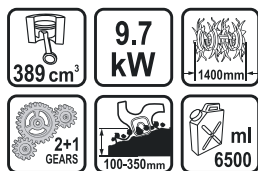

ART.NO. 076905
 BARCODE 3800972015579

TRAILER

RD

• [BG] Ремарке • [RO] Remorca



ART.NO. 076907
 BARCODE 3800123174544

EARTH AUGER

RD-EA01

• [BG] Моторен свредел • [RO] Motoburghiu

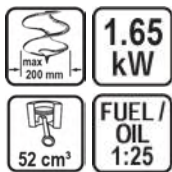

ART.NO.	BARCODE
095109	3800123174858

DRILL BIT FOR EARTH AUGER

FOR RD-EA01

• [BG] Свредло за моторен свредел
• [RO] Burgiu pt. foreza de pamant



ART.NO.	BARCODE	SIZE
110267	3800123174889	Ø100x800 mm
110268	3800123174896	Ø150x800 mm
110269	3800123174902	Ø200x800 mm

ANTI VIBRATION SYSTEM

FOR RD-EA01

• [BG] Приставка антивибрационна
• [RO] Cuplaj antivibratii pt. foreza



ART.NO.	BARCODE
110270	3800123174957

EARTH AUGER

RD-EA02

• [BG] Моторен свредел
• [RO] Motoburghiu

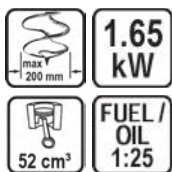

ART.NO.	BARCODE
095114	3800972017269

EARTH AUGER

RD-EA03

• [BG] Моторен свредел
• [RO] Motoburghiu

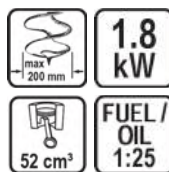

ART.NO.	BARCODE
095116	3800972036192

ELECTRIC SNOW THROWER

RD-ST02

• [BG] Снегорин електрически
• [RO] Freza electrica de zapada



ART.NO.	BARCODE
095106	3800123174100

BLOWER 2IN1

RD-EBV07

• [BG] Уред за обдухване • [RO] Sufianta frunze



ART.NO.	BARCODE
075567	3800972038127

GRASS TRIMMER

RD-GT26

• [BG] Косачка-тример • [RO] Trimmer pentru gazon



ART.NO. 075544
BARCODE 3800972009431

GRASS TRIMMER

RD-GT11Q

• [BG] Косачка-тример • [RO] Trimmer pentru gazon



ART.NO. 075507
BARCODE 3800123163173

TRIMMER LINE ON SPOOL WITH CAP

FOR RD-GT11 & 26

• [BG] Корда с макара и капачка за тример • [RO] Mosor fir trimmer fara suport



ART.NO. 110223
BARCODE 3800123163982

GRASS TRIMMER

RD-GT27

• [BG] Косачка-тример • [RO] Trimmer pentru gazon



ART.NO. 075563
BARCODE 3800972036086

TRIMMER LINE ON SPOOL WITH CAP FOR GRASS TRIMMER

RD-GT27

• [BG] Корда с макара и шайба за тример • [RO] Mosor fir trimmer fara suport



ART.NO. 110366
BARCODE 3800972036093

UNIVERSAL SAFETY GUARD FOR BRUSH CUTTERS

RD

• [BG] Предпазител универсален
• [RO] Aparatoare universală pentru motocoasă



ART.NO. 140150
BARCODE 3800972033573



ELECTRIC BRUSH CUTTER DETACHABLE SHAFT

RD-EBC15

• [BG] Коса електрическа • [RO] Motocoasa electrica

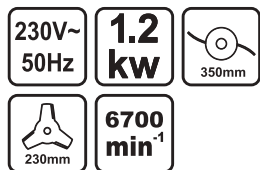

ART.NO. 075572
BARCODE 3800972041950

ELECTRIC BRUSH CUTTER DETACHABLE SHAFT

RD-EBC02

• [BG] Коса електрическа • [RO] Motocoasa electrica

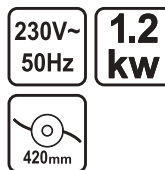

ART.NO. 075517
BARCODE 3800123171413

ELECTRIC BRUSH CUTTER DETACHABLE SHAFT

RD-EBC11

• [BG] Коса електрическа • [RO] Motocoasa electrica

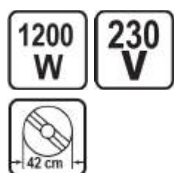

ART.NO. 075564
BARCODE 3800972036109

ELECTRIC BRUSH CUTTER DETACHABLE SHAFT

RD-EBC10

• [BG] Коса електрическа • [RO] Motocoasa electrica



ART.NO. 075560
BARCODE 3800972028609

ELECTRIC BRUSH CUTTER DETACHABLE SHAFT

RD-EBC14

• [BG] Коса електрическа • [RO] Motocoasa electrica

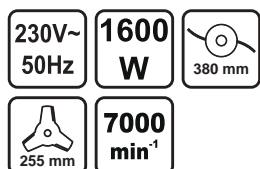

ART.NO. 075571
BARCODE 3800972041172

ELECTRIC BRUSH CUTTER 4 IN 1

RD-EBC12

• [BG] Коса електрическа • [RO] Motocoasa electrica

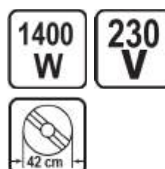

ART.NO. 075565
BARCODE 3800972036116

GASOLINE BRUSH CUTTER DETACHABLE SHAFT

RD-GBC22

• [BG] Коса бензинова • [RO] Motocoasa



ART.NO. 075549
BARCODE 3800972015463

GASOLINE BRUSH CUTTER

RD-GBC26

• [BG] Коса бензинова • [RO] Motocoasa



ART.NO. 075026
BARCODE 3800972035898

GASOLINE BRUSH CUTTER DETACHABLE SHAFT

RD-GBC20

• [BG] Коса бензинова • [RO] Motocoasa



ART.NO. 075543
BARCODE 3800972009035

GASOLINE BRUSH CUTTER DETACHABLE SHAFT

RD-GBC14

• [BG] Коса бензинова • [RO] Motocoasa



ART.NO. 075534
BARCODE 3800123174247

GASOLINE BRUSH CUTTER DETACHABLE SHAFT

RD-GBC24

• [BG] Коса бензинова • [RO] Motocoasa

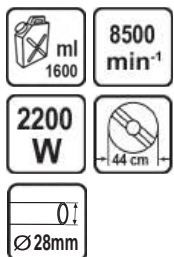

ART.NO. 075011
BARCODE 3800972020252

GASOLINE BRUSH CUTTER DETACHABLE SHAFT

RD-GBC27

• [BG] Коса бензинова • [RO] Motocoasa



ART.NO. 075027
BARCODE 3800972035904

GASOLINE BRUSH CUTTER

RDP-GBC15

• [BG] Коса бензинова • [RO] Motocoasa



ART.NO. BARCODE
075535 3800123174384

GASOLINE BRUSH CUTTER DETACHABLE SHAFT 4 IN 1

RD-GBC23

• [BG] Коса бензинова • [RO] Motocoasa



ART.NO. BARCODE
075010 3800972020214

GASOLINE BRUSH CUTTER DETACHABLE SHAFT 4 IN 1

RD-GBC25

• [BG] Коса бензинова • [RO] Motocoasa



ART.NO. BARCODE
075016 3800972029446

GASOLINE BRUSH CUTTER 4-STROKE

RD-GBC28

• [BG] Коса бензинова • [RO] Motocoasa



ART.NO. BARCODE
075566 3800972040625

GASOLINE POLE SAW DETACHABLE SHAFT

RD-GPS01

• [BG] Кастрчка бензинова • [RO] Motofierastrau



ART.NO. BARCODE
075555 3800972024304

EXTENSION POLE 1M FOR GASOLINE BRUSH CUTTER

RD

• [BG] Удължение 1m за бензинова коса
• [RO] Tijă extensie 1m pentru motocoasa



ART.NO. BARCODE
110289 3800972015500

GASOLINE BRUSH CUTTER DETACHABLE SHAFT

RD-GBC10

• [BG] Коса бензинова • [RO] Motocoasa



ART.NO. 075510
BARCODE 3800123166433

POLE SAW HEAD WITH TUBE FOR GASOLINE BRUSH CUTTER

FOR RD-GBC10

• [BG] Кастрачка за бензинова коса
• [RO] Cap drujba prelungitor pentru motocoasa



ART.NO. 110216
BARCODE 3800123161377

CHAIN FOR POLE SAW

FOR RD-GBC10

• [BG] Верига за кастрачка за бензинова коса • [RO] Lant pentru cap drujba



ART.NO. 140111
BARCODE 3800123166662

GUIDE-BAR FOR POLE SAW HEAD FOR GASOLINE BRUSH CUTTE

FOR RD-GBC10

• [BG] Шина за кастрачка за бензинова коса • [RO] Lama ghidaj pentru drujba

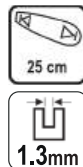

ART.NO. 141303
BARCODE 3800123166679

HEDGE TRIMMER HEAD WITH TUBE FOR GASOLINE BRUSH CUTTER

FOR RD-GBC10 & GBC11

• [BG] Храсторез за бензинова коса
• [RO] Cap trimmer gard viu pentru motocoasa

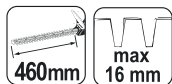

ART.NO. 110272
BARCODE 3800972001732

TILLER ATTACHMENT FOR GASOLINE BRUSH CUTTER

RD

• [BG] Фреза за бензинова коса • [RO] Sapatoare pentru motocoasa



ART.NO. 110288
BARCODE 3800972015494

POLE SAW

RD-PS01

- [BG] Кастрачка
- [RO] Fierastrau electric telescopic de taiat crengi 7

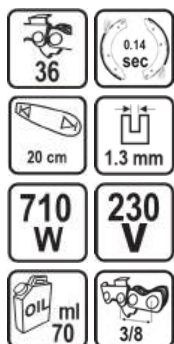

ART.NO.	BARCODE
075703	3800123163784

CHAIN FOR POLE SAW

RD-PS01

- [BG] Верига за кастрачка електрическа
- [RO] Lant pentru cap drujba

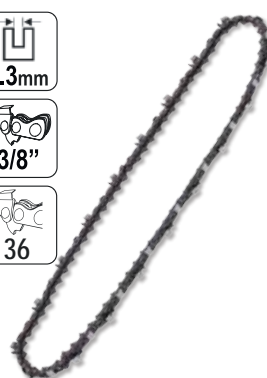

ART.NO.	BARCODE
140110	3800123163791

GUIDE-BAR FOR POLE SAW

RD-PS01

- [BG] Шина за кастрачка електрическа
- [RO] Lama ghidaj pentru drujba



ART.NO.	BARCODE
141302	3800123163807

POLE SAW & HEDGE TRIMMER

RD-PSHT02

- [BG] Кастрачка и Хросторез
- [RO] Fierastrau crengi si gard viu

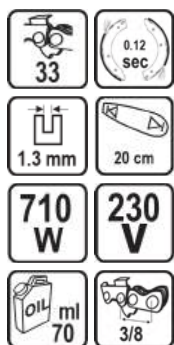

ART.NO.	BARCODE
075747	3800972030008

CHAIN FOR POLE SAW

RD-PS02

- [BG] Верига за кастрачка
- [RO] Lant pentru cap drujba



ART.NO.	BARCODE
140140	3800972030015

HAND PUSH LAWN MOWER 4

RD-HLM37

- [BG] Косачка ръчна
- [RO] Masina manuala de tuns iarba



ART.NO.	BARCODE
075342	3800972024243



LAWN MOWER

RD-LM30

• [BG] Косачка • [RO] Masina de tuns iarba



ART.NO. BARCODE
075330 3800972015517

BLADE FOR LAWN MOWER

RD-LM30

• [BG] Нож за косачка • [RO] Lama pentru masina de tuns iarba

32
cm



ART.NO. BARCODE
110294 3800972019485

GRASS BAG FOR LAWN MOWER

RD-LM30

• [BG] Кош за косачка • [RO] Sac pentru masina de tuns iarba



ART.NO. BARCODE
110352 3800972031449

LAWN MOWER

RD-LM36

• [BG] Косачка • [RO] Masina de tuns iarba



ART.NO. BARCODE
075340 3800972020207

SET LAWN MOWER

RD-LMGT01

• [BG] Комплект косачка и тример • [RO] Set masina de tuns iarba si trimer



ART.NO. BARCODE
075327 3800972009424

LAWN MOWER

RD-LM31

• [BG] Косачка • [RO] Masina de tuns iarba



ART.NO. BARCODE
075331 3800972015524

BLADE FOR LAWN MOWER

RD-LM31

• [BG] Нож за косачка
• [RO] Lama pentru masina de tuns iarba

33
cm



ART.NO. BARCODE
110295 3800972019492

GRASS BAG FOR LAWN MOWER

RD-LM31

• [BG] Кош за косачка
• [RO] Sac pentru masina de tuns iarba



ART.NO. BARCODE
110353 3800972031456

LAWN MOWER

RD-LM33

• [BG] Косачка • [RO] Masina de tuns iarba



ART.NO. BARCODE
075333 3800972015548

BLADE FOR LAWN MOWER

RD-LM33

• [BG] Нож за косачка
• [RO] Lama pentru masina de tuns iarba

38 cm



ART.NO. BARCODE
110297 3800972019515

GRASS BAG FOR LAWN MOWER

RD-LM33

• [BG] Кош за косачка
• [RO] Sac pentru masina de tuns iarba



ART.NO. BARCODE
110354 3800972031463

LAWN MOWER

RD-LM34

• [BG] Косачка • [RO] Masina de tuns iarba



ART.NO. BARCODE
075334 3800972015555

BLADE FOR LAWN MOWER

RD-LM34

• [BG] Нож за косачка
• [RO] Lama pentru masina de tuns iarba

43 cm



ART.NO. BARCODE
110298 3800972019522

GRASS BAG FOR LAWN MOWER

RD-LM34

• [BG] Кош за косачка
• [RO] Sac pentru masina de tuns iarba



ART.NO. BARCODE
110355 3800972031470



BRUSHLESS ROBOT LAWN MOWER

RD-RLM46

• [BG] Косачка робот безчеткова • [RO] Robot tuns gazon

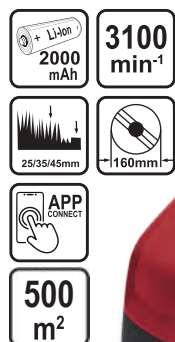

ART.NO. BARCODE
075366 3800972041080

BRUSHLESS ROBOT LAWN MOWER

RD-RLM44

• [BG] Косачка робот безчетков • [RO] Robot tuns gazon



ART.NO. BARCODE
075344 3800972029330

BRUSHLESS ROBOT LAWN MOWER

RD-RLM45

• [BG] Косачка робот безчеткова • [RO] Robot tuns gazon



ART.NO. BARCODE
075345 3800972029347

BATTERY 4AH FOR ROBOT MOWERS

RD-RLM44 & RLM45

• [BG] Батерия 4Ah за косачки робот
• [RO] Baterie 4Ah pentru robot de tuns gazon



ART.NO. BARCODE
075354 3800972035287

BLADES 3 PCS. FOR ROBOT MOWERS

FOR RD-RLM44 & RLM45

• [BG] Ножове 3 бр. за косачки робот
• [RO] Set 3 lame pentru robot de tuns gazon



ART.NO. BARCODE
075346 3800972029354

BOLTS 3 PCS. FOR BLADES FOR ROBOT MOWER

RD

• [BG] Болтчета 3 бр. за ножовете на косачки робот
• [RO] Set 3 bolturi prindere lame pentru robot tuns gazon



ART.NO. BARCODE
075371 3800972048355

BOUNDARY WIRE FOR ROBOT MOWERS FOR RD-RLM44 & RLM45

- [BG] Ограничителен кабел
- [RO] Fir perimetral 100m robot tuns gazon



ART.NO.	BARCODE
075347	3800972029361

WIRE BOUNDARY STAKES FOR RD-RLM44 & RLM45

- [BG] Скоби за кабел
- [RO] Set 130 tarusi pentru robot tuns gazon



ART.NO.	BARCODE
075348	3800972029378

CONNECTORS 2 PCS. FOR BOUNDARY WIRE - ROBOT FOR RD-RLM44 & RLM45

- [BG] Конектор 2 бр. за кабел за косачки робот
- [RO] Set 2 conectori pentru fir perimetral robot

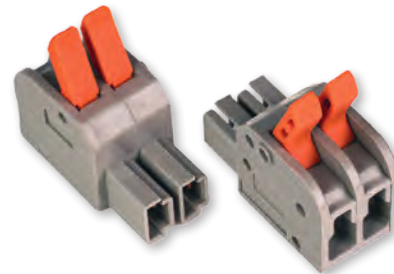

ART.NO.	BARCODE
075349	3800972029385

BRUSHLESS ROBOT LAWN MOWER RD-RLM47

- [BG] Косачка робот безчеткова • [RO] Robot tuns gazon

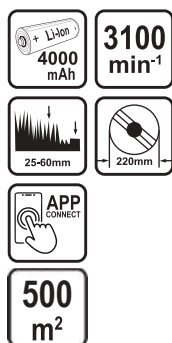

ART.NO.	BARCODE
075367	3800972041097

BATTERY 4AH FOR ROBOT MOWERS FOR RD-RLM47

- [BG] Батерия 4Ah за косачка робот
- [RO] Baterie 4Ah pentru robot de tuns gazon



ART.NO.	BARCODE
075370	3800972041127

UNIVERSAL GARAGE FOR ROBOT LAWN MOWER FOR RD-RLM47

- [BG] Гараж за косачка робот • [RO] Garaj universal pentru robot de tuns iarba



ART.NO.	BARCODE
075368	3800972041103

SOLAR PANEL FOR ROBOTIC LAWN MOWER FOR RD-RLM47

- [BG] Фотоволтаичен панел за зарядна станция
- [RO] Panou solar pentru robot de tuns gazon



ART.NO.	BARCODE
075369	3800972041110

SCARIFIER & AERATOR 2 IN 1

RD-ESCO1D

• [BG] Аератор • [RO] Scarificator 2 in 1



ART.NO. 075337
BARCODE 3800972015920

SCARIFIER & AERATOR 2 IN 1

RD-ESCO2

• [BG] Аератор • [RO] Scarificator 2 in 1



ART.NO. 075338
BARCODE 3800972015937

SHREDDER

RD-ESH01

• [BG] Клонотрошачка
• [RO] Tocator de crengi



ART.NO. 075336
BARCODE 3800972015944

BLADES 2 PCS. FOR SHREDDER

FOR RD-ESH01

• [BG] Ножове 2 бр. за клонотрошачка
• [RO] Set 2 lame pentru toicator vegetatie



ART.NO. 075362
BARCODE 3800972041035

SHREDDER

RD-ESH03

• [BG] Клонотрошачка
• [RO] Tocator de crengi



ART.NO. 075363
BARCODE 3800972033443

BLADES 2 PCS. FOR SHREDDER

FOR RD-ESH03

• [BG] Ножове 2 бр. за клонотрошачка
• [RO] Set 2 lame pentru toicator vegetatie



ART.NO. 075363
BARCODE 3800972041042

SHREDDER

RD-ESH02

- [BG] Клонотрошачка
- [RO] Tocator de crengi



ART.NO. BARCODE
075339 3800972015951



GASOLINE SHREDDER

RD-GSH03

- [BG] Клонотрошачка бензинова
- [RO] Tocator de crengi pe benzina



ART.NO. BARCODE
075360 3800972040878

BLADES 2 PCS. FOR SHREDDER

FOR RD-GSH03

- [BG] Ножове 2 бр. за клонотрошачка
- [RO] Set 2 lame pentru toicator vegetatie



ART.NO. BARCODE
075361 3800972040885

GASOLINE SHREDDER

RD-GSH01

- [BG] Клонотрошачка бензинова
- [RO] Tocator de crengi pe benzina



ART.NO. BARCODE
075351 3800972030695

BLADES 2 PCS. FOR SHREDDER

FOR RD-GSH01

- [BG] Ножове 2 бр. за клонотрошачка
- [RO] Set 2 lame pentru toicator vegetatie



ART.NO. BARCODE
075355 3800972036345

GASOLINE SHREDDER

RD-GSH02

- [BG] Клонотрошачка бензинова
- [RO] Tocator de crengi pe benzina



ART.NO. 075352
 BARCODE 3800972030701

BLADES 2 PCS. FOR SHREDDER

FOR RD-GSH02

- [BG] Ножове 2 бр. за клонотрошачка
- [RO] Set 2 lame pentru tocat vegetatie



ART.NO. 075356
 BARCODE 3800972036352

GASOLINE LAWN MOWER

RD-GLM01S

- [BG] Косачка бензинова
- [RO] Masina de tuns iarba pe benzina



ART.NO. 110105
 BARCODE 3800123141546

BLADE

FOR RD-GLM01S

- [BG] Нож за косачка бензинова
- [RO] Lama pentru masina de tuns iaba



ART.NO. 110203
 BARCODE 3800123141584

GRASS BAG

FOR RD-GLM01S

- [BG] Кош за косачка
- [RO] Sac pentru masina de tuns iarba



ART.NO. 110356
 BARCODE 3800972031487

GASOLINE LAWN MOWER

RD-GLM14

- [BG] Косачка бензинова
- [RO] Masina de tuns iarba pe benzina



ART.NO. 075014
 BARCODE 3800972029231

GASOLINE LAWN MOWER SELF PROPELLED

RD-GLM13

- [BG] Косачка бензинова самоходна
- [RO] Masina de tuns iarba pe benzina



ART.NO. 075013
 BARCODE 3800972029224

GASOLINE LAWN MOWER

RD-GLM15

- [BG] Косачка бензинова
- [RO] Masina de tuns iarba pe benzina

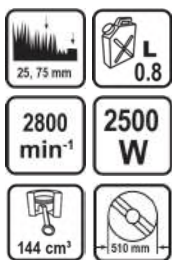

3in1



ART.NO. 075015
BARCODE 3800972029248



GASOLINE LAWN MOWER SELF-PROPELLED

RD-GLM07

- [BG] Косачка бензинова самоходна
- [RO] Masina de tuns iarba pe benzina



ART.NO. 075002
BARCODE 3800972015296

BLADE

FOR RD-GLM07

- [BG] Нож за косачка
- [RO] Lama pentru masina de tuns iarba

41
cm



ART.NO. 110300
BARCODE 3800972019546

GRASS BAG

FOR RD-GLM07

- [BG] Кош за косачка
- [RO] Sac pentru masina de tuns iarba

45L



ART.NO. 110357
BARCODE 3800972031494

GASOLINE LAWN MOWER SELF-PROPELLED

RD-GLM08

- [BG] Косачка бензинова самоходна
- [RO] Masina de tuns iarba pe benzina



ART.NO. 075003
BARCODE 3800972015289

BLADE

FOR RD-GLM08 & 05W

- [BG] Нож за косачка
- [RO] Lama pentru masina de tuns iarba

46
cm



ART.NO. 110301
BARCODE 3800972019553

GRASS BAG

FOR RD-GLM08

- [BG] Кош за косачка
- [RO] Sac pentru masina de tuns iarba

65L



ART.NO. 110358
BARCODE 3800972031500

GASOLINE LAWN MOWER SELF-PROPELLED

RD-GLM22

• [BG] Косачка бензинова самоходна • [RO] Masina de tuns iarba pe benzina



ART.NO. 075022
BARCODE 3800972040892

GASOLINE LAWN MOWER SELF-PROPELLED B&S

RD-GLM05W

• [BG] Косачка бензинова самоходна • [RO] Masina de tuns iarba pe benzina



ART.NO. 075012
BARCODE 3800972023864

GASOLINE LAWN MOWER SELF-PROPELLED

RD-GLM05

• [BG] Косачка бензинова самоходна • [RO] Masina de tuns iarba pe benzina



ART.NO. 075318
BARCODE 3800123174575

GASOLINE LAWN MOWER SELF-PROPELLED

RD-GLM23

• [BG] Косачка бензинова самоходна • [RO] Masina de tuns iarba pe benzina



ART.NO. 075023
BARCODE 3800972040908

GASOLINE LAWN MOWER SELF-PROPELLED

RD-GLM09

• [BG] Косачка бензинова самоходна • [RO] Masina de tuns iarba pe benzina



ART.NO. 075004
BARCODE 3800972015302

BLADE

FOR RD-GLM09

• [BG] Нож за косачка • [RO] Lama pentru masina de tuns iarba

51 cm



ART.NO. 110302
BARCODE 3800972019560

GRASS BAG

FOR RD-GLM09

• [BG] Кош за косачка • [RO] Sac pentru masina de tuns iarba

65L



ART.NO. 110359
BARCODE 3800972031517

GASOLINE LAWN MOWER SELF-PROPELLED

RD-GLM10

• [BG] Косачка бензинова самоходна • [RO] Masina de tuns iarba pe benzina



ART.NO. 075005
BARCODE 3800972015319

BLADE

FOR RD-GLM10

• [BG] Нож за косачка
• [RO] Lama pentru masina de tuns iarba

53 cm



ART.NO. 110307
BARCODE 3800972023369

GRASS BAG

FOR RD-GLM10

• [BG] Кош за косачка
• [RO] Sac pentru masina de tuns iarba



ART.NO. 110360
BARCODE 3800972031524

GASOLINE LAWN MOWER SELF-PROPELLED

RDP-GLM11

• [BG] Косачка бензинова самоходна • [RO] Masina de tuns iarba pe benzina

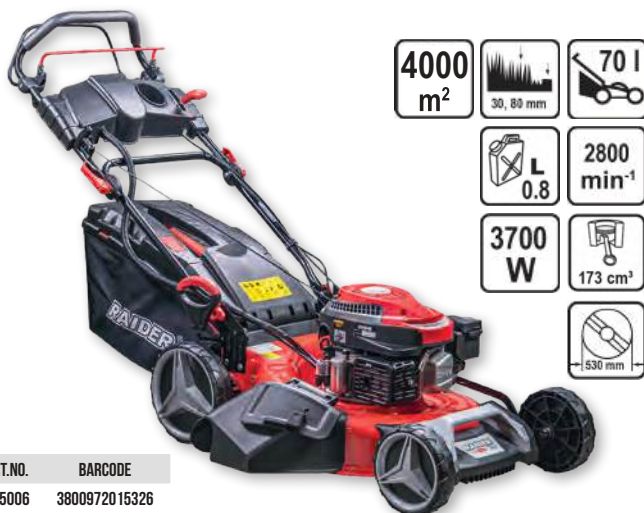

ART.NO. 075006
BARCODE 3800972015326

BLADE

FOR RDP-GLM11

• [BG] Нож за косачка
• [RO] Lama pentru masina de tuns iarba

53 cm



ART.NO. 110308
BARCODE 3800972023871

GRASS BAG

FOR RDP-GLM11

• [BG] Кош за косачка
• [RO] Sac pentru masina de tuns iarba



ART.NO. 110361
BARCODE 3800972031531

GASOLINE LAWN MOWER SELF-PROPELLED

RD-GLM12

• [BG] Косачка бензинова самоходна • [RO] Masina de tuns iarba pe benzina



ART.NO. 075007
BARCODE 3800972015333

BLADE

FOR RD-GLM12

• [BG] Нож за косачка
• [RO] Lama pentru masina de tuns iarba

56 cm



ART.NO. 110303
BARCODE 3800972019577

GRASS BAG

FOR RD-GLM12

• [BG] Кош за косачка
• [RO] Sac pentru masina de tuns iarba



ART.NO. 110362
BARCODE 3800972031548

DRUM MOWER

RD-DM01

• [BG] Косачка бензинова дискова • [RO] Motocositoare



ART.NO.	BARCODE
075017	3800972030718

BLADES FOR DRUM MOWER

FOR RD-DM01

• [BG] Ножове за дискова косачка • [RO] Set 4 lame pentru disc motocositoare



ART.NO.	BARCODE
110345	3800972030725

SICKLE BAR GASOLINE MOWER

RD-SBM02

• [BG] Косачка бензинова палцова • [RO] Motocositoare



ART.NO.	BARCODE
075020	3800972036154

BLADE SET FOR SICKLE BAR GASOLINE MOWER

FOR RD-SBM02

• [BG] Нож за палцова косачка
• [RO] Set lame pentru motocositoare pe benzina

**87
cm**

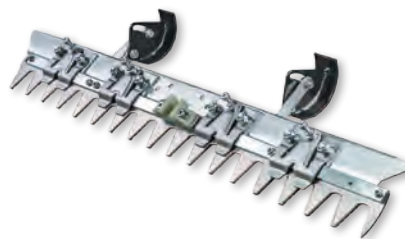

ART.NO.	BARCODE
075357	3800972036369

SICKLE BAR GASOLINE MOWER

RD-SBM01

• [BG] Косачка бензинова палцова • [RO] Motocositoare



ART.NO.	BARCODE
075008	3800972015340

BLADE SET FOR SICKLE BAR GASOLINE MOWER

FOR RD-SBM01

• [BG] Нож за палцова косачка
• [RO] Set lame pentru motocositoare pe benzina

**107
cm**



ART.NO.	BARCODE
110306	3800972020320

DRIVING CONNECTING ROD FOR RD-SBM01

• [BG] Планка задвижваща за палцова косачка
• [RO] Biela antrenoare pentru motocositoarea pe benzina



ART.NO.	BARCODE
110304	3800972020306

DRIVING CONNECTING ROD SET FOR RD-SBM01

• [BG] Планка задвижваща за палцова косачка
• [RO] Biela antrenoare pentru motocositoarea pe benzina



ART.NO.	BARCODE
110305	3800972020313

GARDEN TRACTOR

RD-GLM16

- [BG] Косачка тракторна
- [RO] Tractor de gradina



ART.NO. 075019
BARCODE 3800972031845

BLADE FOR GARDEN TRACTOR

FOR RD-GLM16

- [BG] Ножове за тракторна косачка
- [RO] Lama pentru tractor de gradina



ART.NO. 110365
BARCODE 3800972032422

GARDEN TRACTOR

RD-GLM17

- [BG] Косачка тракторна
- [RO] Tractor de gradina



ART.NO. 075021
BARCODE 3800972036277

BLADE FOR GARDEN TRACTOR

FOR RD-GLM17

- [BG] Ножове за тракторна косачка
- [RO] Lama pentru tractor de gradina



ART.NO. 110367
BARCODE 3800972036314

GASOLINE SCARIFIER 2IN1

RD-GSC03

- [BG] Аератор бензинов
- [RO] Scarificator benzina



ART.NO. 075009
BARCODE 3800972015357



HEDGE TRIMMER

RD-HT07

• [BG] Храсторез • [RO] Trimmer gard viu

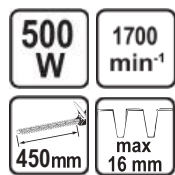

ART.NO. BARCODE
075755 3800972031913

HEDGE TRIMMER

RD-HT08

• [BG] Храсторез • [RO] Trimmer gard viu



ART.NO. BARCODE
075756 3800972031920

HEDGE TRIMMER

RD-HT09

• [BG] Храсторез • [RO] Trimmer gard viu



ART.NO. BARCODE
075757 3800972031937

HEDGE TRIMMER

RD-HT10

• [BG] Храсторез • [RO] Trimmer gard viu

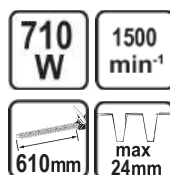

ART.NO. BARCODE
075758 3800972031944

GASOLINE HEDGE TRIMMER

RD-GHT02

• [BG] Храсторез • [RO] Trimmer pe benzina pentru gard viu



ART.NO. BARCODE
075702 3800123161384



KNAPSACK MIST DUSTER

RD-KMD02

- [BG] Пръскачка моторна
- [RO] Atomizor cu motor pe benzina



ART.NO. 098 101
 BARCODE 3800123174254

SPRAYER

RD-BMD05

- [BG] Пръскачка • [RO] Pulverizator



ART.NO. 098 108
 BARCODE 3800972033016

KNAPSACK SPRAYER

RD-BKMD04

- [BG] Пръскачка • [RO] Pulverizator



ART.NO. 098 103
 BARCODE 3800972009233

KNAPSACK SPRAYER

RD-BKMD03

- [BG] Пръскачка • [RO] Pulverizator



ART.NO. 098 102
 BARCODE 3800972009226

CHARGER

FOR RD-BKMD03 & 04

- [BG] Зарядно за пръскачка • [RO] Incarcator



ART.NO. 098 105
 BARCODE 3800972022584

BATTERY PACK FOR KNAPSACK SPRAYES

FOR RD-BKMD03 & 04

- [BG] Батерия за пръскачка • [RO] Acumulator



ART.NO. 098 104
 BARCODE 3800972022577

PRESSURE BOOSTING PUMP

RD-BP57

• [BG] Бустер помпа • [RO] Pompa ridicare presiune

1920 l/h H max 18 m
85 W 230 V



ART.NO. BARCODE
070164 3800972030053

PRESSURE BOOSTING PUMP

RD-CWP83

• [BG] Бустер помпа • [RO] Pompa ridicare presiune

1200 l/h H max 10 m
90 W 230 V
3/4"



ART.NO. BARCODE
070183 3800972032231

PRESSURE BOOSTING PUMP

RD-CWP84

• [BG] Бустер помпа • [RO] Pompa ridicare presiune

1200 l/h H max 10 m
90 W 230 V
3/4"



ART.NO. BARCODE
070184 3800972032248

CIRCULATION PUMP

RD-CWP81

• [BG] Помпа циркулационна • [RO] Pompa circulatie

3120 l/h H max 4 m
75 W 230 V



ART.NO. BARCODE
070181 3800972032217

CIRCULATION PUMP

RD-CWP82

• [BG] Помпа циркулационна • [RO] Pompa circulatie

3900 l/h H max 8 m
60 W 230 V



ART.NO. BARCODE
070182 3800972032224

PERIPHERAL PUMP

RD-PK60

• [BG] Помпа водна • [RO] Pompa de suprafata

2100 l/h S max 8 m 230 V
H max 35 m 3.5 bar
370 W
1"



ART.NO. BARCODE
070101 3800123123887

PERIPHERAL PUMP

RD-WP60

• [BG] Помпа водна • [RO] Pompa de suprafata

2400 l/h	S _{max} 8 m	230 V
H _{max} 35 m	3.5 bar	
500 W		
		



ART.NO. BARCODE
070115 3800123141539

HORIZONTAL CENTRIFUGAL PUMP

RD-CPM158

• [BG] Помпа водна • [RO] Pompa de suprafata

5760 l/h	S _{max} 8 m	
H _{max} 28 m	2.8 bar	
750 W	230 V	
		



ART.NO. BARCODE
070104 3800123123481

HORIZONTAL CENTRIFUGAL PUMP

RD-WP158

• [BG] Помпа водна • [RO] Pompa de suprafata

7200 l/h	S _{max} 8 m	
H _{max} 35 m	3.5 bar	
850 W	230 V	
		



ART.NO. BARCODE
070116 3800123141881

SELF-PRIMING PUMP JET

RD-JET100

• [BG] Помпа водна • [RO] Pompa de suprafata

2400 l/h	S _{max} 8 m	230 V	6 bar
H _{max} 60 m			
1100 W			
			



ART.NO. BARCODE
070117 3800123115875

SELF-PRIMING PUMP JET

RD-JET22

• [BG] Помпа водна
• [RO] Pompa cu autoamorsare

230V~ 50Hz	2200 W
S _{max} 8 m	H _{max} 70 m
	50 l/min
2850 min ⁻¹	



ART.NO. BARCODE
070118 3800972044876

HORIZONTAL CENTRIFUGAL PUMP

RD-1.5DK20

• [BG] Помпа водна • [RO] Pompa de suprafata

12600 l/h	S _{max} 9 m
H _{max} 20 m	2 bar
750 W	230 V
	



ART.NO. BARCODE
070103 3800123123511

HORIZONTAL CENTRIFUGAL PUMP

RD-2DK20

• [BG] Помпа водна • [RO] Pompa de suprafata

30000 l/h	S _{max} 9 m
H _{max} 20 m	1500 W
230 V	
	
2	



ART.NO. BARCODE
070105 3800123123528

SELF-PRIMING PUMP

RD-WP48

• [BG] Помпа водна • [RO] Pompa cu autoamorsare

3180 l/h	S _{max} 7 m	800 W
H _{max} 40 m		
230 V		
		
1		





ART.NO. BARCODE
070156 3800972029125

SELF-PRIMING PUMP

RDP-WP44

• [BG] Помпа водна • [RO] Pompa cu autoamorsare

35 m H _{max}	 600 W
 230 V	
	
1	



ART.NO. BARCODE
070152 3800972015760

SELF-PRIMING PUMP

RDP-WP57

• [BG] Помпа водна • [RO] Pompa cu autoamorsare

4800 l/h	S _{max} 8 m	1300 W
H _{max} 48 m		
230 V		
		
1		



ART.NO. BARCODE
070165 3800972030138

HORIZONTAL MULTISTAGE PUMP

RD-MSWP85

• [BG] Помпа водна • [RO] Pompa multietajata orizontala

5400 l/h	S _{max} 7 m	230 V
H _{max} 45 m		
		
1		



ART.NO. BARCODE
070185 3800972032590

HORIZONTAL MULTISTAGE PUMP

RD-MSWP86

• [BG] Помпа водна • [RO] Pompa multietajata orizontala

5400 l/h	S _{max} 8 m	1000 W
H _{max} 58 m		
230 V		
		
1		



ART.NO. BARCODE
070186 3800972032606

HORIZONTAL MULTISTAGE PUMP

RD-MSWP87

• [BG] Помпа водна • [RO] Pompa multietajata orizontala

5400 l/h	S _{max} 7 m
H _{max} 70 m	1350 W
230 V	
1	



ART.NO.	BARCODE
070187	3800972032613

SUBMERSIBLE PUMP FOR CLEAN WATER

RD-WP18

• [BG] Помпа водна потопяема за чиста вода • [RO] Pompa submersibila

10 m	1080 l/h
DP _{max} 7 m	H _{max} 60 m
300 W	230 V
3/4 "	



ART.NO.	BARCODE
070121	3800123161421

SUBMERSIBLE PUMP FOR CLEAN WATER

RD-WP19

• [BG] Помпа водна потопяема за чиста вода • [RO] Pompa submersibila

10 m	1080 l/h
DP _{max} 7 m	H _{max} 60 m
3/4 "	300 W
230 V	



ART.NO.	BARCODE
070122	3800123161438

SUBMERSIBLE PUMP FOR CLEAN WATER

RD-WP37

• [BG] Помпа водна потопяема за чиста вода • [RO] Pompa submersibila

10 m	3000 l/h
DP _{max} 7 m	H _{max} 10 m
3/4 "	350 W
230 V	



ART.NO.	BARCODE
070144	3800123174605

SUBMERSIBLE PUMP

RD-CAWP50

• [BG] Помпа водна потопяема • [RO] Pompa cu plutitor

8 m	2040 l/h
DP _{max} 7 m	H _{max} 14 m
1 "	370 W
230 V	



ART.NO.	BARCODE
070157	3800972029453

SUBMERSIBLE PUMP

RD-CAWP51

• [BG] Помпа водна потопяема • [RO] Pompa cu plutitor

8 m	3000 l/h
DP _{max} 7 m	H _{max} 17 m
1 "	550 W
230 V	



ART.NO.	BARCODE
070158	3800972029460

SUBMERSIBLE PUMP

RD-CAWP52

• [BG] Помпа водна потопяема • [RO] Pompa cu plutitor

 8 m	 3000 l/h
 DP max 7 m	 H max 20 m
 1"	 750 W
 230 V	









ART.NO. 070159
BARCODE 3800972029477

SUBMERSIBLE PUMP

RD-CAWP53

• [BG] Помпа водна потопяема • [RO] Pompa cu plutitor

 8 m	 3000 l/h
 DP max 7 m	 H max 32 m
 1"	 900 W
 230 V	









ART.NO. 070160
BARCODE 3800972029484

SUBMERSIBLE PUMP FOR SEWAGE WATER

RD-CAWP54

• [BG] Помпа водна потопяема за мръсна вода • [RO] Pompa cu plutitor

 8 m	 12000 l/h
 DP max 7 m	 H max 9 m
 2"	 750 W
 230 V	









ART.NO. 070161
BARCODE 3800972029491

SUBMERSIBLE PUMP FOR SEWAGE WATER

RD-CAWP55

• [BG] Помпа водна потопяема за мръсна вода • [RO] Pompa cu plutitor

 8 m	 13800 l/h
 DP max 7 m	 H max 9 m
 2"	 1100 W
 230 V	









ART.NO. 070162
BARCODE 3800972029507

SUBMERSIBLE PUMP FOR SEWAGE WATER

RD-CAWP56

• [BG] Помпа водна потопяема за мръсна вода • [RO] Pompa cu plutitor

 8 m	 18000 l/h
 DP max 7 m	 H max 13 m
 2"	 1100 W
 230 V	









ART.NO. 070163
BARCODE 3800972029514

SUBMERSIBLE PUMP FOR SEWAGE WATER

RD-NWP88

• [BG] Помпа водна потопяема за мръсна вода • [RO] Pompa cu plutitor

 8 m	 13800 l/h
 DP max 7 m	 H max 15 m
 2"	 1100 W
 230 V	



ART.NO. 070188
BARCODE 3800972032644

SUBMERSIBLE PUMP FOR SEWAGE WATER

RD-AWP90

• [BG] Помпа водна потопяема за мръсна вода • [RO] Pompa cu plutitor

2200 W	H max 26m
8m	133 L/min



ART.NO. BARCODE
070202 3800972044883

SUBMERSIBLE PUMP FOR SEWAGE WATER

RD-WP46

• [BG] Помпа водна потопяема за мръсна вода • [RO] Pompa cu plutitor

10m	7500 l/h
DP max 7m	H max 5m
1"	400 W
230 V	



ART.NO. BARCODE
070154 3800972029101

SUBMERSIBLE PUMP FOR SEWAGE WATER

RD-WP47

• [BG] Помпа водна потопяема за мръсна вода • [RO] Pompa cu plutitor

10m	7500 l/h
DP max 7m	H max 5m
1"	400 W
230 V	



ART.NO. BARCODE
070155 3800972029118

SUBMERSIBLE PUMP FOR SEWAGE WATER

RDP-WP42

• [BG] Помпа водна потопяема за мръсна вода • [RO] Pompa cu plutitor

10m	35mm
400W	5m H max
230V	1"



ART.NO. BARCODE
070150 3800972015746

SUBMERSIBLE PUMP FOR SEWAGE WATER

RD-WP67

• [BG] Помпа водна потопяема за мръсна вода • [RO] Pompa cu plutitor

10m	35mm
11400 l/h	DP max 5m
H max 7m	1"
550 W	230 V



ART.NO. BARCODE
070174 3800972030305

SUBMERSIBLE PUMP FOR SEWAGE WATER

RD-WP63

• [BG] Помпа водна потопяема за мръсна вода • [RO] Pompa cu plutitor

10m	35mm
12480 l/h	DP max 7m
H max 7m	1"
550 W	230 V





ART.NO. BARCODE
070170 3800972030268

SUBMERSIBLE PUMP FOR SEWAGE WATER

RD-WP59

• [BG] Помпа водна потопяема за мръсна вода • [RO] Pompa cu plutitor

 10 m	 35 mm
12480 l/h	DP max 7 m
H max 7 m	 1"
550 W	230 V



ART.NO. 070167
BARCODE 3800972030152

SUBMERSIBLE PUMP FOR SEWAGE WATER

RD-WP72

• [BG] Помпа водна потопяема за мръсна вода • [RO] Pompa cu plutitor

 10 m	 35 mm
13980 l/h	DP max 7 m
H max 8 m	 1"
750 W	230 V





ART.NO. 070179
BARCODE 3800972031692

SUBMERSIBLE PUMP FOR SEWAGE WATER

RD-WP64

• [BG] Помпа водна потопяема за мръсна вода • [RO] Pompa cu plutitor

 10 m	 20 mm
13980 l/h	DP max 7 m
H max 8 m	 1"
750 W	230 V





ART.NO. 070171
BARCODE 3800972030275

SUBMERSIBLE PUMP FOR SEWAGE WATER

RD-WP68

• [BG] Помпа водна потопяема за мръсна вода • [RO] Pompa cu plutitor

 10 m	 35 mm
15000 l/h	DP max 7 m
H max 8.5 m	 1"
900 W	230 V





ART.NO. 070175
BARCODE 3800972030312

SUBMERSIBLE PUMP FOR SEWAGE WATER

RD-WP61

• [BG] Помпа водна потопяема за мръсна вода • [RO] Pompa cu plutitor

 10 m	 35 mm
15000 l/h	DP max 7 m
H max 8.5 m	 1"
900 W	230 V





ART.NO. 070168
BARCODE 3800972030169

SUBMERSIBLE PUMP FOR SEWAGE WATER

RD-WP62

• [BG] Помпа водна потопяема за мръсна вода • [RO] Pompa cu plutitor

 10 m	 35 mm
19980 l/h	DP max 7 m
H max 9 m	 1"
1100 W	230 V





ART.NO. 070169
BARCODE 3800972030176

SUBMERSIBLE PUMP FOR SEWAGE WATER

RD-WP65

• [BG] Помпа водна потопяема за мръсна вода • [RO] Pompa cu plutitor

 10 m	 20 mm
19980 l/h	DP max 7 m
H max 9 m	 1"
1100 W	230 V



ART.NO. 070172
BARCODE 3800972030282

SUBMERSIBLE PUMP FOR SEWAGE WATER

RDP-WP27

• [BG] Помпа водна потопяема за мръсна вода • [RO] Pompa cu plutitor

 10 m	 35 mm
11 m H max	 2"
1300 W	 230 V





ART.NO. 070134
BARCODE 3800123166181

SUBMERSIBLE PUMP

RD-WP58

• [BG] Помпа водна потопяема за чиста вода • [RO] Pompa cu plutitor inc

 10 m	 5 mm
15000 l/h	DP max 7 m
H max 9 m	 1 1/4"
900 W	230 V



ART.NO. 070166
BARCODE 3800972030145

SUBMERSIBLE PUMP FOR SEWAGE WATER

RD-WP73

• [BG] Помпа водна потопяема за мръсна вода • [RO] Pompa cu plutitor inc

 30 mm	15000 l/h
DP max 7 m	H max 8 m
900 W	230 V



ART.NO. 070198
BARCODE 3800972039124

SUBMERSIBLE SCREW PUMP FOR CLEAN WATER

RD-WP74

• [BG] Помпа водна дълбочинна винтова за чиста вода
• [RO] Pompa submersibila cu snec

 20 m	1900 l/h
H max 116 m	 1"
900 W	230 V
S max 30 m	



ART.NO. 070200
BARCODE 3800972039896

SUBMERSIBLE SCREW PUMP FOR CLEAN WATER

RD-WP75

• [BG] Помпа водна дълбочинна винтова за чиста вода
• [RO] Pompa submersibila cu snec

 20 m	2700 l/h
H max 136 m	 1"
1200 W	230 V
S max 30 m	



ART.NO. 070201
BARCODE 3800972039902

DEEP WELL SUBMERSIBLE PUMP FOR CLEAN WATER

RD-3WP91

• [BG] Помпа водна дълбочинна за чиста вода • [RO] Pompa submersibila



ART.NO. BARCODE
070203 3800972044890

DEEP WELL SUBMERSIBLE PUMP FOR CLEAN WATER

RD-3WP92

• [BG] Помпа водна дълбочинна за чиста вода
• [RO] Pompa submersibila



ART.NO. BARCODE
070204 3800972044906

DEEP WELL SUBMERSIBLE PUMP FOR CLEAN WATER

RD-3WP93

• [BG] Помпа водна дълбочинна за чиста вода • [RO] Pompa submersibila



ART.NO. BARCODE
070205 3800972044913

DEEP WELL SUBMERSIBLE PUMP FOR CLEAN WATER

RD-WP41

• [BG] Помпа водна дълбочинна за чиста вода • [RO] Pompa submersibila



ART.NO. BARCODE
070148 3800123174711

DEEP WELL SUBMERSIBLE PUMP FOR CLEAN WATER

RD-WP69

• [BG] Помпа водна дълбочинна за чиста вода • [RO] Pompa submersibila

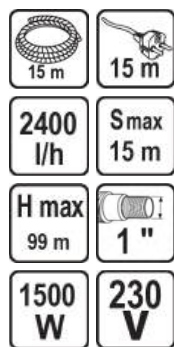

ART.NO. BARCODE
070176 3800972030329

DEEP WELL SUBMERSIBLE PUMP FOR CLEAN WATER

RD-WP31

• [BG] Помпа водна дълбочинна за чиста вода • [RO] Pompa submersibila





ART.NO. BARCODE
070138 3800123166716

DEEP WELL SUBMERSIBLE PUMP FOR CLEAN WATER

RD-WP70

• [BG] Помпа водна дълбочинна за чиста вода • [RO] Pompa submersibila

 15 m	 15 m
6840 l/h	Smax 15 m
H max 56 m	 1"
550 W	230 V



ART.NO. 070177
BARCODE 3800972030336

DEEP WELL SUBMERSIBLE PUMP FOR CLEAN WATER

RD-WP71

• [BG] Помпа водна дълбочинна за чиста вода • [RO] Pompa submersibila

 15 m	 15 m
Smax 15 m	H max 73 m
 1"	750 W
230 V	5400 l/h





ART.NO. 070178
BARCODE 3800972030343

DEEP WELL SUBMERSIBLE PUMP FOR CLEAN WATER

RD-WP24

• [BG] Помпа водна дълбочинна за чиста вода • [RO] Pompa submersibila

 20 m	 22 m
4800 l/h	Smax 20 m
H max 86 m	 1.5"
1100 W	230 V



ART.NO. 070131
BARCODE 3800123164590

DEEP WELL SUBMERSIBLE PUMP FOR CLEAN WATER

RD-WP92

• [BG] Помпа водна дълбочинна за чиста вода • [RO] Pompa submersibila

180 L/min	 22 m
H max 163m	 1.1/4"
3000 W	





ART.NO. 070206
BARCODE 3800972044920

DEEP WELL SUBMERSIBLE PUMP FOR CLEAN WATER

RD-WP93

• [BG] Помпа водна дълбочинна за чиста вода • [RO] Pompa submersibila

240 L/min	 22 m
H max 210m	 1.1/4"
5500 W	





ART.NO. 070207
BARCODE 3800972044937

FOUNTAIN PUMP

RD-WP35

• [BG] Помпа водна фонтан
• [RO] Pompa fantana arteziana

 10 m	1200 l/h
Smax 3 m	H max 1.6 m
28 W	 1/2"





ART.NO. 070142
BARCODE 3800123174582

FOUNTAIN PUMP

RD-WP21

- [BG] Помпа водна фонтан
- [RO] Pompa fantana arteziana

 2 m	1980 l/h
Smax 2.5 m	H max 3 m
50 W	 1"





ART.NO. 070124
BARCODE 3800123161452

FOUNTAIN PUMP

RD-WP36

- [BG] Помпа водна фонтан
- [RO] Pompa fantana arteziana

 10 m	2580 l/h
Smax 3 m	H max 2.6 m
75 W	 1"





ART.NO. 070143
BARCODE 3800123174599

BOOSTER PUMP WITH PRESSURE TANK

RD-WP550

- [BG] Хидрофор мини
- [RO] Hidrofor mini

2700 l/h	H max 58 m
3 bar	 1"
550 W	 3/4"



ART.NO. 071110
BARCODE 3800972032651

BOOSTER PUMP WITH PRESSURE TANK

RD-WP800Z

- [BG] Хидрофор
- [RO] Hidrofor

 1.5 m	3180 l/h
H max 40 m	3 bar
 1"	800 W



ART.NO. 071109
BARCODE 3800972029132

BOOSTER PUMP WITH PRESSURE TANK

RDP-WP800SW

- [BG] Хидрофор
- [RO] Hidrofor

 1.5 m	40 m H max
 800 W	 L 20
3 bar	 1"





ART.NO. 071105
BARCODE 3800972015777

BOOSTER PUMP WITH PRESSURE TANK

RD-WP1200J

- [BG] Хидрофор
- [RO] Hidrofor

 2 m	3840 l/h
Smax 7 m	H max 48 m
3 bar	 1"
1200 W	 L 20





ART.NO. 071104
BARCODE 3800123158360

BOOSTER PUMP WITH PRESSURE TANK

RD-WP1200S

• [BG] Хидрофор • [RO] Hidrofor

 1.5 m	3840 l/h
S max 7 m	H max 48 m
3 bar	 1"
1200 W	 1





ART.NO. 071107
 BARCODE 3800972017986

BOOSTER PUMP WITH PRESSURE TANK

RD-WP1300S

• [BG] Хидрофор • [RO] Hidrofor

 1.5 m	4800 l/h
S max 8 m	H max 48 m
3 bar	 1"
1300 W	 1



ART.NO. 071108
 BARCODE 3800972017993

SUCTION HOSE

RD

• [BG] Маркуч смукателен • [RO] Furtun de aspiratie



ART.NO. 071111
 BARCODE 3800972039100

SUCTION HOSE

RD

• [BG] Маркуч смукателен • [RO] Furtun de aspiratie





ART.NO. 071112
 BARCODE 3800972039117

SUBMERSIBLE PRESSURE PUMP AUTOMATIC

RD-WP66

• [BG] Помпа потопяема автоматична • [RO] Pompa cu plutitor

 15 m	 1 mm
6000 l/h	DP max 12 m
H max 40 m	 1"
1200 W	230 V





ART.NO. 070173
 BARCODE 3800972030299

ELECTRONIC BOOSTER PUMP

RD-WP17

• [BG] Помпа с електронен пресостат • [RO] Pompa cu presostat

 1.5 m	3840 l/h
S max 7 m	H max 48 m
4.8 bar	 1"
1200 W	 1



ART.NO. 070119
 BARCODE 3800123158353

SELF-PRIMING PUMP

RDP-WP45

• [BG] Помпа водна • [RO] Pompa cu autoamorsare

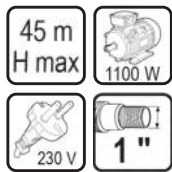

ART.NO. 070153
BARCODE 3800972015791

SELF-PRIMING PUMP

RDP-WP80

• [BG] Помпа водна • [RO] Pompa cu autoamorsare



ART.NO. 070180
BARCODE 3800972032118

CONTROL BOX FOR DEEP WELL SUBMERSIBLE PUMP

RD

• [BG] Пусково табло за сондажни помпи
• [RO] Panou de comanda pentru pompa de adancime



ART.NO. 070196
BARCODE 3800972038103

CONTROL BOX FOR DEEP WELL SUBMERSIBLE PUMP

RD

• [BG] Пусково табло за сондажни помпи
• [RO] Panou de comanda pentru pompa de adancime



ART.NO. 070191
BARCODE 3800972034617

CONTROL BOX FOR DEEP WELL SUBMERSIBLE PUMP

RD

• [BG] Пусково табло за сондажни помпи
• [RO] Panou de comanda pentru pompa de adancime

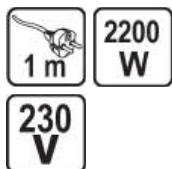

ART.NO. 070197
BARCODE 3800972038110

AUTOMATIC PUMP CONTROL

RD-EPC05

• [BG] Пресостат електронен • [RO] Presostat electronic



ART.NO. 070192
BARCODE 3800972037847

AUTOMATIC PUMP CONTROL

RD-EPC06

• [BG] Пресостат електронен • [RO] Presostat electronic

1/4" 1500 W



ART.NO. 070193
BARCODE 3800972038073

AUTOMATIC PUMP CONTROL

RD-EPC02

• [BG] Пресостат електронен • [RO] Presostat electronic

10 bar 1" 2200 W



ART.NO. 070127
BARCODE 3800123161483

AUTOMATIC PUMP CONTROL

RD-EPC03

• [BG] Пресостат електронен • [RO] Presostat electronic

2.5 bar 2200 W 1"



ART.NO. 070189
BARCODE 3800972033429

AUTOMATIC PUMP CONTROL

RD-EPC08

• [BG] Пресостат електронен • [RO] Presostat electronic

10 bar 1" 2200 W



ART.NO. 070195
BARCODE 3800972038097

AUTOMATIC PUMP CONTROL

RD-EPC04

• [BG] Пресостат електронен • [RO] Presostat electronic

15 bar 1" 2200 W



ART.NO. 070190
BARCODE 3800972033436

AUTOMATIC PUMP CONTROL

RD-EPC07

• [BG] Пресостат електронен • [RO] Presostat electronic

1/4" 2200 W



ART.NO. 070194
BARCODE 3800972038080

GASOLINE WATER PUMP

RD-GWP02J

• [BG] Помпа водна бензинова • [RO] Motorpompa motor benzina

 1"	 0.6 L	 25.4 cm³
7980 l/h	1.25 kW	
H max 17.5 m	6500 min ⁻¹	
S max 8 m	 0.7 L	







ART.NO. 079908
BARCODE 3800123158407

GASOLINE WATER PUMP

RD-GWP03J

• [BG] Помпа водна бензинова • [RO] Motorpompa motor benzina

 1.5"	 0.6 L	 42.7 cm³
15000 l/h	1.25 kW	
H max 35 m	6500 min ⁻¹	
S max 8 m	 1.5 L	



ART.NO. 092101
BARCODE 3800123161315

GASOLINE WATER PUMP

RD-GWP01

• [BG] Помпа водна бензинова • [RO] Motorpompa motor benzina

 2"	 0.6 L	 196 cm³
33000 l/h	4.1 kW	
H max 26 m	3600 min ⁻¹	
S max 8 m	 3.8 L	



ART.NO. 079906
BARCODE 3800123112980

GASOLINE WATER PUMP

RD-GWP04

• [BG] Помпа водна бензинова • [RO] Motorpompa motor benzina

 3"	 0.6 L	 196 cm³
933 l/h	4.83 kW	
H max 30 m	3600 min ⁻¹	
S max 8 m	 3.8 L	



ART.NO. 070149
BARCODE 3800972003569

HIGH PRESSURE CLEANER

RD-HPC09

• [BG] Водоструйка • [RO] Aparat de spalat cu presiune

5 l/min	100 bar
1400 W	230 V



ART.NO. 072109
BARCODE 3800972029286

HIGH PRESSURE CLEANER

RD-HPC17

• [BG] Водоструйка
• [RO] Aparat de spalat cu presiune

230V~ 50Hz	1600 W
P max 12 MPa	5.5 l/min
 5 m	



ART.NO. 072117
BARCODE 3800972046085

HIGH PRESSURE CLEANER

RD-HPC12

- [BG] Водоструйка
- [RO] Aparat de spalat cu presiune

7 l/min	150 bar
1800 W	230 V



ART.NO.	BARCODE
072112	3800972034624

SURFACE CLEANER

RD-HPC12

- [BG] Приставка за водоструйка
- [RO] Perie suprafete cu doua duze rotative pentru



ART.NO.	BARCODE
138125	3800972034730

HIGH PRESSURE CLEANER

RD-HPC11

- [BG] Водоструйка
- [RO] Aparat de spalat cu presiune

230V~ 50Hz	1800 W
P _{max} 14 MPa	6.0 l/min



ART.NO.	BARCODE
072111	3800972033276

HIGH PRESSURE CLEANER

RDP-HPC16

- [BG] Водоструйка
- [RO] Aparat de spalat cu presiune

230V~ 50Hz	2000 W
P _{max} 15 MPa	6.6 l/min
11,8 kg	



ART.NO.	BARCODE
072116	3800972046078

HIGH PRESSURE CLEANER

RDP-HPC15

- [BG] Водоструйка безчеткова
- [RO] Aparat de spalat cu presiune

230V~ 50Hz	2200 W
P _{max} 17 MPa	6.6 l/min
19 kg	



ART.NO.	BARCODE
072115	3800972046061

HIGH PRESSURE CLEANER

RDP-HPC14

- [BG] Водоструйка безчеткова
- [RO] Aparat de spalat cu presiune

7.8 l/min	195 bar
2500 W	230 V



ART.NO.	BARCODE
072114	3800972035874

HOSE FOR HIGH PRESSURE CLEANER

FOR RDP-HPC14

- [BG] Маркуч за водоструйка • [RO] Furtun pt aparat de spalat cu presiune

200
bar



ART.NO.	BARCODE
138126	3800972035935

GUN & LANCE SET FOR HIGH PRESSURE CLEANER

FOR RDP-HPC14

- [BG] Пистолет с метална тръба к-т за водоструйка
- [RO] Gun & Lance Set for High Pressure Cleaner



ART.NO.	BARCODE
138127	3800972035942

DETERGENT TANK FOR HIGH PRESSURE CLEANER

FOR RDP-HPC14

- [BG] Контейнер за препарат за водоструйка
- [RO] Rezervor detergent pt aparat de spalat cu presiune



ART.NO.	BARCODE
138128	3800972035959

QUICK RELEASE NOZZLES

FOR RDP-HPC14 15 16

- [BG] Комплект дюзи бърза връзка
- [RO] 0° 15° 25° 40° 60° pentru RDP-HPC14



ART.NO.	BARCODE
138129	3800972035966

GUN FOR HIGH PRESSURE CLEANER

FOR RDP-HPC15 16

- [BG] Пистолет за водоструйка
- [RO] Pistol pentru aparat de spalat cu presiune



ART.NO.	BARCODE
072118	3800972046092

GUN FOR HIGH PRESSURE CLEANER

FOR RD-HPC17 09

- [BG] Пистолет за водоструйка
- [RO] Pistol pentru aparat de spalat cu presiune



ART.NO.	BARCODE
072119	3800972046108

HOSE FOR HIGH PRESSURE CLEANER

FOR RDP-HPC15 16

• [BG] Маркуч за водоструйка • [RO] Furtun pentru aparat de spalat cu presiune

5
m

Ø
14-2

M22



ART.NO.	BARCODE
072120	3800972046115

HOSE FOR HIGH PRESSURE CLEANER

FOR RD-HPC17

• [BG] Маркуч за водоструйка • [RO] Furtun pentru aparat de spalat cu presiune

5
m

Ø
9



ART.NO.	BARCODE
072121	3800972046122

HOSE FOR HIGH PRESSURE CLEANER

FOR RD-HPC09

• [BG] Маркуч за водоструйка • [RO] Furtun pentru aparat de spalat cu presiune

5
m

Ø
9

Ø
14



ART.NO.	BARCODE
072122	3800972046139

DETERGENT TANK

FOR RDP-HPC15 16

• [BG] Контейнер за препарат за водоструйка • [RO] Recipient det.

470
ml



ART.NO.	BARCODE
072123	3800972046146

DETERGENT TANK

FOR RD-HPC17 09

• [BG] Контейнер за препарат за водоструйка • [RO] Recipient det.

370
ml



ART.NO.	BARCODE
072124	3800972046153

GASOLINE HIGH PRESSURE CLEANER

RD-GHPC13

• [BG] Водоструйка бензинова
• [RO] Aparat de spalat cu presiune pe benzina

7.5
l/min

140
bar

4800
W



ART.NO.	BARCODE
072113	3800972035515

GASOLINE HIGH PRESSURE CLEANER

RD-GHPC06

- [BG] Водоструйка бензинова
- [RO] Aparat de spalat cu presiune pe benзина



ART.NO. 072104
BARCODE 3800972010673

HOSE

FOR RD-GHPC06

- [BG] Маркуч за водоструйка
- [RO] Furtun pt aparat de spalat cu presiune



ART.NO. 138122
BARCODE 3800972019300

GUN

FOR RD-GHPC06

- [BG] Пистолет за водоструйка
- [RO] Pistol pentru



ART.NO. 138123
BARCODE 3800972019317

AIR COMPRESSOR

RD-AC05

- [BG] Компресор • [RO] Compresor de aer



ART.NO. 089402
BARCODE 3800123174537

AIR COMPRESSOR

RD-AC13

- [BG] Компресор • [RO] Compresor de aer



ART.NO. 089408
BARCODE 3800972016392

AIR COMPRESSOR

RD-AC14

- [BG] Компресор • [RO] Compresor de aer



ART.NO. 089409
BARCODE 3800972016408

AIR COMPRESSOR

RD-AC040

• [BG] Компресор • [RO] Compresor de aer



ART.NO. 089401
BARCODE 3800123173462

AIR COMPRESSOR

RDP-AC15

• [BG] Компресор • [RO] Compresor de aer



ART.NO. 089415
BARCODE 3800972028463

AIR COMPRESSOR

RD-AC12

• [BG] Компресор • [RO] Compresor de aer



ART.NO. 089407
BARCODE 3800972016071

AIR COMPRESSOR QUIET OIL FREE

RD-AC23

• [BG] Компресор тих безмаслен • [RO] Compresor de aer



**ИДВА СКОРО
COMING SOON**

ART.NO. 089421
BARCODE 3800972045781

AIR COMPRESSOR QUIET OIL FREE

RD-AC07

• [BG] Компресор тих безмаслен • [RO] Compresor de aer



ART.NO. 089405
BARCODE 3800972009639

AIR COMPRESSOR QUIET OIL FREE

RD-2AC21

• [BG] Компресор тих безмаслен • [RO] Compresor de aer



**ИДВА СКОРО
COMING SOON**

ART.NO. 089419
BARCODE 3800972045767

AIR COMPRESSOR QUIET OIL FREE

RD-2AC22

• [BG] Компресор тих безмаслен • [RO] Compresor de aer



**ИДВА СКОРО
COMING SOON**

ART.NO. BARCODE
089420 3800972045774

AIR COMPRESSOR QUIET OIL FREE

RD-3AC24

• [BG] Компресор тих безмаслен • [RO] Compresor de aer



**ИДВА СКОРО
COMING SOON**

ART.NO. BARCODE
089422 3800972045798

AIR COMPRESSOR

RD-AC02

• [BG] Компресор • [RO] Compresor de aer



ART.NO. BARCODE
120105 3800123123368

AIR COMPRESSOR

RDP-AC16

• [BG] Компресор • [RO] Compresor de aer



ART.NO. BARCODE
089416 3800972028470

AIR COMPRESSOR

RD-VAC26

• [BG] Компресор • [RO] Compresor de aer



**ИДВА СКОРО
COMING SOON**

ART.NO. BARCODE
089423 3800972045811

AIR COMPRESSOR

RD-AC08

• [BG] Компресор • [RO] Compresor de aer

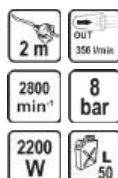

ART.NO. BARCODE
089406 3800972009646

AIR COMPRESSOR

RD-AC030

• [BG] Компресор • [RO] Compresor de aer

IN 370 l/min	2 m
OUT 310 l/min	2800 min ⁻¹
8 bar	2200 W
230 V	L 100



ART.NO.	BARCODE
120107	3800123160820

AIR COMPRESSOR

RD-AC17

• [BG] Компресор • [RO] Compresor de aer

OUT 170 l/min	1050 min ⁻¹
8 bar	1500 W
230 V	L 100



ART.NO.	BARCODE
120117	3800972030060

AIR COMPRESSOR

RD-AC18

• [BG] Компресор • [RO] Compresor de aer

OUT 320 l/min	1050 min ⁻¹
8 bar	1800 W
230 V	L 100



ART.NO.	BARCODE
120118	3800972030077

AIR COMPRESSOR

RD-AC25

• [BG] Компресор • [RO] Compresor de aer

OUT 320 l/min	2200 W	L 200
------------------	--------	-------

**ИДВА СКОРО
COMING SOON**

ART.NO.	BARCODE
120122	3800972045804

AIR COMPRESSOR

RD-AC19

• [BG] Компресор • [RO] Compresor de aer

OUT 250 l/min	1050 min ⁻¹
8 bar	2200 W
230 V	L 200



ART.NO.	BARCODE
120119	3800972030084

AIR COMPRESSOR

RD-AC06

• [BG] Компресор • [RO] Compresor de aer

OUT 900 l/min	2850 min ⁻¹
10 bar	7500 W
380 V	L 270



ART.NO.	BARCODE
089404	3800123174735

AIR DRILL

RD-AD02

• [BG] Бормашина пневматична • [RO] Masina gaurit pneumatica



ART.NO.	BARCODE
080103	3800123123689

AIR ANGLE GRINDER

RD-AA603

• [BG] Ъглошлайф пневматичен • [RO] Polizor unghiular pneumatic



ART.NO.	BARCODE
089939	3800123153648

CUTTING DISC FOR METAL FOR AIR ANGLE GRINDER

RD

• [BG] Диск за метал за пневматичен ъглошлайф • [RO] Disc pentru taiat metal



ART.NO.	BARCODE	SIZE
169904	3800123143731	Ø100x1x16 mm
169902	3800123141928	Ø100x3x16 mm
169903	3800123141935	Ø100x6x16 mm

AIR CUT OFF TOOL WITH DISC

RD-AC11

• [BG] Резачка пневматична • [RO] Masina de taiat pneumatica



ART.NO.	BARCODE
089921	3800123122415

CUTTING DISC FOR METAL FOR AIR CUT OFF TOOL

RD

• [BG] Диск за метал за пневматична резачка • [RO] Disc pentru taiat metal 7



ART.NO.	BARCODE	SIZE
169901	3800123122514	Ø75x1.6x10 mm

AIR RANDOM ORBITAL SANDER

RD-AROS01

• [BG] Ексцентършлиф пневматичен • [RO] Slefuitor pneumatic orbital



ART.NO. BARCODE
089301 3800123165375

AIR HAMMER MINI

RD-AH01

• [BG] Секач пневматичен • [RO] Dalta pneumatica



ART.NO. BARCODE
080102 3800123123672

AIR MICRO GRINDER

RD-AMG01

• [BG] Шлифовалка пневматична • [RO] Polizor drept pneumatic



ART.NO. BARCODE
089920 3800123122675

AIR DIE GRINDER

RD-ADG01

• [BG] Шлифовалка пневматична • [RO] Polizor drept pneumatic



ART.NO. BARCODE
081102 3800123123696

AIR ANGLE DIE GRINDER

RD-AADG06

• [BG] Шлифовалка пневматична • [RO] Polizor drept pneumatic



ART.NO. BARCODE
089924 3800123122446

AIR RATCHET

RD-AR01

• [BG] Тресчотка пневматична • [RO] Cheie cu clichet pneumatica



ART.NO. BARCODE
089905 3800123123702

AIR IMPACT WRENCH

RD-AW03

• [BG] Гайковерт пневматичен ударен • [RO] Cheie cu impact pneumatica



ART.NO. 089922
BARCODE 3800123122422

AIR IMPACT WRENCH

RD-AW04

• [BG] Гайковерт пневматичен ударен • [RO] Cheie cu impact pneumatica



ART.NO. 089940
BARCODE 3800123153655

COMBI AIR STAPLER&NAILER

RD-AS04

• [BG] Такер пневматичен скоби • [RO] Capsator pneumatic capse



ART.NO. 088102
BARCODE 3800972009141

STAPLES 5000 PCS.

RD-AS04

• [BG] Скоби за пневматичен такер • [RO] Capsator pneumatic capse

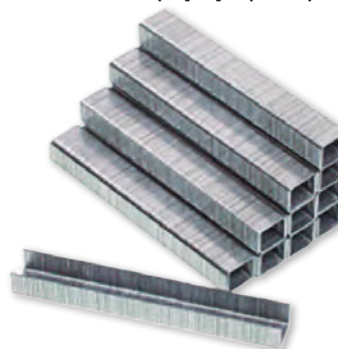

ART.NO.	BARCODE	SIZE
511407	3800972010338	10x10x1.2 mm
511408	3800972010345	12x10x1.2 mm
511409	3800972010352	14x10x1.2 mm
511410	3800972010369	16x10x1.2 mm
511411	3800972010376	20x10x1.2 mm

AIR STAPLER

RD-AS01

• [BG] Такер пневматичен • [RO] Capsator pneumatic capse



ART.NO. 089908
BARCODE 3800123123146

STAPLES 5000 PCS.

RD-AS01

• [BG] Скоби за пневматичен такер • [RO] Set de capse



ART.NO.	BARCODE	SIZE
511300	3800123104831	6x9.1x0.7 mm
511308	3800123122248	8x9.1x0.7 mm
511309	3800123122255	10x9.1x0.7 mm
511310	3800123122262	12x9.1x0.7 mm
511311	3800123122279	14x9.1x0.7 mm
511312	3800123122286	16x9.1x0.7 mm

AIR STAPLER

RD-AS03

• [BG] Такер пневматичен • [RO] Capsator pneumatic capse



ART.NO.	BARCODE
088101	3800972002326

STAPLES 10 000 PCS.

RD-AS03

• [BG] Скоби за пневматичен такер • [RO] Set de capse



ART.NO.	BARCODE	SIZE
511401	3800972002340	6x9.1x0.7 mm
511402	3800972002357	8x9.1x0.7 mm
511403	3800972002364	10x9.1x0.7 mm
511404	3800972002371	12x9.1x0.7 mm
511405	3800972002388	14x9.1x0.7 mm
511406	3800972002395	16x9.1x0.7 mm

AIR STAPLER

RD-AS02

• [BG] Такер пневматичен • [RO] Capsator pneumatic capse

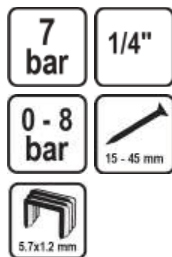

ART.NO.	BARCODE
089923	3800123122439

STAPLES 5000 PCS.

RD-AS02

• [BG] Скоби за пневматичен такер • [RO] Set de capse

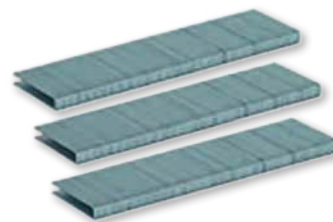

ART.NO.	BARCODE	SIZE
511330	3800123139710	16x5.7x1.2 mm
511317	3800123122521	25x5.7x1.2 mm
511318	3800123122538	32x5.7x1.2 mm
511350	3800123171574	40x5.7x1.2 mm

NAILS 5000 PCS.

RD-AS02

• [BG] Пирони за пневматичен такер • [RO] Set 5000 de cuie ti

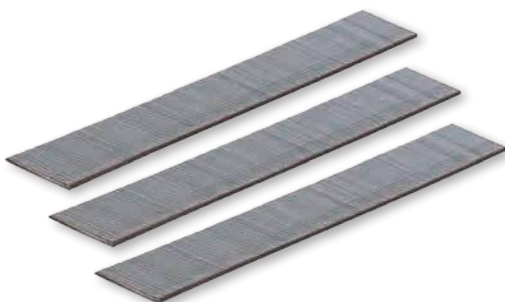

ART.NO.	BARCODE	SIZE
511313	3800123122293	15x1 mm
511314	3800123122309	25x1 mm
511315	3800123122316	35x1 mm
511316	3800123122323	45x1 mm

SANDBLASTING GUN

RD-SBG01

• [BG] Пистолет пясъкоструен • [RO] Pistol pentru sablat



ART.NO. BARCODE
089942 3800123165382

ALUMINUM OXIDE SILICONE CARBIDE SAND FOR SANDBLASTING

RD

• [BG] Пясък абразивен • [RO] Nisip pt. sablat 0



ART.NO. BARCODE
160151 3800123166655

AIR DUSTER GUN

RD-DG02

• [BG] Пистолет за въздух • [RO] Pistol pt suflat

1/4"



ART.NO. BARCODE
089802 3800123159282

AIR DUSTER GUN

RD-DG03

• [BG] Пистолет за въздух
• [RO] Pistol pt suflat

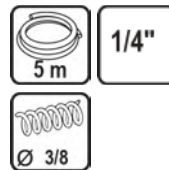

ART.NO. BARCODE
089803 3800972022843

AIR CLEANING GUN

RD-CG01

• [BG] Пистолет за почистване • [RO] Pistol cu tija si rezervor



ART.NO. BARCODE
089916 3800123122408

PISTOL-GRIP AIR INFLATOR WITH GAUGE

RD-TI01

• [BG] Пистолет за гуми с манометър • [RO] Manometru

1/4"



ART.NO. BARCODE
089904 3800123137075

PLUG FOR HOSE OF INFLATING GUN

RD

• [BG] Накрайник за помпване на гуми за маркуч • [RO] Mufa pistol aer



ART.NO. BARCODE
110906 3800123159435

AIR BRUSH 7 PCS.

RD-AB02

• [BG] Аерограф 7 части • [RO] Aerograf



ART.NO. BARCODE
089936 3800123153389

AIR BRUSH 8 PCS.

RD-AB01

• [BG] Аерограф 8 части • [RO] Aerograf



ART.NO. BARCODE
089935 3800123153372

AIR SPRAY GUN FOR POLYURETHANE INSULATION

RD-PUSG13

• [BG] Пистолет за полиуретан
• [RO] Pistol pneumatic pt izolatie poliuretanic

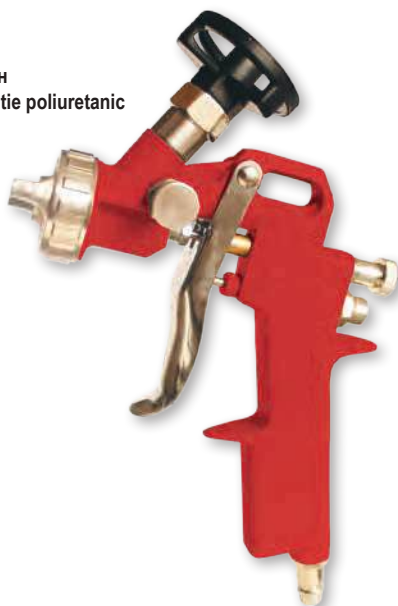

ART.NO. BARCODE
089944 3800972010215

SPRAY GUN GRAVITY

RD-SG02

• [BG] Пистолет за боя с горно казанче
• [RO] Pistol de vopsit



ART.NO. BARCODE
089909 3800123123177

SPRAY GUN GRAVITY

RD-SG05

- [BG] Пистолет за боя с горно казанче
- [RO] Pistol de vopsit



ART.NO.	BARCODE
089934	3800123152238

PLASTIC CUP

RD-SG05

- [BG] Казанче • [RO] Rezervor plastic



ART.NO.	BARCODE
110912	3800123173073

NOZZLE, NEEDLE & AIR CAP SET

RD-SG05

- [BG] Дюза, игла и капачка
- [RO] Set duza reparatie



ART.NO.	BARCODE	SIZE
110909	3800123173042	Ø1.2 mm
110908	3800123165405	Ø1.4 mm
110910	3800123173059	Ø1.8 mm
110911	3800123173066	Ø2.0 mm

SPRAY GUN GRAVITY

RD-SG04

- [BG] Пистолет за боя с горно казанче
- [RO] Pistol de vopsit

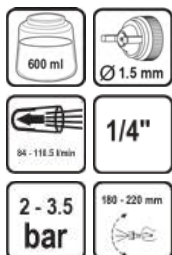

ART.NO.	BARCODE
089933	3800123152221

NOZZLE, NEEDLE & AIR CAP SET

RD-SG04

- [BG] Дюза, игла и капачка • [RO] Set duza reparatie



ART.NO.	BARCODE
110907	3800123165399

SPRAY GUN GRAVITY LATERALLY

RD-SG03

- [BG] Пистолет за боя с горно странично казанче
- [RO] Pistol de vopsit



ART.NO.	BARCODE
089910	3800123123184

SPRAY GUN GRAVITY LATERALLY

RD-SG12

- [BG] Пистолет за боя с горно странично казанче
- [RO] Pistol de vopsit



ART.NO.	BARCODE
089943	3800972003507

SPRAY GUN SUCTION

RD-SG01

- [BG] Пистолет за боя с долно казанче
- [RO] Pistol de vopsit



ART.NO. BARCODE
089903 3800123122132



SPRAY GUN TANK

RD-PT01

- [BG] Пистолет за боя казанче • [RO] Pistol de vopsit cu rezervor



ART.NO. BARCODE
089914 3800123122163

SPRAY GUN TANK

RD-PT02

- [BG] Пистолет за боя казанче • [RO] Pistol de vopsit cu rezervor



ART.NO. BARCODE
089915 3800123122156

AIR TOOLS 5PCS. KIT SPRAY GUN SUCTION

RD-AT01

- [BG] Пистолети за боя с горно казанче и за въздух 5бр. к-т
- [RO] Accesorii compresor set 5pcs



ART.NO. BARCODE
089902 3800123122149

AIR TOOLS 5PCS. KIT SPRAY GUN GRAVITY

RD-AT02

- [BG] Пистолети за боя с горно казанче и за въздух 5бр. к-т
- [RO] Accesorii compresor set 5pcs



ART.NO. BARCODE
089913 3800123122231

COMBINED REGULATOR, AIR FILTER, WATER TRAP & LUBRICATOR

RD-AF02

• [BG] Пневмоподготвяща група за пневматична система • [RO] Filtru aer regulator & lubricator

0.05-1.0 MPa  1/4"



ART.NO. BARCODE
089918 3800123122170

LUBRICATOR

RD-A001

• [BG] Омаслител за пневматична система • [RO] Mini dispozitiv de uns

0.05-1.0 MPa  1/4"



ART.NO. BARCODE
089938 3800123153402

AIR FILTER & WATER TRAP

RD-AF01

• [BG] Влагуловител за пневматична система • [RO] Mini filtru

0.05-1.0 MPa  1/4" M&F



ART.NO. BARCODE
089917 3800123122002

AIR REGULATOR 1

RD

• [BG] Редущир вентил с манометър • [RO] Regulator aer cu ceas

0 - 1 MPa  1/4" F



ART.NO. BARCODE
110601 3800123159299

MANOMETER

RD

• [BG] Манометър • [RO] Manometru

0 - 1.2 MPa  1/4"



ART.NO. BARCODE
110602 3800123159305

AIR QUICK COUPLER

RD

• [BG] Накрайник пневм. бърза връзка • [RO] Conector rapid

ART.NO.	BARCODE	SIZES	INFO	PICTURE
089937	3800123153396	1/2"	MALE THREAD	
089927	3800123122477	1/4"	MALE THREAD	
089925	3800123122453	1/4"	FEMALE THREAD	
089930	3800123122507	1/4"	Ø6 mm	
110901	3800123159381	1/4"	Ø8 mm	
110902	3800123159398	1/4"	Ø10 mm	
089926	3800123122460	1/4"	FEMALE THREAD	
089928	3800123122484	1/4"	MALE THREAD	
089929	3800123122491	1/4"	Ø6 mm	
110903	3800123159404	1/4"	Ø8 mm	
110904	3800123159411	1/4"	Ø10 mm	
089912	3800123123269	1/4"	5 PCS SET	
110804	3800123159374	1/4" F	Y-TYPE CONNECTOR	
110805	3800123159343	BPH 1/2" M TO 3/8" F	CONICAL REDUCTION	
110803	3800123159367	BPH 3/8" M TO 1/4" F	CONICAL REDUCTION	

AIR PU SPIRAL HOSE

RD-CH03

• [BG] Маркуч • [RO] Furtun spiralat aer comprimat

0.83 MPa	P _{max} 2.4 MPa	 1/4"
PU	M&F	



ART.NO.	BARCODE	SIZE (Ø)	LENGHT	FOR MODEL
110701	3800123159312	Ø6.5x9.5 mm	5 m	RD-CH03
139904	3800123123429	Ø6.5x9.5 mm	10 m	RD-CH01
110702	3800123159329	Ø8x12 mm	15 m	RD
110703	3800123159336	Ø10x14 mm	15 m	RD

AIR PU SPIRAL HOSE

RD-CH02

• [BG] Маркуч • [RO] Furtun spiralat aer comprimat

P 2.07 MPa	P _{max} 8.2 MPa	 1/4"
 20 m	PU	



ART.NO.	BARCODE	SIZE (Ø)	LENGHT	FOR MODEL
089919	3800123122033	Ø6.5x10 mm	20 m	RD-CH02

AIR PU HOSE WITH QUICK COUPLINGS

RD-CH04

• [BG] Маркуч • [RO] Furtun spiralat aer comprimat

P 2.07 MPa	PU	 1/4"
 30 m		



ART.NO.	BARCODE	SIZE (Ø)	LENGHT	FOR MODEL
089945	3800972049369	Ø10x14 mm	30 m	RD-CH04

COUNTERSINKS FOR METAL 4 PCS. SET

RD

• [BG] Зенкери за метал 4 бр. • [RO] Set 4 freze conice pentru metal



ART.NO.	BARCODE	SIZE
157119	3800972045194	Ø2-5, 5-10, 10-15, 15-20 mm

HSS COMBINATION TAP 6 PCS SET

RD

• [BG] Комплект комбинирани метчици • [RO] Set 6 tarozi pentru filetat



ART.NO.	BARCODE	SIZE
162134	3800972045170	FROM M2 TO M6

DRILL BITS 6 PCS. HSS-R SET

RD

• [BG] Свредла за метал 6 бр. • [RO] Set 6 burghie



ART.NO.	BARCODE	SIZE
157110	3800123168482	Ø2, 3, 4, 5, 6, 8 mm

DRILL BIT 6 PCS.

RD

• [BG] Свредла за метал HSS-Co 6бр. • [RO] Set 6 burghie

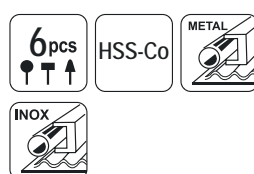

ART.NO.	BARCODE	SIZE
157112	3800123168673	Ø2 3 4 5 6 8 mm

DRILL BITS 10 PCS. HSS-R SET

RD

• [BG] Свредла за метал 10 бр. • [RO] Set 10 burghie



ART.NO.	BARCODE	SIZE
157111	3800123168499	Ø1-10 mm

DRILL BITS 13 PCS. HSS SET

RD

• [BG] Свредла за метал 13 бр. • [RO] Set 13 burghie



ART.NO.	BARCODE	SIZE
150681	3800972023482	Ø1.5-6.5 mm

DRILL BITS HSS+TIN 13 PCS. SET

RD

• [BG] Свредла за метал 13 бр. • [RO] Set 13 burghie



ART.NO.	BARCODE	SIZE
150683	3800972023505	Ø2-8 mm

DRILL BITS HSS+TIN 15 PCS. SET

RD

• [BG] Свредла за метал 15 бр. HSS+TIN
• [RO] Set 15 burghie pentru metal HSS TIN



ART.NO.	BARCODE	SIZE
157789	3800123169540	Ø1.5-10 mm

DRILL BITS HSS&MASONRY DRILL BITS 17 PCS.

RD

• [BG] Свредла за метал и бетон 17 бр. к-т
• [RO] Set 17 burghie pentru metal si zidarie



ART.NO.	BARCODE	SIZE
157796	3800123169618	Ø1.5-10 mm

DRILL BITS 19 PCS. HSS SET

RD

• [BG] Свредла за метал 19 бр • [RO] Set 19 burghie



ART.NO.	BARCODE	SIZE
150682	3800972023499	Ø1-10 mm

DRILL BITS HSS+TIN 19 PCS. SET

RD

• [BG] Свредла за метал 19 бр • [RO] Set 19 burghie



ART.NO.	BARCODE	SIZE
150684	3800972023512	Ø1-10 mm

DRILL BITS HSS (TIN COATED) 99 PCS. SET

RD

• [BG] Свредла HSS+TIN 99 бр. к-т • [RO] Set 99 burghie pentru metal HSS TIN



ART.NO.	BARCODE	SIZE
150697	3800972044524	Ø1.5-10 mm

DRILL BITS, SCREW BITS, HOLE SAWS SET OF 246 PCS. SET

RD

- [BG] Свредла битове боркорони 246 бр. комплект
- [RO] Set 246 burghie, carote si biti

246 pcs
↑ ↑ ↑



ART.NO.	BARCODE
150696	3800972044517

STEP DRILL BIT HEX SHANK

RD

- [BG] Свредло стъпаловидно HEX
- [RO] Burghiu conic in trepte HEX

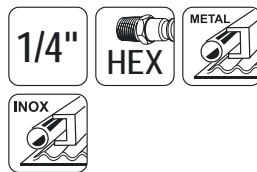

ART.NO.	BARCODE	HEX	SIZE
150700	3800972048225	1/4"	Ø3-12 mm
150678	3800972004986	1/4"	Ø4-12 mm
150679	3800972004993	1/4"	Ø4-20 mm
150680	3800972005006	1/4"	Ø6-30 mm
150701	3800972048232	1/4"	Ø4-32 mm
150702	3800972048249	1/4"	Ø4-40 mm
150703	3800972048256	1/4"	Ø4-45 mm
150704	3800972048263	1/4"	Ø4-52 mm
150705	3800972048270	1/4"	Ø6-60 mm

STEP DRILL BITS HEX SHANK HSS+TIN SPIRAL FLUTE 3 PCS.

RD

- [BG] Свредла стъпаловидни HEX 1/4" HSS+TIN spiral flute Set
- [RO] Set burghie pentru metal si zidarie



ART.NO.	BARCODE	SIZE
150685	3800972029187	Ø4-12, 4-20, 4-32 mm

STEP DRILL BITS 3 SAWTOOTH SLOTTED DRILL 6 PCS.

RD

- [BG] Свредла стъпаловидни к-т 6 бр. • [RO] Set 6 burghie conice in trepte



ART.NO.	BARCODE	SIZE
150706	3800972048287	Ø3, 6, 8 mm

STEP DRILL BITS 3 SAWTOOTH SLOTTED DRILL 7 PCS. SET

RD

- [BG] Свредла стъпаловидни к-т 7 бр • [RO] Set 7 burghie conice in trepte

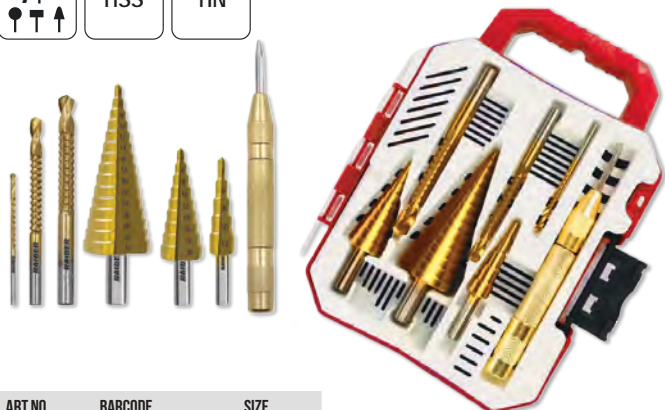

ART.NO.	BARCODE	SIZE
150707	3800972048294	Ø3, 6, 8 mm

SAWTOOTH SLOTTED DRILL HSS (TIN COATED)

RD

- [BG] Свредло-Фрезер HSS+TIN • [RO] Burghiu tip freza combinata HSS TiN



ART.NO.	BARCODE	SIZE
150686	3800972044418	Ø3.0 mm
150687	3800972044425	Ø4.0 mm
150688	3800972044432	Ø5.0 mm
150689	3800972044449	Ø6.0 mm
150690	3800972044456	Ø6.5 mm
150691	3800972044463	Ø8.0 mm

SAWTOOTH SLOTTED DRILL HSS (TIN COATED)

RD

• [BG] Свредло-Фрезер HSS+TIN • [RO] Burghiu tip freza combinata HSS TiN



ART.NO.	BARCODE	SIZE
150692	3800972044470	Ø6.0 mm - 1/4 HEX
150693	3800972044487	Ø8.0 mm - 1/4 HEX

SAWTOOTH SLOTTED DRILL HSS (TIN COATED) 6 PCS. SET

RD

• [BG] Свредло-Фрезер HSS+TIN 6 бр. • [RO] Set 6 burghie tip freza combinata HSS TiN



ART.NO.	BARCODE	SIZE
150694	3800972044494	Ø3-8 mm

SAWTOOTH SLOTTED DRILL HSS (TIN COATED) 5 PCS. SET

RD

• [BG] Свредло-Фрезер HSS+TIN 5 бр. • [RO] Set 5 burghie tip freza combinata HSS TiN



ART.NO.	BARCODE	SIZE
150695	3800972044500	Ø3-8 mm 1/4 HEX

DRILL BIT HSS-CO

RD

• [BG] Свредло за метал HSS-Co • [RO] Burghiu HSS-Co

ART.NO.	BARCODE	SIZE (mm)	QTY
150698	3800972048201	Ø1.0 mm	2 PCS.
150699	3800972048218	Ø1.5 mm	2 PCS.
157695	3800123168680	Ø2.0 mm	2 PCS.
157696	3800123168697	Ø2.5 mm	2 PCS.
157697	3800123168703	Ø3.0 mm	2 PCS.
157698	3800123168710	Ø3.2 mm	2 PCS.
157699	3800123168727	Ø3.5 mm	2 PCS.
157700	3800123168734	Ø4.0 mm	2 PCS.
157715	3800123168741	Ø4.2 mm	1 PCS.
157716	3800123168758	Ø4.5 mm	1 PCS.
157717	3800123168765	Ø5.0 mm	1 PCS.
157718	3800123168772	Ø6.0 mm	1 PCS.
157719	3800123168789	Ø6.5 mm	1 PCS.
157720	3800123168796	Ø7.0 mm	1 PCS.
157721	3800123168802	Ø8.0 mm	1 PCS.
157722	3800123168819	Ø10.0 mm	1 PCS.
157723	3800123168826	Ø12.0 mm	1 PCS.



DRILL BIT HSS-R

RD

• [BG] Свредло за метал HSS-R • [RO] Burghiu HSS-R

ART.NO.	BARCODE	SIZE (mm)	QTY (PCS)
157678	3800123168505	Ø1.0 mm	2 PCS.
157679	3800123168512	Ø1.5 mm	2 PCS.
157680	3800123168529	Ø2.0 mm	2 PCS.
157681	3800123168536	Ø2.5 mm	2 PCS.
157682	3800123168543	Ø3.0 mm	2 PCS.
157683	3800123168550	Ø3.2 mm	2 PCS.
157684	3800123168567	Ø3.5 mm	2 PCS.
157685	3800123168574	Ø4.0 mm	2 PCS.
157686	3800123168581	Ø4.2 mm	1 PCS.
157687	3800123168598	Ø4.5 mm	1 PCS.
157950	3800972048430	Ø4.8 mm	1 PCS.
157688	3800123168604	Ø5.0 mm	1 PCS.
157689	3800123168611	Ø6.0 mm	1 PCS.
157690	3800123168628	Ø6.5 mm	1 PCS.
157691	3800123168635	Ø7.0 mm	1 PCS.
157692	3800123168642	Ø8.0 mm	1 PCS.
157693	3800123168659	Ø10.0 mm	1 PCS.
157694	3800123168666	Ø12.0 mm	1 PCS.



DRILL BIT HSS+TIN

RD

• [BG] Свредло за метал HSS+TIN • [RO] Burghiu HSS+TIN

ART.NO.	BARCODE	SIZE (mm)	QTY
150655	3800123164262	Ø1.0 mm	2 PCS.
150656	3800123164279	Ø1.5 mm	2 PCS.
150657	3800123164286	Ø2.0 mm	2 PCS.
150658	3800123164293	Ø2.5 mm	2 PCS.
150659	3800123164309	Ø3.0 mm	2 PCS.
150660	3800123164316	Ø3.2 mm	2 PCS.
150661	3800123164323	Ø3.5 mm	2 PCS.
150662	3800123164330	Ø4.0 mm	2 PCS.
150663	3800123164347	Ø4.2 mm	1 PCS.
150664	3800123164354	Ø4.5 mm	1 PCS.
150665	3800123164361	Ø4.8 mm	1 PCS.
150666	3800123164378	Ø5.0 mm	1 PCS.
150667	3800123164385	Ø5.5 mm	1 PCS.
150668	3800123164392	Ø6.0 mm	1 PCS.
150669	3800123164408	Ø6.5 mm	1 PCS.
150670	3800123164415	Ø7.0 mm	1 PCS.

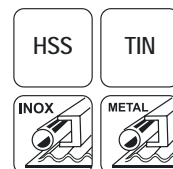

150951	3800972048447	Ø7.5 mm	1 PCS.
150671	3800123164422	Ø8.0 mm	1 PCS.
150672	3800123164439	Ø8.5 mm	1 PCS.
150673	3800123164446	Ø9.0 mm	1 PCS.
150674	3800123164453	Ø10.0 mm	1 PCS.
150675	3800123164460	Ø11.0 mm	1 PCS.
150676	3800123164477	Ø12.0 mm	1 PCS.
150677	3800123164484	Ø13.0 mm	1 PCS.

MASONRY DRILL BITS 5 PCS. SET

RD

• [BG] Свредла за бетон 5 бр. • [RO] Set burghie pt. zidarie 5 pcs.

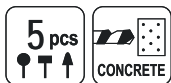

ART.NO.	BARCODE	SIZE
157113	3800123168833	Ø4, 5, 6, 8, 10 mm

MASONRY DRILL BITS 15 PCS. SET

RD

• [BG] Свредла за бетон 15 бр. • [RO] Set burghie pt. zidarie 15 pcs.

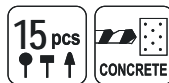

ART.NO.	BARCODE	SIZE
157790	3800123169557	Ø 3-10 mm

MASONRY DRILL BIT

RD

• [BG] Свредло за бетон • [RO] Burghiu zidarie



ART.NO.	BARCODE	SIZE (mm)
157724	3800123168840	Ø3 (30x70 mm)
157725	3800123168857	Ø4 (40x75 mm)
157726	3800123168864	Ø5 (50x85 mm)
157727	3800123168871	Ø6 (60x100 mm)
157729	3800123168895	Ø8 (80x120 mm)
157730	3800123168901	Ø10 (90x150 mm)

AUGER BITS FOR WOOD 5 PCS. SET

RD

• [BG] Свредла за дърво Auger 5 бр. • [RO] Set 5 burghie pt.lemn

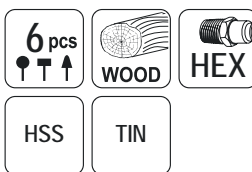

ART.NO.	BARCODE	SIZE
157799	3800972029194	Ø10, 13, 19, 22, 25 mm

AUGER DRILL BIT FOR WOOD HEX SHANK

RD

• [BG] Свредло за дърво Auger • [RO] Burghiu spiralat pentru lemn

ART.NO.	BARCODE	SIZE	ART.NO.	BARCODE	SIZE
157951	3800972050167	Ø8x230 mm	157967	3800972050327	Ø20x460 mm
157952	3800972050174	Ø10x230 mm	157975	3800972050402	Ø20x600 mm
157953	3800972050181	Ø12x230 mm	157958	3800972050235	Ø22x230 mm
157963	3800972050280	Ø12x460 mm	157968	3800972050334	Ø22x460 mm
157954	3800972050198	Ø14x230 mm	157976	3800972050419	Ø22x600 mm
157964	3800972050297	Ø14x460 mm	157959	3800972050242	Ø24x230 mm
157972	3800972050372	Ø14x600 mm	157969	3800972050341	Ø24x460 mm
157955	3800972050204	Ø16x230 mm	157977	3800972050426	Ø24x600 mm
157965	3800972050303	Ø16x460 mm	157960	3800972050259	Ø26x230 mm
157973	3800972050389	Ø16x600 mm	157970	3800972050358	Ø26x460 mm
157956	3800972050211	Ø18x230 mm	157978	3800972050433	Ø26x600 mm
157966	3800972050310	Ø18x460 mm	157961	3800972050266	Ø30x230 mm
157974	3800972050396	Ø18x600 mm	157962	3800972050273	Ø32x230 mm
157957	3800972050228	Ø20x230 mm	157971	3800972050365	Ø32x460 mm
			157979	3800972050440	Ø32x600 mm



FOUR FLUTE AUGER DRILL BIT FOR WOOD HEX SHANK

RD

- [BG] Свредло за дърво 4 Cut проходно HEX
- [RO] Burghiu elicoidal pentru lemn cu 4 placii HEX



ART.NO.	BARCODE	SIZE
157980	3800972050457	Ø10 mm
157981	3800972050464	Ø12 mm
157982	3800972050471	Ø14 mm
157983	3800972050488	Ø16 mm
157984	3800972050495	Ø18 mm
157985	3800972050501	Ø20 mm
157986	3800972050518	Ø22 mm
157987	3800972050525	Ø25 mm
157988	3800972050532	Ø28 mm
157989	3800972050549	Ø30 mm

TCT DRILL BIT FOR FAST WOOD DRILLING HEX SHANK

RD

- [BG] Свредло за дърво TCT проходно HEX
- [RO] Burghiu pentru lemn cu varf carbura HEX



ART.NO.	BARCODE	SIZE
157511	3800972050730	Ø16 mm
157512	3800972050747	Ø18 mm
157513	3800972050754	Ø20 mm
157514	3800972050761	Ø22 mm
157515	3800972050778	Ø25 mm

REAMER FOR WOOD HEX SHANK

RD

- [BG] Свредло за дърво за райбероване • [RO] Burghiu pt. lemn 3 Cut HEX



ART.NO.	BARCODE	SIZE
157990	3800972050556	Ø10 mm
157991	3800972050563	Ø12 mm
157992	3800972050570	Ø14 mm
157993	3800972050587	Ø16 mm
157994	3800972050594	Ø18 mm
157995	3800972050600	Ø20 mm
157996	3800972050617	Ø22 mm
157997	3800972050624	Ø25 mm
157998	3800972050631	Ø28 mm
157999	3800972050648	Ø30 mm

COUNTERSINK DRILL BITS TIN FOR WOOD 5 PCS. SET

RD

- [BG] Свредла TIN с фрезенк за дърво 1/4" hex 5 бр. • [RO] Set 5 burghie lemn

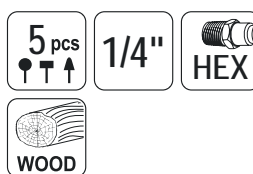

ART.NO.	BARCODE	SIZE
157116	3800972039025	Ø5, 6, 8, 10, 12 mm

COUNTERSINKS WOOD 3 PCS. SET

RD

- [BG] Зенкери за дърво 3 бр. • [RO] Set 3 burghie lemn



ART.NO.	BARCODE	SIZE
157118	3800972045187	Ø12, 16, 19 mm

COUNTERSINKS TIN WOOD 6 PCS. SET

RD

- [BG] Фрезенк за дърво HEX 6 бр. • [RO] Set 6 burghie lemn



ART.NO.	BARCODE	SIZE
150708	3800972048300	Ø6, 8, 9, 12, 16, 19 mm

WOODWORKING CHAMFER DRILLING TOOL SET 26 PCS. SET

RD

- [BG] Свредла + стъпаловидни + фрезери за дърво 26 бр. к-т
- [RO] Set 26 freze profilate pentru lemn

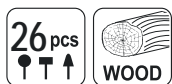

ART.NO.	BARCODE
150709	3800972048317

BRAD POINT DRILL BITS FOR WOOD 5 PCS. SET

RD

- [BG] Свредла за дърво 5 бр. • [RO] Set 5 burghie lemn



ART.NO.	BARCODE	SIZE
157114	3800123168918	04, 5, 6, 8, 10 mm

BRAD POINT DRILL BITS FOR WOOD 15 PCS. SET

RD

- [BG] Свредла за дърво 15 бр. • [RO] Set 15 burghie pentru

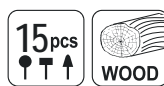

ART.NO.	BARCODE	SIZE
157791	3800123169564	03-10 mm

BRAD POINT DRILL BITS FOR WOOD

RD

- [BG] Свредло за дърво • [RO] Burghiu pentru lemn



ART.NO.	BARCODE	SIZE (mm)	QTY
157731	3800123168925	03	2 PCS.
157732	3800123168932	04	2 PCS.
157733	3800123168949	05	1 PCS.
157734	3800123168956	06	1 PCS.
157736	3800123168970	08	1 PCS.
157737	3800123168987	010	1 PCS.
157738	3800123168994	012	1 PCS.

FLAT SPEED SPADE BITS FOR WOOD 7 PCS. SET

RD

- [BG] Свредла за дърво плоски HEX 7 бр.
- [RO] Set 7 burghie pentru lemn plate

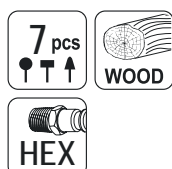

ART.NO.	BARCODE	SIZE
157794	3800123169595	010, 12, 16, 19, 22, 25, 32 mm

FLAT SPEED SPADE BIT FOR WOOD 1/4" HEX SHANK

**FOR EFFICIENT
WOOD DRILLING**

Multiple sizes available

- [BG] Свредло за дърво плоско
- [RO] Burghiu pt. lemn plat coada HEX

ART.NO.	BARCODE	HEX	SIZE (mm)
157739	3800123169014	1/4"	Ø14 mm
157740	3800123169021	1/4"	Ø16 mm
157940	3800972044531	1/4"	Ø18 mm
157741	3800123169038	1/4"	Ø20 mm
157742	3800123169045	1/4"	Ø22 mm
157941	3800972044548	1/4"	Ø24 mm
157743	3800123169052	1/4"	Ø25 mm
157744	3800123169069	1/4"	Ø28 mm
157745	3800123169076	1/4"	Ø30 mm
157942	3800972044555	1/4"	Ø32 mm
157943	3800972044562	1/4"	Ø35 mm
157944	3800972044579	1/4"	Ø36 mm
157945	3800972044586	1/4"	Ø38 mm
157946	3800972044593	1/4"	Ø40 mm
157947	3800972044609	1/4"	Ø45 mm
157948	3800972044616	1/4"	Ø50 mm
157949	3800972044623	1/4"	Ø55 mm



GLASS AND TILE DRILL BIT

RD

- [BG] Свредло за стъкло и керамика
- [RO] Burghiu pentru sticla si ceramica

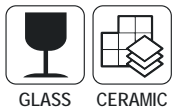

GLASS

CERAMIC



ART.NO.	BARCODE	SIZE (mm)
157763	3800123169267	Ø3
157764	3800123169274	Ø4
157765	3800123169281	Ø5
157766	3800123169298	Ø6
157767	3800123169304	Ø8
157768	3800123169311	Ø10
157769	3800123169328	Ø12

GLASS AND TILE DRILL BITS 3 PCS. SET

RD

- [BG] Свредла за стъкло 3 бр.
- [RO] Burghie pentru sticla si ceramica set 3 buc



GLASS

CERAMIC



ART.NO.	BARCODE	SIZE
157115	3800123169250	Ø5, 6, 8 mm

GLASS AND TILE DRILL BITS 5 PCS. SET

RD

- [BG] Свредла за стъкло 5 бр.
- [RO] Set 5 burghie pentru sticla si ceramica



GLASS

CERAMIC



ART.NO.	BARCODE	SIZE
157798	3800123169632	Ø3, 4, 6, 8, 10 mm

DRILL BIT 4CUT HEX 1/4"

- [BG] Свредло MultiMat® 4Cut Hex
- [RO] Burghiu multi-material

MultiMat®

ART.NO.	BARCODE	HEX	SIZE
159921	3800972041738	1/4"	Ø3x92 mm
159922	3800972041745	1/4"	Ø4x92 mm
159923	3800972041752	1/4"	Ø5x97 mm
159924	3800972041769	1/4"	Ø6x100 mm

159928	3800972041776	1/4"	Ø7x100 mm
159925	3800972041783	1/4"	Ø8x116 mm
159926	3800972041790	1/4"	Ø10x118 mm
159927	3800972041806	1/4"	Ø12x118 mm



DRILL BITS 4CUT HEX 5 PCS. SET

- [BG] Свредло MultiMat® 4Cut Hex 5 бр. к-кт
- [RO] Set 5 burghie multi-material 4 placi

ART.NO.	BARCODE	SIZE
159920	3800972041721	Ø4, 5, 6, 8, 10 mm



RAIDER®

DRILL BIT 2CUT

- [BG] Свредло MultiMat® 2Cut
- [RO] Burghiu multi-material

MultiMat®

ART.NO.	BARCODE	SIZE
159930	3800972042025	Ø3x80 mm
159931	3800972042032	Ø4x80 mm
159932	3800972042049	Ø5x80 mm
159933	3800972042056	Ø6x100 mm
159934	3800972042063	Ø7x100 mm
159935	3800972042070	Ø8x112 mm
159936	3800972042087	Ø10x116 mm
159937	3800972042094	Ø12x118 mm



DRILL BITS 2CUT 5 PCS. SET

- [BG] Свредло MultiMat® 2Cut 5 бр.
- [RO] Set 5 burghie multi-material 2 plac

ART.NO.	BARCODE	SIZE
159929	3800972042018	Ø4, 5, 6, 8, 10 mm

RAIDER®

DRILL BIT ASYMMETRICAL

- [BG] Свредло MultiMat® Asymmetrical
- [RO] Burghiu multimaterial asimetric

MultiMat®

ART.NO.	BARCODE	SIZE
159948	3800972043992	Ø3x60 mm
159949	3800972044005	Ø4x80 mm
159950	3800972044012	Ø5x90 mm
159951	3800972044029	Ø6x90 mm
159952	3800972044036	Ø8x90 mm
159953	3800972044043	Ø10x90 mm
159954	3800972044050	Ø12x110 mm



DRILL BITS ASYMMETRICAL 5 PCS. SET

- [BG] Свредло MultiMat® Asymmetrical
- [RO] Set 5 burghie multimaterial asimetric

ART.NO.	BARCODE	SIZE
159947	3800972043985	Ø4, 6, 8, 10, 12 mm



DRILL BIT 4CUT

TIN HEX

MultiMat®

- [BG] Свредло MultiMat® 4Cut TIN Hex
- [RO] Burghiu multi-material 4 placi

ART.NO.	BARCODE	HEX	SIZE
159939	3800972042117	1/4"	Ø3x92 mm
159940	3800972042124	1/4"	Ø4x92 mm
159941	3800972042131	1/4"	Ø5x97 mm
159942	3800972042148	1/4"	Ø6x100 mm
159944	3800972042162	1/4"	Ø8x116 mm
159945	3800972042179	1/4"	Ø10x118 mm
159946	3800972042186	1/4"	Ø12x118 mm



DRILL BITS 4CUT TIN HEX 1/4"

5 PCS. SET

- [BG] Свредло MultiMat® 4Cut TIN HEX
- [RO] Set 5 burghie multi-material 4 placi

ART.NO.	BARCODE	SIZE
159938	3800972042100	Ø4, 5, 6, 8, 10 mm

CHISELS SDS-PLUS 2 PCS. POINT & FLAT SET

RD

• [BG] Длета SDS-plus 2 бр. шило и секач к-т • [RO] Dalti SDS-plus 2 pcs set



ART.NO.	BARCODE
154022	3800972050129

CHISELS SDS-PLUS 3 PCS. FLAT & HOLLOW GOUGING SET

RD

• [BG] Длета SDS-plus 2 бр. секач и лопатка к-т • [RO] Dalti SDS-plus 2 pcs set



ART.NO.	BARCODE
154023	3800972050136

CHISELS SDS-PLUS 4 PCS. POINT FLAT TILE & HOLLOW GOUGING SET

RD

• [BG] Длета SDS-plus 4 бр. шило секач лопатка каналокопател к-т
• [RO] Dalti SDS-plus 4 pcs set



ART.NO.	BARCODE
154024	3800972050143

CHISELS SDS-PLUS 3 PCS. SET

RD

• [BG] Длета SDS-plus 3 бр. к-т • [RO] Dalti SDS-Plus 3 pcs. set



ART.NO.	BARCODE
159904	3800123125263



HAMMER DRILL BITS & CHISELS WITH SDS-PLUS, SDS-MAX AND HEX SHANK

- [BG] Свредла и консумативи със SDS-plus, SDS-max и HEX (шестостенен) захват
- [RO] Burghie și dălți pentru ciocane perforatoare cu SDS-plus, SDS-max și tijă hexagonală



ART.NO.	BARCODE	NAME	SIZES	TYPE	PICTURE
154001	3800123125645	HOLLOW GOUGING CHISEL	14x250 mm	SDS-PLUS	
154002	3800123125676	HOLLOW GOUGING CHISEL	17x250 mm	SDS-PLUS	
154007	3800123159985	TILE CHISEL	14x250 mm	SDS-PLUS	
154008	3800972002524	TILE CHISEL	14x250x40 mm x10°	SDS-PLUS	
154015	3800972026926	FLAT CHISEL SELF-SHARPENING	22x14x250 mm	SDS-PLUS S	
154003	3800123125638	FLAT CHISEL	14x250 mm	SDS-PLUS	
154004	3800123125669	FLAT CHISEL	17x250 mm	SDS-PLUS	
154017	3800972050075	FLAT CHISEL	40x250x14 mm	SDS-PLUS	
154018	3800972050082	FLAT CHISEL	75x280x17 mm	SDS-PLUS	
154019	3800972050099	FLAT CHISEL	120x280x17 mm	SDS-PLUS	
154020	3800972050105	FLAT CHISEL SDS-PLUS POINTED TUNGSTEN CARBIDE TIP	10x150 mm	SDS-PLUS	
154021	3800972050112	FLAT CHISEL SDS-PLUS TUNGSTEN CARBIDE FLAT TIP	14x250 mm	SDS-PLUS	
154016	3800972029095	POINT CHISEL SDS-PLUS SELF-SHARPENING	14x250 mm	SDS-PLUS	
154005	3800123125621	POINT CHISEL	14x250 mm	SDS-PLUS	
154006	3800123125652	POINT CHISEL	17x250 mm	SDS-PLUS	
154203	3800123145025	POINT CHISEL	18x400 mm	SDS-MAX	
154205	3800972009028	POINT CHISEL	18x600 mm	SDS-MAX	
154202	3800123145032	FLAT CHISEL	18x400 mm	SDS-MAX	
154204	3800972009011	FLAT CHISEL	18x600 mm	SDS-MAX	
154201	3800123145049	TILE CHISEL	18x300x50 mm	SDS-MAX	
154206	3800972016064	HOLLOW GOUGING CHISEL	18x25x320 mm	SDS-MAX	

HAMMER DRILL BIT SDS-MAX

RD

• [BG] Свредло SDS-max • [RO] Burghiu SDS-max

ART.NO.	BARCODE	SIZE
153802	3800123125942	Ø10x260 mm
153803	3800123125959	Ø12x260 mm
153804	3800123125966	Ø16x400 mm
153805	3800123125973	Ø20x400 mm
153806	3800123125980	Ø22x505 mm
153807	3800123125997	Ø25x600 mm
153801	3800123145018	Ø32x600 mm
153808	3800972010468	Ø12x400 mm
153809	3800972010475	Ø14x400 mm
153810	3800972010482	Ø16x600 mm
153811	3800972010499	Ø16x1000 mm
153812	3800972010505	Ø18x600 mm
153813	3800972010512	Ø18x1000 mm
153814	3800972010529	Ø20x600 mm
153815	3800972010536	Ø20x1000 mm
153816	3800972010543	Ø22x1000 mm
153817	3800972010550	Ø25x1000 mm
153818	3800972010567	Ø30x600 mm
153821	3800972031142	Ø35x600 mm
153819	3800972010574	Ø30x1000 mm
153820	3800972010581	Ø35x1000 mm



HAMMER DRILL BIT SDS-PLUS

RD

• [BG] Свредло SDS-plus • [RO] Burghiu SDS-plus

ART.NO.	BARCODE	SIZE
159910	3800123150159	Ø4x110 mm
153630	3800123160165	Ø5x110 mm
153629	3800123160158	Ø5x160 mm
153634	3800123160219	Ø5x210 mm
153631	3800123160172	Ø6x110 mm
153601	3800123125447	Ø6x160 mm
153602	3800123125454	Ø6x210 mm
153632	3800123160189	Ø8x110 mm
153616	3800123160028	Ø8x160 mm
153603	3800123125478	Ø8x210 mm
153604	3800123125461	Ø8x260 mm
153617	3800123160035	Ø8x350 mm
153652	3800123160615	Ø8x450 mm
153633	3800123160196	Ø10x110 mm
153605	3800123125485	Ø10x160 mm
153606	3800123125492	Ø10x210 mm
153618	3800123160042	Ø10x260 mm
153607	3800123125508	Ø10x310 mm
153619	3800123160059	Ø10x350 mm
153620	3800123160066	Ø10x460 mm
153621	3800123160073	Ø12x160 mm
153608	3800123125515	Ø12x210 mm
153609	3800123125522	Ø12x310 mm
153622	3800123160080	Ø12x350 mm
153623	3800123160097	Ø12x450 mm
153624	3800123160103	Ø14x160 mm
153635	3800123160226	Ø14x210 mm
153636	3800123160233	Ø14x260 mm
153653	3800123160622	Ø14x310 mm
153625	3800123160110	Ø14x350 mm
153610	3800123125539	Ø14x450 mm
153638	3800123160257	Ø16x160 mm
153639	3800123160264	Ø16x210 mm
153651	3800123160608	Ø16x300 mm
153626	3800123160127	Ø16x350 mm
153611	3800123125546	Ø16x450 mm
153640	3800123160271	Ø18x210 mm
153627	3800123160134	Ø18x350 mm
153612	3800123125553	Ø18x450 mm
153628	3800123160141	Ø20x350 mm
153613	3800123125560	Ø20x450 mm
153614	3800123125577	Ø22x450 mm
153646	3800123160332	Ø24x450 mm
153615	3800123125584	Ø26x450 mm
153647	3800123160349	Ø28x450 mm
153648	3800123160356	Ø30x450 mm
153649	3800123160363	Ø32x450 mm



HAMMER DRILL BIT SDS-PLUS

RD

• [BG] Свредло SDS-plus • [RO] Burghiu SDS-plus



ART.NO.	BARCODE	SIZE
153682	3800972010598	Ø14x1000 mm
153683	3800972010604	Ø18x1000 mm
153684	3800972010611	Ø22x1000 mm
153685	3800972010628	Ø30x1000 mm
153686	3800972010635	Ø32x1000 mm

HAMMER DRILL BITS SDS-PLUS 5 PCS. SET

RD

• [BG] Свредло SDS-plus 5 части к-т • [RO] Burghie SDS-plus 5pcs. set



ART.NO.	BARCODE	SIZE
158101	3800123125591	Ø5-10 mm



HAMMER DRILL BIT CROSS HEAD SDS-PLUS

RD

• [BG] Свредло Cross Head SDS-plus • [RO] Burghiu Cross Head SDS-plus

ART.NO.	BARCODE	SIZE
153656	3800123151255	06x110 mm
153657	3800123151262	06x160 mm
153658	3800123151279	06x210 mm
153659	3800123151286	06.5x260 mm
153660	3800123151293	08x110 mm
153661	3800123151309	08x160 mm
153662	3800123151316	08x210 mm
153663	3800123151323	08x260 mm
153664	3800123151330	08x350 mm
153665	3800123151347	010x160 mm
153666	3800123151354	010x210 mm
153667	3800123151361	010x260 mm
153668	3800123151378	010x350 mm
153669	3800123151385	010x450 mm
153670	3800123151392	012x210 mm
153671	3800123151408	012x350 mm
153672	3800123151415	012x450 mm
153673	3800123151422	014x160 mm
153674	3800123151439	014x210 mm
153675	3800123151446	014x260 mm
153676	3800123151453	014x350 mm
153677	3800123151460	014x450 mm
153678	3800972003156	016x260 mm
153679	3800972003163	018x260 mm
153680	3800972003170	020x260 mm
153681	3800972003187	024x260 mm



ADAPTOR FROM SDS-MAX TO SDS-PLUS

RD

• [BG] Адаптор SDS Max-SDS Plus • [RO] Adaptor de la SDS Max-SDS Plus



ART.NO.	BARCODE
159916	3800123141805

HOLESAW ARBOR SDS-PLUS

RD

• [BG] Водач SDS-plus за боркорона • [RO] Tija pilot carota pt.beton



ART.NO.	BARCODE	SIZE
154811	3800123102516	200 mm
154805	3800123122705	300 mm
157801	3800123162725	500 mm

CARBIDE CORE CUTTER SDS-PLUS

RD

• [BG] Боркорона за бетон с водач и свредло SDS plus
• [RO] Carota gaurire beton cu tija si burghiu



ART.NO.	BARCODE	SIZE
154812	3800972016729	030 mm
154813	3800972016736	035 mm
154818	3800972035980	040 mm
154814	3800972016743	045 mm
154819	3800972035997	050 mm
154815	3800972016750	065 mm
154824	3800972036215	068 mm
154820	3800972036000	080 mm
154816	3800972016767	085 mm
154821	3800972036017	0100 mm
154822	3800972036024	0110 mm
154823	3800972036031	0120 mm
154817	3800972016774	0130 mm



HOLESAW ARBOR SDS-MAX

RD

• [BG] Водач SDS-max за боркорона • [RO] Tija pilot carota pt.beton



ART.NO.	BARCODE	SIZE
157802	3800123163777	500 mm

CARBIDE CORE CUTTER SDS-PLUS 6 PCS. SET

RD

- [BG] Боркорони за бетон с водач и свредло 6 части к-т SDS plus
- [RO] Carota gaurire beton cu tija si burghiu 6



ART.NO.	BARCODE	SIZE
154870	3800972042711	Ø16-60 mm

CARBIDE CORE CUTTER SDS-PLUS 13 PCS. SET

RD

- [BG] Боркорони за бетон с водач и свредло 13 части к-т SDS Plus
- [RO] Carota gaurire beton cu tija si burghiu 13



ART.NO.	BARCODE	SIZE
154871	3800972042728	Ø19-75 mm

SHEET METAL HOLESAW 5 PCS. SET

RD

- [BG] Боркорона за ламарина 5 части к-т • [RO] Set 5 carote pentru tabla



ART.NO.	BARCODE	SIZE
154857	3800972042735	Ø16-30 mm

SHEET METAL HOLESAW 6 PCS. SET

RD

- [BG] Боркорона за ламарина 6 части к-т • [RO] Set 6 carote pentru tabla



ART.NO.	BARCODE	SIZE
154859	3800972042759	Ø16-30 mm

SHEET METAL HOLESAW 5 PCS. SET

RD

- [BG] Боркорона за ламарина 5 части к-т • [RO] Set 5 carote pentru tabla



ART.NO.	BARCODE	SIZE
154858	3800972042742	Ø20-40 mm

SHEET METAL HOLESAW 12 PCS. SET

RD

- [BG] Боркорона за ламарина 12 части к-т • [RO] Set 12 carote pentru tabla



ART.NO.	BARCODE	SIZE
154860	3800972042766	Ø16-50 mm

SHEET METAL HOLESAW

WITH PILOT HSS DRILL BIT

- [BG] Боркорона за ламарина с водач HSS
- [RO] Carota pentru tabla cu pilot HSS

ART. NO.	BARCODE	SIZE
154803	3800972042384	Ø14 mm
154825	3800972042391	Ø15 mm
154826	3800972042407	Ø16 mm
154827	3800972042414	Ø17 mm
154828	3800972042421	Ø18 mm
154829	3800972042438	Ø19 mm
154830	3800972042445	Ø20 mm
154831	3800972042452	Ø21 mm
154832	3800972042469	Ø22 mm
154833	3800972042476	Ø23 mm
154834	3800972042483	Ø24 mm
154801	3800123160424	Ø25 mm
154835	3800972042490	Ø26 mm
154836	3800972042506	Ø27 mm
154837	3800972042513	Ø28 mm
154838	3800972042520	Ø30 mm
154839	3800972042537	Ø32 mm
154802	3800123160431	Ø35 mm
154840	3800972042544	Ø38 mm
154841	3800972042551	Ø40 mm
154842	3800972042568	Ø42 mm
154843	3800972042575	Ø45 mm
154844	3800972042582	Ø48 mm
154845	3800972042599	Ø50 mm
154846	3800972042605	Ø53 mm
154847	3800972042612	Ø55 mm
154848	3800972042629	Ø60 mm
154849	3800972042636	Ø65 mm
154850	3800972042643	Ø70 mm
154851	3800972042650	Ø75 mm
154852	3800972042667	Ø80 mm
154853	3800972042674	Ø85 mm
154854	3800972042681	Ø90 mm
154855	3800972042698	Ø95 mm
154856	3800972042704	Ø100 mm

**HEX****HSS**

SUITABLE FOR CUTTING

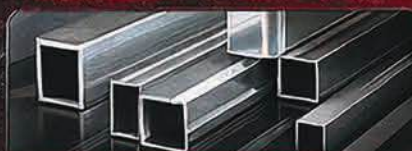
**CAST IRON****STAINLESS STEEL****ALUMINIUM ALLOY****NON-FERROUS METALS**

ADJUSTABLE HOLE CUTER

RD

• [BG] Боркорона за дърво • [RO] Freza lemn reglabila-pna la

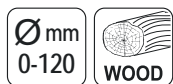

ART.NO.	BARCODE	SIZE
157703	3800123121579	Ø120 mm

HOLESAW AND DRILL BIT KIT

RD

• [BG] Боркорона и свредлоза дърво к-кт
• [RO] Set carota si burghiu pentru lemn

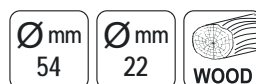

ART.NO.	BARCODE	SIZE
157701	3800123121180	Ø54 mm, Ø22 mm

HOLE CUTTERS 16 PCS. KIT

RD

• [BG] Боркорони 16 части к-т • [RO] 16Pcs/Set freza gaurire

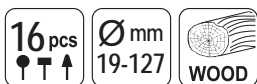

ART.NO.	BARCODE	SIZE
157710	3800123126000	Ø19 - 127 mm

HOLE CUTTERS 7 PCS. SET

RD

• [BG] Боркорони 7 части к-т • [RO] Set carote 7 piece



**ИДВА СКОРО
COMING SOON**

ART.NO.	BARCODE	SIZE
157705	3800972042810	Ø64 - 127 mm

HOLE CUTTERS 11 PCS. SET

RD

• [BG] Боркорони 11 части к-т • [RO] 11Pcs/Set freza gaurire

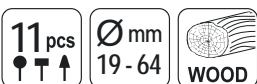

ART.NO.	BARCODE	SIZE
157707	3800123121203	Ø19 - 64 mm

HOLE CUTTERS 7 PCS. KIT

RD

• [BG] Боркорони 2" 7 части к-т • [RO] 7Pcs/Set freza gaurire

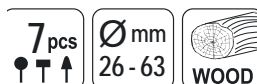

ART.NO.	BARCODE	SIZE
157704	3800123121197	Ø26 - 63 mm

BI-METAL HOLESAWS 9 PCS. KIT

RD

• [BG] Боркорони биметални 9 части к-кт • [RO] 9Pcs/Set freze gaurire

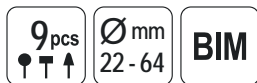

ART.NO.	BARCODE	SIZE
157712	3800123160011	Ø22 - 64 mm

HOLESAW FOR CERAMICS 7 PCS. SET

RD

• [BG] Боркорони за керамични плочки 7 ч. • [RO] Set carote pentru placi ceramice

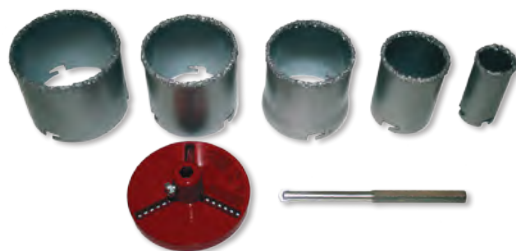
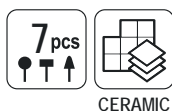

ART.NO.	BARCODE	SIZE
157714	3800123115783	Ø33 - 83 mm

ADJUSTABLE HOLE CUTTER

RD

• [BG] Свредло за плочки • [RO] Dispositiv taiere circulara

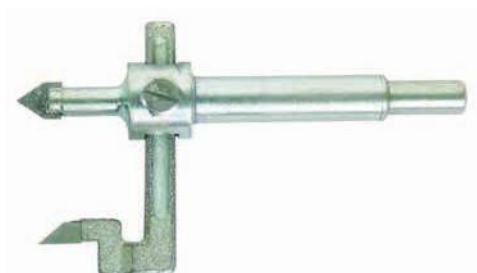
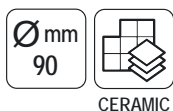

ART.NO.	BARCODE	SIZE
159908	3800123116490	Ø90 mm

HSS BI-METAL HOLESAW

• [BG] Боркорона HSS bi-metal • [RO] Carota HSS bimetal

ART. NO.	BARCODE	SIZE			
157911	3800972042827	Ø16 mm	157919	3800972042902	Ø50 mm
157912	3800972042834	Ø18 mm	157751	3800123169137	Ø51 mm
157746	3800123169083	Ø20 mm	157920	3800972042919	Ø53 mm
157786	3800123169496	Ø22 mm	157921	3800972042926	Ø55 mm
157747	3800123169090	Ø25 mm	157752	3800123169144	Ø57 mm
157913	3800972042841	Ø28 mm	157922	3800972042933	Ø60 mm
157787	3800123169502	Ø30 mm	157923	3800972042940	Ø61 mm
157748	3800123169106	Ø32 mm	157924	3800972042957	Ø63 mm
157749	3800123169113	Ø35 mm	157753	3800123169151	Ø65 mm
157914	3800972042858	Ø38 mm	157754	3800123169168	Ø68 mm
157788	3800123169519	Ø40 mm	157925	3800972042964	Ø71 mm
157915	3800972042865	Ø41 mm	157755	3800123169175	Ø76 mm
157916	3800972042872	Ø42 mm	157926	3800972042971	Ø81 mm
157750	3800123169120	Ø44 mm	157756	3800123169182	Ø83 mm
157917	3800972042889	Ø46 mm	157927	3800972042988	Ø89 mm
157918	3800972042896	Ø48 mm	157928	3800972042995	Ø114 mm



HSS BI-METAL HOLESAW 15 PCS. SET

RD

• [BG] К-кт Боркорони HSS bi-metal 15 части • [RO] Set 15 carote HSS bimetal

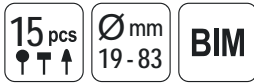

ART.NO.	BARCODE	SIZE
157930	3800972042803	Ø19-83 mm

HOLESAW ARBOR HEX SHANK FOR WITH Co PILOT DRILL BIT

RD

• [BG] Водач за би-метални боркорони с центриращо Co свредло
• [RO] Tija pilot carota pt. lemn



ART.NO.	BARCODE	SIZE
157800	3800123170065	Ø14-30 mm 1/2" (12.5 mm)



ART.NO.	BARCODE	SIZE
157757	3800123169199	Ø32-200 mm 5/8" (16 mm)

COBALT PILOT DRILL BIT FOR BI-METAL

RD

• [BG] Центриращо свредло за водач за би-метални боркорони • [RO] Suport cu burghiu cobalt pentru carote bi-material



ART.NO.	BARCODE	SIZE
157837	3800972002043	Ø6,35 mm L72 mm

HSS BI-METAL HOLESAW WITH Co PILOT DRILL BIT

RD

• [BG] Боркорона HSS bi-metal с центриращо свредло • [RO] Carota HSS bi-metal cu burghiu pilot

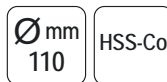

ART.NO.	BARCODE	SIZE
157929	3800972042797	Ø110 mm

HSS BI-METAL HOLESAW WITH PILOT DRILL BIT AND SHANK FOR DRILL DRIVER

RD

• [BG] Боркорона HSS bi-metal с центриращо свредло и опашка
• [RO] Carota HSS bimetal cu burghiu pilot

ART. NO.	BARCODE	SIZE
157811	3800972043008	Ø14 mm
157812	3800972043015	Ø15 mm
157813	3800972043022	Ø16 mm
157814	3800972043039	Ø17 mm
157815	3800972043046	Ø18 mm
157816	3800972043053	Ø19 mm
157817	3800972043060	Ø20 mm
157818	3800972043077	Ø21 mm
157819	3800972043084	Ø22 mm
157880	3800972043091	Ø23 mm
157881	3800972043107	Ø24 mm
157882	3800972043114	Ø25 mm
157883	3800972043121	Ø26 mm
157884	3800972043138	Ø28 mm
157885	3800972043145	Ø30 mm
157886	3800972043152	Ø32 mm
157887	3800972043169	Ø35 mm
157888	3800972043176	Ø38 mm
157889	3800972043183	Ø40 mm
157890	3800972043190	Ø42 mm
157891	3800972043206	Ø45 mm
157892	3800972043213	Ø48 mm
157893	3800972043220	Ø50 mm
157894	3800972043237	Ø53 mm
157895	3800972043244	Ø55 mm
157896	3800972043251	Ø60 mm
157901	3800972043268	Ø63 mm
157902	3800972043275	Ø65 mm
157903	3800972043282	Ø70 mm
157904	3800972043299	Ø75 mm
157905	3800972043305	Ø80 mm
157906	3800972043312	Ø85 mm
157907	3800972043329	Ø105 mm
157908	3800972043336	Ø110 mm
157909	3800972043343	Ø120 mm
157910	3800972043350	Ø130 mm



HOLESAW ARBOR HEX SHANK WITH PILOT DRILL BIT AND HOLESAW SET

RD

- [BG] Боркорона с водач и центриращо свредло к-т
- [RO] Ax HEX cu burghiu pilot + panza

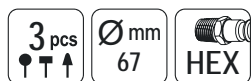

ART.NO.	BARCODE	SIZE
157761	3800972041707	Ø 67 mm

HOLESAW SET 6 PCS. SET

RD

- [BG] Боркорони 6 части к-т • [RO] Set carote 6 buc



ART.NO.	BARCODE	SIZE
157805	3800972041714	Ø32, 38, 44, 54 mm

HSS BI-METAL HOLESAW 8% Co

RD

- [BG] Боркорона HSS bi-metal • [RO] Carota bi-metal HSS 8% Co pentru metal si inox

ART. NO.	BARCODE	SIZE
157820	3800123173080	Ø20 mm
157821	3800123173097	Ø22 mm
157822	3800123173103	Ø25 mm
157823	3800123173110	Ø30 mm
157824	3800123173127	Ø32 mm
157825	3800123173134	Ø35 mm
157826	3800123173141	Ø40 mm
157827	3800123173158	Ø44 mm
157828	3800123173165	Ø51 mm
157829	3800123173172	Ø57 mm
157830	3800123173189	Ø65 mm
157831	3800123173196	Ø68 mm
157832	3800123173219	Ø76 mm
157833	3800123173226	Ø83 mm

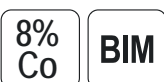

TUNGSTEN CARBIDE TIPPED HOLE SAW

RD

- [BG] Боркорона Carbide • [RO] Carota pentru zidarie si caramida

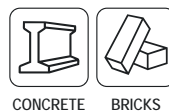

ART. NO.	BARCODE	SIZE
157758	3800123169205	Ø33 mm
157759	3800123169212	Ø43 mm
157770	3800123169335	Ø53 mm
157760	3800123169229	Ø67 mm
157771	3800123169342	Ø73 mm
157772	3800123169359	Ø83 mm
157773	3800123169366	Ø103 mm

HOLESAW ARBOR FOR TUNGSTEN CARBIDE TIPPED HOLE SAWS

RD

- [BG] Водач за Carbide боркорони • [RO] Suport carote carburi



ART.NO.	BARCODE	SIZE
157762	3800123169243	Ø33-103 mm

PILOT DRILL BIT FOR HOLESAW ARBOR FOR TUNGSTEN CARBIDE TIPPED HOLE SAWS

RD

- [BG] Центриращо свредло за водач за Carbide боркорони • [RO] Burghiu de centrare prindere HEX



ART.NO.	BARCODE	SIZE
157803	3800123173479	Ø10 mm

DIAMOND COATED HOLE SAW

- [BG] Боркорона Diamond
- [RO] Carota pentru placi ceramice dimantata

ART. NO.	BARCODE	SIZE			
157774	3800123169373	06 mm	157780	3800123169434	035mm (1 3/8")
157775	3800123169380	08 mm	158127	3800972049895	038 mm
157776	3800123169397	010 mm	158128	3800972049901	040 mm
157777	3800123169403	012 mm	157781	3800123169441	044 mm (1 3/4)
158117	3800972049796	06 mm 2 PCS	157782	3800123169458	051 mm (2")
158118	3800972049802	08 mm 2 PCS	158129	3800972049918	055 mm
158119	3800972049819	010 mm 2 PCS	158130	3800972049925	060 mm
158120	3800972049826	012 mm 2 PCS	158131	3800972049932	065 mm
158121	3800972049833	014 mm	157783	3800123169465	068 mm
158122	3800972049840	016 mm	158132	3800972049949	070 mm
158123	3800972049857	018 mm	157784	3800123169472	076 mm (3")
157785	3800972035973	020 mm	158133	3800972049956	077 mm
158124	3800972049864	022 mm	158134	3800972049963	080 mm
157778	3800123169410	025 mm (1")	158135	3800972049970	085 mm
158125	3800972049871	028 mm	158136	3800972049987	090 mm
157779	3800123169427	030 mm (1 1/8")	158137	3800972049994	0110 mm
158126	3800972049888	032 mm	158138	3800972050006	0105 mm
			158139	3800972050013	0115 mm



FOR FAIENCE AND CERAMIC

DIAMOND COATED HOLE SAW WITH PILOT DRILL BIT

RD

- [BG] Боркорона Diamond с центриращо свредло
- [RO] Carota pentru placi ceramice dimantata cu burghiu pilot



ART. NO.	BARCODE	SIZE
158102	3800972049604	Ø16 mm
158103	3800972049611	Ø20 mm
158104	3800972049628	Ø25 mm
158105	3800972049635	Ø30 mm
158106	3800972049642	Ø32 mm
158107	3800972049659	Ø35 mm
158108	3800972049666	Ø38 mm
158109	3800972049673	Ø40 mm
158110	3800972049680	Ø45 mm
158111	3800972049697	Ø51 mm
158112	3800972049703	Ø55 mm
158113	3800972049710	Ø65 mm
158114	3800972049727	Ø68 mm
158115	3800972049734	Ø100 mm
158116	3800972049741	Ø115 mm



DRILL GUIDE HOLDER FOR DIAMOND COATED HOLE SAWS

RD

- [BG] Водач за диамантени боркорони • [RO] Suport gaurire pentru carote diamantate

Ø mm
4-83



ART.NO.	BARCODE	SIZE
157711	3800972002401	Ø4-83 mm

DIAMOND HOLE SAW WITH SPRING

- [BG] Боркорона Diamond с пружина за бормашина
- [RO] Carota diamantata cu arc

ART. NO.	BARCODE	SIZE
189111	3800972043466	Ø20 mm
189112	3800972043473	Ø22 mm
189113	3800972043480	Ø25 mm
189114	3800972043497	Ø28 mm
189115	3800972043503	Ø30 mm
189116	3800972043510	Ø32 mm
189117	3800972043527	Ø35 mm
189118	3800972043534	Ø38 mm
189119	3800972043541	Ø40 mm
189120	3800972043558	Ø42 mm
189121	3800972043565	Ø45 mm
189122	3800972043572	Ø50 mm
189123	3800972043589	Ø55 mm
189124	3800972043596	Ø60 mm
189125	3800972043602	Ø65 mm



DIAMOND FOR HARD CERAMICS HOLE SAWS DRY

- [BG] Боркорона Diamond Dry за бормашина
- [RO] Carota diamantata pt ceramica dura taiere uscata

- ◆ Diamond for Hard Ceramics
- ◆ Dry Use for Drill Driver

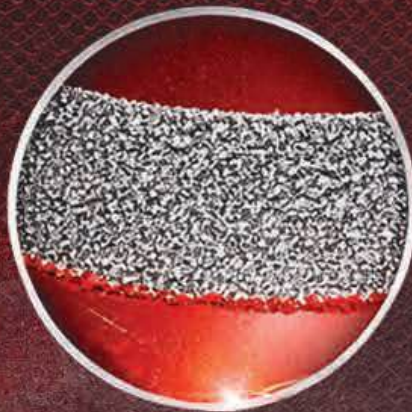

ART. NO.	BARCODE	SIZE
189126	3800972043718	Ø6 mm
189127	3800972043725	Ø8 mm
189128	3800972043732	Ø10 mm
189129	3800972043749	Ø12 mm
189130	3800972043756	Ø14 mm
189131	3800972043763	Ø16 mm
189132	3800972043770	Ø18 mm
189133	3800972043787	Ø20 mm
189134	3800972043794	Ø22 mm
189135	3800972043800	Ø25 mm
189136	3800972043817	Ø28 mm
189137	3800972043824	Ø30 mm
189138	3800972043831	Ø32 mm
189139	3800972043848	Ø35 mm
189140	3800972043855	Ø40 mm
189141	3800972043862	Ø42 mm
189142	3800972043879	Ø45 mm
189143	3800972043886	Ø50 mm
189144	3800972043893	Ø55 mm
189145	3800972043909	Ø60 mm
189146	3800972043916	Ø65 mm

- Ceramics
- Porcelain
- Glass
- Granite
- Marble
- Cement Board



- ✓ Diamond grit for fast, precise & clean hole
- ✓ Reinforced steel body
- ✓ Dry use, no water needed
- ✓ Easy debris ejection slot
- ✓ 10mm hex shank for most drill drivers
- ✓ Sizes ranging 6mm to 65mm



DIAMOND FOR HARD CERAMICS HOLE SAWS DRY 12 PCS. SET

RD

• [BG] К-кт Боркорони Diamond Dry за бормашина • [RO] Carota diamantata pt ceramica dura taiere uscata

12 pcs
  
 Ø mm
 6 - 35



ART.NO.	BARCODE	SIZE
189147	3800972048423	Ø6 - Ø35 mm

DIAMOND FOR HARD CERAMICS HOLE SAWS DRY AL CASE SET

RD

• [BG] Боркорони Diamond Dry • [RO] Freza diamantata pentru frezare uscata

7 pcs
  
 Ø mm
 8 - 68



ART.NO.	BARCODE	SIZE
157851	3800972034594	M14 Ø8-68 mm

WAX FOR COOLING DIAMOND HOLE SAWS 9 PCS. SET

RD

• [BG] Вощък за охлаждане на диамантени боркорони • [RO] Ceara de racire pentru coroane diamantate

9 pcs
  
 



ART.NO.	BARCODE
159905	3800972041646

DIAMOND FOR HARD CERAMICS HOLE SAWS DRY

RD

• [BG] Боркорони Diamond Dry • [RO] Freza diamantata pentru frezare uscata

ART. NO.	BARCODE	SIZE
157838	3800972014794	Ø6 mm
157839	3800972014800	Ø8 mm
157840	3800972014817	Ø10 mm
157841	3800972014824	Ø12 mm
157872	3800972040731	Ø14 mm
157873	3800972040748	Ø16 mm
157842	3800972014831	Ø18 mm
157843	3800972014848	Ø20 mm
157844	3800972014855	Ø22 mm
157845	3800972014862	Ø25 mm
159906	3800972043619	Ø28 mm
157846	3800972014879	Ø30 mm
157874	3800972040755	Ø32 mm
157847	3800972014886	Ø35 mm
157848	3800972014893	Ø40 mm
157863	3800972039995	Ø42 mm
157849	3800972014909	Ø45 mm
159907	3800972043626	Ø50 mm
159909	3800972043633	Ø55 mm
157850	3800972014916	Ø60 mm
157864	3800972040007	Ø65 mm
159911	3800972043640	Ø32 mm
159912	3800972043657	Ø35 mm
159913	3800972043664	Ø40 mm
159914	3800972043671	Ø42 mm
159915	3800972043688	Ø45 mm
189158	3800972043695	Ø50 mm
189159	3800972043701	Ø55 mm
157865	3800972040014	Ø60 mm



GRANITE



FAIENCE



CERAMIC



DIAMOND HOLE SAWS DRY + BLADE + AL CASE 12 PCS. SET

RD

• [BG] Боркорони Diamond Dry M14 • [RO] Set 12 freze diamantate pentru frezare uscat

12 pcs
  
 Ø mm
 8 - 68
M14

  **VERY LONG LIFETIME**

  
 STONE MARBLE GRANITE

 
 FAIENCE

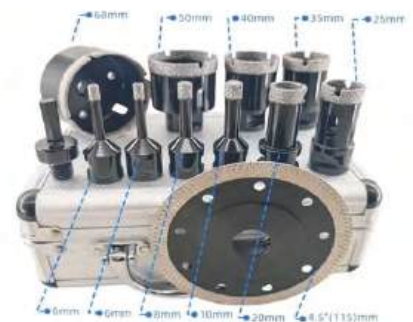

ART.NO.	BARCODE	SIZE
157866	3800972040021	M14 Ø6-68 mm

DIAMOND DISCS AND BITS ULTIMATE MULTI SET 28 PCS. SET

RD

• [BG] Диамантени дискове и борчета • [RO] Set 28 discuri și burghie diamantate



ART.NO.	BARCODE
157869	3800972040038

DIAMOND CORE DRILL 12 PCS. SET

RD

• [BG] Боркорони Diamond Dry • [RO] Set carote diamantate

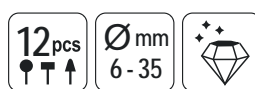

ART.NO.	BARCODE	SIZE
157867	3800972040045	Ø6-35 mm

DIAMOND CORE DRILL 6 PCS. SET

RD

• [BG] Боркорони Diamond Dry комплект • [RO] Set carote diamantate

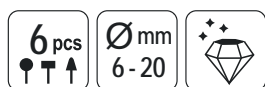

ART.NO.	BARCODE	SIZE
157868	3800972040052	Ø6-20 mm

DIAMOND CHAMFER BITS

RD

• [BG] Боркорона Конусна за фаски Diamond
• [RO] Freze diamantate pentru sanfren



ART.NO.	BARCODE	SIZE
157852	3800972040069	Ø38 mm x M14
157853	3800972040076	Ø50 mm x M14

DIAMOND BEVELING CHAMFER BIT

RD

• [BG] Боркорона Конусна за фаски Diamond
• [RO] Freza diamantata pentru șanfren



ART.NO.	BARCODE	SIZE
157854	3800972040083	Ø9 X 38 mm x M14
157855	3800972040090	Ø9 X 50 mm x M14

DIAMOND HOLE SAW FOR SINKS

RD

• [BG] Боркорона Diamond за мивки
• [RO] Panza diamantata tip carota pentru chiuvete



ART.NO.	BARCODE	SIZE
157870	3800972040106	Ø40-60 mm x M14
157871	3800972040113	Ø45-65 mm x M14
157856	3800972040120	Ø50-70 mm x M14

DIAMOND STEP CHAMFER DRILL BIT

RD

- [BG] Борче абразивно 3 степену Diamond
- [RO] Freza diamantată treptată pentru șanfren



ART.NO.	BARCODE	SIZE
157857	3800972040137	Ø20-35-50 mm x M14

DIAMOND SPECIAL MILLING BIT

RD

- [BG] Борче абразивно Diamond Special • [RO] Freze diamantate



ART.NO.	BARCODE	SIZE
157858	3800972040144	Ø6 x 37 x 62 mm x M14
157859	3800972040151	Ø10 x 25 x 46 mm x M14
157860	3800972040168	Ø15 x 20 x 42 mm x M14

DIAMOND MILLING BIT

RD

- [BG] Борче абразивно Diamond • [RO] Freza diamantata



ART.NO.	BARCODE	SIZE
157861	3800972040175	Ø25 x 50 x 70 mm x M14
157862	3800972040182	Ø25 x 50 x 65 mm x M14

DIAMOND DISC SET

RD

- [BG] Диск Диамантен • [RO] discuri diamantate



ART.NO.	BARCODE	SIZE
162120	3800972040243	40 x 40 mm x M14
162125	3800972040250	50 x 40 mm x M14
162126	3800972040267	60 x 40 mm x M14
162127	3800972040274	65 x 40 mm x M14
162128	3800972040281	70 x 40 mm x M14
162129	3800972040298	80 x 40 mm x M14

MINI DIAMOND SAW BLADE 6 PCS. SET

RD

- [BG] Диамантени дискове за рязане • [RO] Set discuri diamantate

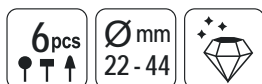

ART.NO.	BARCODE	SIZE
162132	3800972045156	22 - 44 mm

DIAMOND DISC 5 PCS. SET + THREAD ARBOR

RD

- [BG] Диамантени дискове • [RO] Set discuri diamantate



ART.NO.	BARCODE	SIZE
162115	3800972040236	50 x 10 mm x M14

THREAD ARBOR

RD

• [BG] Шпиндел M14 за дискове • [RO] Arbor cu filet

M14



ART.NO.	BARCODE
162130	3800972040304

HEXAGON SHANK ADAPTOR 3/8" TO THREAD ARBOR M14

RD

• [BG] Адаптер от HEX 3/8" към M14
• [RO] Adaptor arbor cu filet M14 hexagonală

M14



ART.NO.	BARCODE	SIZE
162131	3800972040311	M14 to 3/8"

DIAMOND GRINDING WHEEL U SHAPE GROOVES

RD

• [BG] Диск диамантен за шлайфване • [RO] Disc diamantat de rectificat



ART.NO.	BARCODE	SIZE
209948	3800972040342	5 mm
209949	3800972040359	10 mm
209950	3800972040366	15 mm

DIAMOND GRINDING WHEEL - ROUND WHEEL

RD

• [BG] Диск диамантен за кръгло шлайфване • [RO] Disc diamantat de rectificat



ART.NO.	BARCODE	SIZE
209951	3800972040373	10 mm
209952	3800972040380	15 mm
209953	3800972040397	20 mm
209954	3800972040403	30 mm

DIAMOND GRINDING WHEEL - DEMI-BULLNOSE EDGE

RD

• [BG] Диск диамантен за полукръгло шлайфване
• [RO] Disc diamantat de rectificat



ART.NO.	BARCODE	SIZE
209955	3800972040410	75 x 20 x 10 mm
209956	3800972040427	75 x 20 x 15 mm
209957	3800972040434	75 x 20 x 20 mm
209958	3800972040441	75 x 20 x 25 mm
209959	3800972040458	75 x 20 x 30 mm

DIAMOND CUTTING DISC DRY

RD

• [BG] Диск диамантен DRY • [RO] Disc diamantat segmentat



FAIENCE CONCRETE BRICKS



ART.NO.	BARCODE	SIZE	MODEL
162101	3800123126123	Ø115 x 22.2 mm (20) mm	RD-DD01
162207	3800972032859	Ø125 x 22.23 mm (10) mm	RDP-DD28
162104	3800123126390	Ø125 x 22.23 mm (30) mm	RD-DD02
162124	3800972022669	Ø150 x 25.4 mm (22.2) mm	RD-DD23
162107	3800123126406	Ø180 x 25.4 mm (22.2) mm	RD-DD03
162110	3800123126482	Ø230 x 25.4 mm (22.2) mm	RD-DD04

DIAMOND CUTTING DISC TURBO

RD-DD05

• [BG] Диск диамантен TURBO • [RO] Disc diamantat segmentat TURBO



FAIENCE CONCRETE BRICKS



ART.NO.	BARCODE	SIZE	MODEL
162102	3800123126444	Ø115 x 22.2 mm	RD-DD05
162105	3800123126451	Ø125 x 22.2 mm	RD-DD06
162108	3800123126468	Ø180 x 22.2 (25.4) mm	RD-DD07
162111	3800123126499	Ø230 x 22.2 (25.4) mm	RD-DD08

DIAMOND CUTTING DISC DRY SUPER THIN

RDP-DD27

• [BG] Диск диамантен DRY • [RO] Disc diamantat segmentat



FAIENCE CONCRETE BRICKS



ART.NO.	BARCODE	SIZE
162206	3800972032842	Ø115 x 22.2 mm 15 mm

DIAMOND CUTTING DISC UNIVERSAL

RD-DD24

• [BG] Диск диамантен • [RO] Disc diamantat



FAIENCE CONCRETE BRICKS



ART.NO.	BARCODE	SIZE
162203	3800972029156	Ø125 x 22.2 mm 20 mm

DIAMOND CUTTING DISC UNIVERSAL

RDP-DD26

• [BG] Диск диамантен • [RO] Disc diamantat



FAIENCE CONCRETE BRICKS



ART.NO.	BARCODE	SIZE
162205	3800972032835	Ø125 x 22.2 mm 20 mm

DIAMOND GLASS CUTTING DISC

RD-G01

• [BG] Диск диамантен стъкло • [RO] Disc diamantat pentru taiat sticla 1



MARBLE GRANITE CERAMIC



GLASS



ART.NO.	BARCODE	SIZE
162118	3800972040328	Ø125 x 22.23 mm 15 mm

DIAMOND GLASS CUTTING/GRINDING DISC

RD-G02

• [BG] Диск диамантен стъкло • [RO] Disc diamantat pentru taiere sticla



MARBLE GRANITE CERAMIC



GLASS



ART.NO.	BARCODE	SIZE
162119	3800972040335	Ø125 x 22.23 mm 30 mm

DIAMOND TUCK POINT SAW BLADE

RD

• [BG] Диск диамантен DRY за канали • [RO] Disc oala pentru slefuit beton



ART.NO.	BARCODE	SIZE
162113	3800972041189	Ø125x22.2x8 mm
162114	3800972041196	Ø125x22.2x11 mm

DIAMOND CUTTING DISC TURBO SUPER THIN 1.5 mm

RD-DD21

• [BG] Диск диамантен TURBO • [RO] Disc diamantat segmentat TURBO



ART.NO.	BARCODE	SIZE	MODEL
162201	3800972016415	Ø115 x 22.2 mm	RD-DD21
162202	3800972016422	Ø125 x 22.2 mm	RD-DD22

DIAMOND CUTTING DISC WET

• [BG] Диск диамантен WET • [RO] Disc diamantat continuu WET



ART.NO.	BARCODE	SIZE	MODEL
162103	3800123126413	Ø115 x 22.2 mm	RD-DD09
162106	3800123126420	Ø125 x 22.2 mm	RD-DD10
162109	3800123126437	Ø180 x 22.2 (25.4) mm	RD-DD11
162116	3800123127472	Ø200 x 22.2 (25.4) mm	RD-DD16
162112	3800123126611	Ø230 x 22.2 mm	RD-DD12
162301	3800972025226	Ø250 x 25.4 mm	RD
162117	3800123127489	Ø300 x 25.4 mm	RD-DD17

DIAMOND CUTTING DISC 2- SIDED M14 TWO-SIDED

RD-DD25

• [BG] Диск диамантен двустранен • [RO] Disc diamant.



ART.NO.	BARCODE	SIZE
162204	3800972029163	Ø115 x 22.2 mm

DIAMOND GRINDING HEAD FINE

RD

• [BG] Диск диамантен за шлайфане • [RO] Disc diamantat pentru slefuire



ART.NO.	BARCODE	SIZE
209936	3800972032811	Ø125 x 22.2 mm

DIAMOND GRINDING HEAD

RD

• [BG] Диск диамантен за шлайфане • [RO] Disc diamantat pentru slefuire

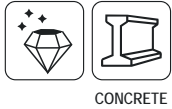

CONCRETE

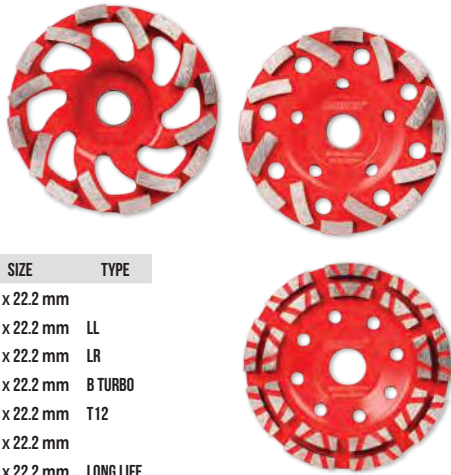

ART.NO.	BARCODE	SIZE	TYPE
209931	3800123150678	Ø125 x 22.2 mm	
209943	3800972038264	Ø125 x 22.2 mm	LL
209944	3800972038271	Ø125 x 22.2 mm	LR
209945	3800972038288	Ø125 x 22.2 mm	B TURBO
209947	3800972039094	Ø125 x 22.2 mm	T12
209932	3800123150685	Ø180 x 22.2 mm	
209946	3800972038295	Ø180 x 22.2 mm	LONG LIFE

DIAMOND GRINDING HEAD TURBO 20 mm

RD

• [BG] Диск диамантен за шлайфане • [RO] Disc diamantat pentru slefuire



ART.NO.	BARCODE	SIZE
209941	3800972034020	Ø125 x 22.2 mm

DIAMOND GRINDING HEAD LONG LIFE

RD

• [BG] Диск диамантен за шлайфане • [RO] Disc diamantat pentru slefuire



ART.NO.	BARCODE	SIZE
209933	3800972029149	Ø125 x 22.2 mm

CUTTING DISC METAL

RD

• [BG] Диск за метал • [RO] Disc pentru taiat metal

ART.NO.	BARCODE	SIZE
160118	3800123119538	Ø115 x 1.0 x 22.2 mm
160115	3800123113000	Ø115 x 1.2 x 22.2 mm
160106	3800123126314	Ø115 x 1.6 x 22.2 mm
160101	3800123126031	Ø115 x 3.2 x 22.2 mm
160119	3800123119545	Ø125 x 1.0 x 22.2 mm
160116	3800123113604	Ø125 x 1.2 x 22.2 mm
160117	3800123113611	Ø125 x 1.6 x 22.2 mm
160102	3800123126550	Ø125 x 3.2 x 22.2 mm
160113	3800123127274	Ø150 x 3.2 x 22.2 mm
160107	3800123126321	Ø180 x 2.0 x 22.2 mm
160103	3800123126048	Ø180 x 3.2 x 22.2 mm
160108	3800123126338	Ø230 x 2.0 x 22.2 mm
160104	3800123126086	Ø230 x 3.2 x 22.2 mm
160105	3800123126284	Ø355 x 3.2 x 25.4 mm



GRINDING DISC METAL

RD

• [BG] Диск за шлайфане • [RO] Disc abraziv



ART.NO.	BARCODE	SIZE
160109	3800123126604	Ø115 x 6 x 22.2 mm
160110	3800123126567	Ø125 x 6 x 22.2 mm
160111	3800123126574	Ø180 x 6 x 22.2 mm
160112	3800123126581	Ø230 x 6 x 22.2 mm

CUTTING DISC STONE

RD

• [BG] Диск за неметал • [RO] Disc taieri piatra



STONE



ART.NO.	BARCODE	SIZE
161101	3800123126307	Ø115 x 3.2 x 22.2 mm
161102	3800123126093	Ø180 x 3.2 x 22.2 mm
161103	3800123126109	Ø230 x 3.2 x 22.2 mm

CUTTING DISC METAL A60T INOX

RDP

• [BG] Диск за метал • [RO] Disc pentru taiat meta

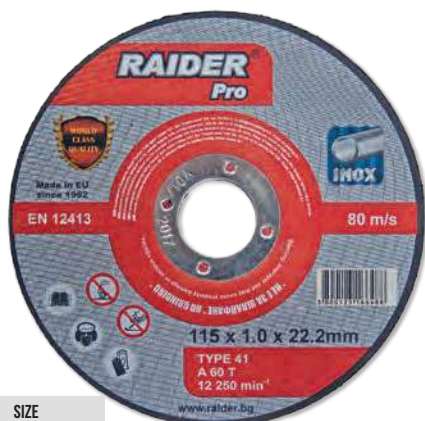

ART.NO.	BARCODE	SIZE
160120	3800123166471	Ø115 x 1.0 x 22.2 mm
160121	3800123166488	Ø125 x 1.0 x 22.2 mm
160155	3800972024526	Ø125 x 1.6 x 22.2 mm

CUTTING DISC METAL

RDP

• [BG] Диск за метал • [RO] Disc pentru taiat meta



ART.NO.	BARCODE	SIZE
160122	3800123166495	Ø115 x 2.5 x 22.2 mm
160123	3800123166501	Ø115 x 3.0 x 22.2 mm
160124	3800123166518	Ø125 x 2.5 x 22.2 mm
160125	3800123166525	Ø125 x 3.0 x 22.2 mm
160126	3800123166532	Ø180 x 3.0 x 22.2 mm
160127	3800123166549	Ø230 x 2.0 x 22.2 mm
160128	3800123166556	Ø230 x 3.0 x 22.2 mm
160129	3800123166563	Ø350 x 3.5 x 25.4 mm

CUTTING DISC METAL 10 PCS. SET A60T INOX

RDP

• [BG] Диск за метал 10 бр. • [RO] Disc pentru taiat meta Set 10 pcs.

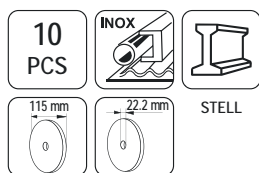

ART.NO.	BARCODE	SIZE
160157	3800972033948	Ø115 x 1.0 x 22.2 mm

CUTTING DISC METAL 10 PCS. SET A60T INOX

RDP

• [BG] Диск за метал 10 бр. • [RO] Disc pentru taiat meta Set 10 pcs

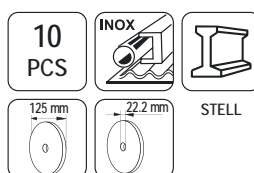

ART.NO.	BARCODE	SIZE
160158	3800972033955	Ø125 x 1.0 x 22.2 mm

CUTTING DISC METAL 50 PCS. SET A60T INOX

RDP

• [BG] Диск за метал 50 бр. • [RO] Disc pentru taiat meta Set 50 pcs

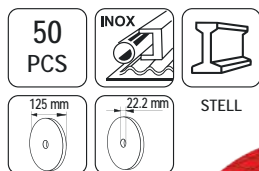

ART.NO.	BARCODE	SIZE
160160	3800972039377	Ø125 x 1.0 x 22.2 mm

CUTTING DISC METAL 5 PCS. SET A60T INOX

RDP

• [BG] Диск за метал 5 бр. • [RO] Disc pentru taiat meta Set 5 pcs

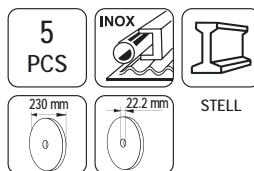

ART.NO.	BARCODE	SIZE
160159	3800972033962	Ø230 x 2.0 x 22.2 mm

GRINDING DISC METAL

RDP

• [BG] Диск за шлайфане • [RO] Disc pentru slefuit metal

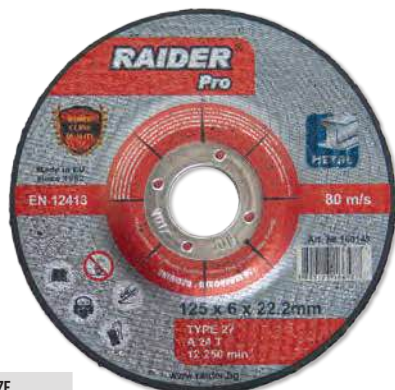

ART.NO.	BARCODE	SIZE
160144	3800123166570	Ø115 x 6 x 22.2 mm
160145	3800123166587	Ø125 x 6 x 22.2 mm
160146	3800123166594	Ø180 x 6 x 22.2 mm
160147	3800123166600	Ø230 x 6 x 22.2 mm

CUTTING DISC STONE

RDP

• [BG] Диск за неметал • [RO] Disc pentru taiat piatra



STONE

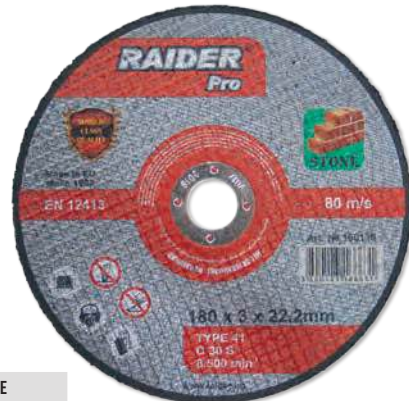

ART.NO.	BARCODE	SIZE
160134	3800123166617	Ø115 x 3 x 22.2 mm
160135	3800123166624	Ø125 x 3 x 22.2 mm
160136	3800123166631	Ø180 x 3 x 22.2 mm
160137	3800123166648	Ø230 x 3 x 22.2 mm

CARBIDE MULTI WHEEL CUTTING DISC

RDP

• [BG] Диск за ъглошлайф Carbide Multi Wheel • [RO] Disc debitare multmaterial cu carbura



WOOD FAIENCE BRICKS



ART.NO.	BARCODE	SIZE
160153	3800972015234	Ø115 x 22.2 mm
160154	3800972015241	Ø125 x 22.2 mm

WOOD CARVING CHAIN DISC

RD

• [BG] Диск с верига за дърво • [RO] Disc circular pentru lemn



WOOD



ART.NO.	BARCODE	SIZE
140131	3800972027091	Ø125 x 22.2 mm

WOOD GRINDING RASP DISC

RD

• [BG] Диск за ъглошлайф за дърво плосък • [RO] Disc de slefuire pentru lemn



WOOD



ART.NO.	BARCODE	SIZE
140143	3800972031203	Ø125 x 22.2 mm

WOOD GRINDING SHAPING DISC

RD

• [BG] Диск за ъглошлайф за дърво овален • [RO] Disc taiere lemn



WOOD



ART.NO.	BARCODE	SIZE
140144	3800972031210	Ø125 x 22.2 mm

WOOD CUTTING AND RASP DISC 28T

RD

• [BG] Диск за ъглошлайф за дърво • [RO] Disc taiere lemn

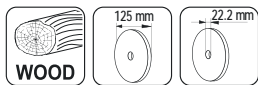

ART.NO.	BARCODE	SIZE
140145	3800972031227	Ø125 x 22.2 mm

CARVING BURR SPHERE WOOD FOR ANGLE GRINDER

RD

• [BG] Шлайфгрифер сферичен за ъглошлайф за дърво
• [RO] Freza sferica lemn pentru polizor unghiular



ART.NO.	BARCODE	SIZE
140152	3800972039131	Ø40 mm M14

CIRCULAR SAW BLADE TUNGSTEN CARBIDE TIPPED

RD • [BG] Диск за циркуляр • [RO] Disc circular pentru lemn

ART.NO.	BARCODE	SIZE	MODEL
163113	3800123126079	Ø115x24Tx22.2 mm	RD-SB13
163134	3800123158247	Ø115x36Tx22.2 mm	RD-SB28
163131	3800123141843	Ø125x40Tx22.2 mm	
163106	3800123126628	Ø160x24Tx20 mm	RD-SB06
163102	3800123126116	Ø180x24Tx20 mm	RD-SB01
163128	3800123139420	Ø185x24Tx20 mm	
163132	3800123141850	Ø185x60Tx20 mm	
163135	3800123158810	Ø190x24Tx20 mm	RD-SB29
163129	3800123139437	Ø190x40Tx25.4 mm	
163136	3800123158827	Ø190x80Tx20 mm	RD-SB30
163145	3800972019584	Ø190x24Tx30 mm	
163146	3800972019591	Ø190x36Tx30 mm	
163147	3800972019607	Ø190x48Tx30 mm	
163148	3800972019614	Ø190x60Tx30 mm	
163130	3800123139444	Ø200x24Tx16 mm	
163149	3800972019621	Ø200x24Tx30 mm	
163104	3800123126635	Ø210x24Tx25.4 mm	RD-SB04
163133	3800123143694	Ø210x24Tx30 mm	
163150	3800972019638	Ø210x48Tx30 mm	
163115	3800123160004	Ø210x60Tx30 mm	
163103	3800123126383	Ø230x40Tx22.2 mm	RD-SB02
163116	3800123160707	Ø250x48Tx30 mm	
163117	3800123160714	Ø250x60Tx30 mm	
163151	3800972019645	Ø254x40Tx30 mm	
163114	3800123127953	Ø254x60Tx25.4 mm	RD-SB14
163152	3800972019652	Ø254x80Tx30 mm	
163107	3800123126659	Ø300x56Tx25.4 mm	RD-SB07
163110	3800123126949	Ø300x56Tx30 mm	RD-SB10
163144	3800972010772	Ø305x100Tx30 mm	
163126	3800123127496	Ø315x40Tx30 mm	RD-SB26
163108	3800123126666	Ø350x56Tx25.4 mm	RD-SB08
163111	3800123126956	Ø350x56Tx30 mm	RD-SB11
163109	3800123126673	Ø400x56Tx25.4 mm	RD-SB09
163112	3800123126963	Ø400x56Tx30 mm	RD-SB12



ALUMINUM CUTTING TUNGSTEN CARBIDE TIPPED SAW BLADE

RD

• [BG] Диск за циркуляр за алуминий • [RO] Disc circular pentru aluminiu

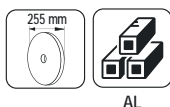

ART.NO.	BARCODE	SIZE
163118	3800123160721	Ø255x100Tx25.4 mm

CIRCULAR SAW BLADE TCT TEFLON ULTRA THIN

RD

• [BG] Диск за циркуляр TCT Teflon • [RO] Panza circulara TCT teflon subtire



ART.NO.	BARCODE	SIZE
163153	3800972044067	Ø125x1.5x24Tx22.3 mm
163154	3800972044074	Ø165x1.5x24Tx22(16) mm
163155	3800972044081	Ø165x1.5x30Tx22(16) mm
163156	3800972044098	Ø184x1.7x1.1x24Tx20 mm
163157	3800972044104	Ø184x1.7x1.1x42Tx20 mm

CURVE FLAP DISC CERAMIC

RD

• [BG] Диск ламелен CURVE ceramic • [RO] Disc oala pentru slefuit ceramic



CERAMIC



ART.NO.	BARCODE	SIZE
164141	3800972042209	Ø 125 mm G-40
164142	3800972042216	Ø 125 mm G-60
164143	3800972042223	Ø 125 mm G-80
164144	3800972042230	Ø 125 mm G-100
164145	3800972042247	Ø 125 mm G-120

CURVE FLAP DISC ZIRCONIA

RD

• [BG] Диск ламелен CURVE zirconia • [RO] Disc oala pentru slefuit zirconiu



ZIRCONIA

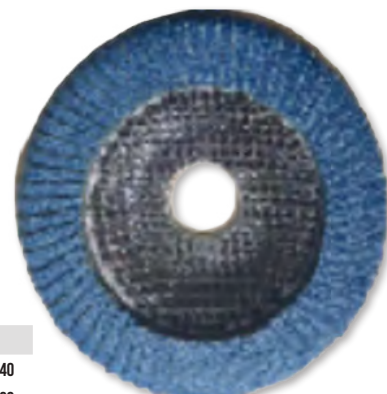

ART.NO.	BARCODE	SIZE
164124	3800972023741	Ø 125 mm G-40
164125	3800972023758	Ø 125 mm G-60
164126	3800972023765	Ø 125 mm G-80
164127	3800972023772	Ø 125 mm G-100
164128	3800972023789	Ø 125 mm G-120

FLAP DISC CERAMIC

RD

• [BG] Диск ламелен ceramic • [RO] Disc pentru slefuit ceramic



CERAMIC



ART.NO.	BARCODE	SIZE
164146	3800972042254	Ø 125 mm G-40
164147	3800972042261	Ø 125 mm G-60
164148	3800972042278	Ø 125 mm G-80
164149	3800972042285	Ø 125 mm G-100
164150	3800972042292	Ø 125 mm G-120

FLAP DISC ZIRCONIA

RD

• [BG] Диск ламелен zirconia • [RO] Disc circular cu lamele smirghel zirconiu



ZIRCONIA



ART.NO.	BARCODE	SIZE
164131	3800972023819	Ø 125 mm G-40
164132	3800972023826	Ø 125 mm G-60
164133	3800972023833	Ø 125 mm G-80
164134	3800972023840	Ø 125 mm G-100
164135	3800972023857	Ø 125 mm G-120
164140	3800972033993	Ø 125 mm G-150

FLAP DISC

RD

• [BG] Диск ламелен • [RO] Disc circular cu lamele smirghel



Type
29

80
m/s

13 300
min⁻¹

ART.NO.	BARCODE	SIZE
164112	3800123127298	Ø 115 mm A-40
164102	3800123126352	Ø 115 mm A-60
164103	3800123126369	Ø 115 mm A-80
164104	3800123126376	Ø 115 mm A-100
164105	3800123126543	Ø 115 mm A-120
164113	3800123150746	Ø 115 mm A-150
164118	3800123151095	Ø 125 mm A-40
164119	3800123151101	Ø 125 mm A-60
164120	3800123151118	Ø 125 mm A-80
164121	3800123151125	Ø 125 mm A-100
164122	3800123151132	Ø 125 mm A-120
164123	3800123151149	Ø 125 mm A-150



SOFT FLAP DISC

RD

• [BG] Диск ламелен Soft • [RO] Disc pentru slefuit soft



ART.NO.	BARCODE	SIZE
164129	3800972023796	Ø 115 mm A-40
164130	3800972023802	Ø 115 mm A-60
164151	3800972042308	Ø 115 mm A-80
164152	3800972042315	Ø 115 mm A-100
164153	3800972042322	Ø 115 mm A-120

BBL NON-WOVEN FLAP DISC

RD

• [BG] Диск ламелен BBL • [RO] Disc abraziv de finisare

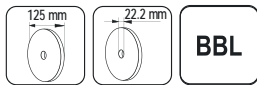

ART.NO.	BARCODE	SIZE
164154	3800972042339	Ø125 YELLOW 40-60
164155	3800972042346	Ø125 RED 80-100
164156	3800972042353	Ø125 BLUE 100-120
164157	3800972042360	Ø125 GREY 150

FELT FLAP POLISHING DISC

RD

• [BG] Диск ламелен за полиране • [RO] Disc din pasla penru polishare

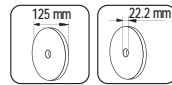

ART.NO.	BARCODE	SIZE
164158	3800972042377	Ø125

CLEANING FLEECE DISC BLACK

RD

• [BG] Диск почистващ Black • [RO] Disc curatare vopsea negru

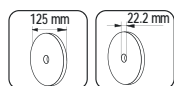

ART.NO.	BARCODE	SIZE
164137	3800972029170	Ø125x22.2x14 mm

CLEANING FLEECE DISC ORANGE

RD

• [BG] Диск почистващ Orange • [RO] Disc curatare vopsea portocaliu

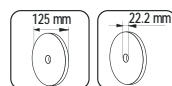

ART.NO.	BARCODE	SIZE
164138	3800972033979	Ø125x22.2x14 mm

CLEANING FLEECE DISC BLUE

RD

• [BG] Диск почистващ Blue • [RO] Disc curatare vopsea albastru

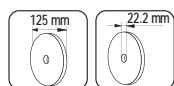

ART.NO.	BARCODE	SIZE
164139	3800972033986	Ø125x22.2x14 mm

FLAP WHEEL BURNISHING MOP FOR POWER DRILL

RD

• [BG] Диск за сваляне на ръжда за бормашина
• [RO] Perie segmentata smirghel-cu tija



ART.NO.	BARCODE	SIZE
209920	3800123127625	Ø64 mm

STEEL TUBE BRUSH WITH SHANK

RD

- [BG] Четка телена за бормашина Тип Шомпол
- [RO] Perie de sarma pt. tevi cu ax pentru bormasina



ART.NO.	BARCODE	SIZE
177104	3800972040786	Ø20x55x200 mm
177105	3800972040793	Ø26x55x200 mm
177106	3800972040809	Ø32x55x200 mm

BRASS-COATED WIRE WHEEL BRUSH WITH SHANK

RD

- [BG] Четка за бормашина плоска месинг
- [RO] Perie circulara din sarma ptr bormasina



ART.NO.	BARCODE	SIZE
170104	3800123102073	Ø50 mm (2")
170105	3800123102080	Ø75 mm (3")
170106	3800123102097	Ø100 mm (4")

STAINLESS STEEL FLAT WIRE BRUSH WITH SHANK

RD

- [BG] Четка за бормашина плоска
- [RO] Perie de sarma cu tija pentru bormasina



ART.NO.	BARCODE	SIZE
170110	3800972040762	Ø75 mm (3")

BRASS-COATED WIRE CUP BRUSH WITH SHANK

RD

- [BG] Четка за бормашина камбана месинг
- [RO] Perie sarma cu tija ptr bormasina



ART.NO.	BARCODE	SIZE
170101	3800123102042	Ø50 mm (2")
170102	3800123102059	Ø75 mm (3")
170103	3800123102066	Ø100 mm (4")

TWIST KNOT WIRE WHEEL BRUSH WITH SHANK

RD

- [BG] Четка за бормашина плоска плетена
- [RO] Perie circulara rotativa cu tija



ART.NO.	BARCODE	SIZE
170108	3800123163678	Ø75 mm (3")

STAINLESS STEEL CRIMPED WIRE CUP BRUSH WITH SHANK

RD

- [BG] Четка за бормашина камбана INOX
- [RO] Perie de sarma cu toroane si tija pentru bormasina



ART.NO.	BARCODE	SIZE
170111	3800972040779	Ø75 mm (3")

TWIST KNOT WIRE CUP BRUSH WITH SHANK

RD

- [BG] Четка за бормашина камбана плетена
- [RO] Perie tip cupa- rotativa cu tija



ART.NO.	BARCODE	SIZE
170107	3800123163661	Ø25 mm (1")

TWIST KNOT WIRE CUP BRUSH WITH SHANK

RD

- [BG] Четка за бормашина камбана плетена
- [RO] Perie tip cupa- rotativa cu tija



ART.NO.	BARCODE	SIZE
170109	3800123163685	Ø75 mm (3")

TWIST KNOT WIRE WHEEL BRUSH FOR ANGLE GRINDER

RD

- [BG] Четка телена за ъглошлайф плоска плетена
- [RO] Perie circulara rotativa pentru polizor unghiular



ART.NO.	BARCODE	SIZE
171108	3800123102172	Ø100x22.2 mm
171109	3800123102189	Ø150x22.2 mm
171110	3800123102288	Ø150x22.2 mm

BRASS-COATED WIRE CUP BRUSH FOR ANGLE GRINDER

RD

- [BG] Четка телена за ъглошлайф камбана месинг
- [RO] Perie circulara rotativa pentru polizor unghiular



ART.NO.	BARCODE	SIZE
171103	3800123102103	Ø75 mm M14
171106	3800123102110	Ø100 mm M14
171121	3800123151248	Ø125 mm M14

TWIST KNOT WIRE CUP BRUSH FOR ANGLE GRINDER

RD

- [BG] Четка телена за ъглошлайф камбана плетена
- [RO] Perie sarma rotativa cu toroane clopot



ART.NO.	BARCODE	SIZE
171101	3800123102127	Ø75 mm M14
171104	3800123102134	Ø100 mm M14
171107	3800123102141	Ø125 mm M14

TWIST KNOT WIRE CUP BRUSH FOR ANGLE GRINDER

RD

- [BG] Четка телена за ъглошлайф камбана плетена
- [RO] Perie circulara rotativa pentru polizor unghiular



ART.NO.	BARCODE	SIZE
171102	3800123102158	Ø75 mm M14
171105	3800123102165	Ø100 mm M14

BRASS-COATED WIRE CONICAL BRUSH FOR ANGLE GRINDER

RD

- [BG] Четка телена за ъглошлайф конусна месинг
- [RO] Perie conica din sarma alamita pt polizor unghiular

M14



ART.NO.	BARCODE	SIZE
171130	3800972025851	Ø115 mm M14
171131	3800972025868	Ø125 mm M14

BRUSH FOR ANGLE GRINDER

RD

- [BG] Четка телена за ъглошлайф
- [RO] Perie circulara rotativa pentru polizor unghiular

M14



ART.NO.	BARCODE	SIZE
171122	3800123163630	Ø100 mm M14

BRASS-COATED WIRE WHEEL BRUSH FOR BENCH GRINDER

RD

- [BG] Четка телена за шмиргел месинг
- [RO] Perie circulara din sarma otel acoperire alama



ART.NO.	BARCODE	SIZE
172101	3800123102196	Ø125x20 mm (5")
172102	3800123102202	Ø150x20 mm (6")
172103	3800123102219	Ø200x20 mm (8")

PLASTIC BRUSHES 3 PCS. SET

RD

- [BG] Четки за винтоверт 3 бр. к-кт
- [RO] Set 3 perii plastic



ART.NO.	BARCODE	SIZE
170113	3800972024403	Ø50H26 mm, Ø100H26 mm, Ø90H90 mm, Ø100 mm M14 HEX 1/4"

PLASTIC BRUSHES 5 PCS. SET

RD

- [BG] Четки за винтоверт с удължение
- [RO] Set 5 perii plastic



ART.NO.	BARCODE	SIZE
170114	3800972041981	Ø50, Ø64, Ø90, Ø100 mm, 150 mm HEX 1/4"

BRASS-COATED WIRE CUP BRUSH 3 PCS. SET

RD

- [BG] Комплект четки за бормашина
- [RO] Perii sarma ptr bormasina set 3 buc.



ART.NO.	BARCODE
177101	3800123102240

BRASS-COATED WIRE CUP BRUSH 20 PCS. SET

RD

• [BG] Комплект четки за бормашина • [RO] Perii sarma ptr bormasina set 20 buc.

20 pcs
↑ ↑ ↑



ART.NO.	BARCODE
177103	3800123102264



SANDING SHEETS FOR SANDER WITH 8 HOLES 10 PCS.

RD

• [BG] Шкурка за виброшлайф с 8 отвора • [RO] Set 10 coli smirghel perforat

x10
8 holes

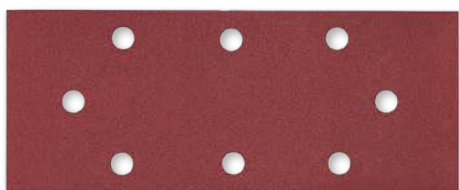

ART.NO.	BARCODE	SIZE	P
180101	3800123135446	93x230 mm	P60
180112	3800123150555	93x230 mm	P80
180102	3800123135453	93x230 mm	P100
180103	3800123135460	93x230 mm	P120
180113	3800123150562	93x230 mm	P150
180104	3800123135477	93x230 mm	P180
180105	3800123135484	93x230 mm	P240

SANDING SHEETS FOR SANDER WITH 14 HOLES 10 PCS.

RD

• [BG] Шкурка за виброшлайф с 14 отвора • [RO] Set 10 coli smirghel perforat

x10
14 holes



ART.NO.	BARCODE	SIZE	P
180114	3800123150579	115x280 mm	P40
180106	3800123135491	115x280 mm	P60
180115	3800123150586	115x280 mm	P80
180107	3800123135507	115x280 mm	P100
180108	3800123135514	115x280 mm	P120
180116	3800123150593	115x280 mm	P150
180109	3800123135521	115x280 mm	P180
180110	3800123135538	115x280 mm	P220

SANDING BELTS FOR BELT SANDER 5 PCS.

RD

• [BG] Шкурка за лентов шлайф • [RO] Set 5 benzi smirghel neperforat

x5



ART.NO.	BARCODE	SIZE	P
183111	3800123135170	75x457 mm	P40
183112	3800123135187	75x457 mm	P60
183113	3800123135194	75x457 mm	P80
183114	3800123135200	75x457 mm	P100
183115	3800123135224	75x457 mm	P120
183106	3800123135996	75x533 mm	P40
183107	3800123136009	75x533 mm	P60
183108	3800123136207	75x533 mm	P80
183109	3800123135156	75x533 mm	P100
183110	3800123135163	75x533 mm	P120

PAPER SANDING DISCS 10 PCS.

RD

• [BG] Шкурка VELCRO • [RO] Set 10 discuri smirghel neperforat Velcro

x10
VELCRO



ART.NO.	BARCODE	SIZE	P
180702	3800123134906	Ø115 mm	K40
180703	3800123134913	Ø115 mm	K60
180704	3800123134920	Ø115 mm	K80
180705	3800123134937	Ø115 mm	K100
180706	3800123134944	Ø115 mm	K120
180731	3800972025158	Ø125 mm	K40
180732	3800972025165	Ø125 mm	K60
180733	3800972025172	Ø125 mm	K80
180734	3800972025189	Ø125 mm	K100
180735	3800972025196	Ø125 mm	K120

PAPER SANDING DISCS VELCRO FOR RANDOM ORBIT SANDER WITH 8 HOLES 10 PCS.

RD

• [BG] Шкурка VELCRO с 8 отвора • [RO] Set 10 discuri smirghel perforat



ART.NO.	BARCODE	SIZE	P
181101	3800123135545	Ø 125 mm	K60
181102	3800123135552	Ø 125 mm	K120
181103	3800123135569	Ø 125 mm	K180
181104	3800123135576	Ø 125 mm	K240

MESH CERAMIC DISCS VELCRO 10 PCS.

RD

• [BG] Шкурка мрежеста VELCRO Ceramic
• [RO] Set 10 buc disc plasa ceramica cu vlcro



ART.NO.	BARCODE	SIZE	P
180755	3800972044234	Ø 125 mm	P60
180756	3800972044241	Ø 125 mm	P80
180757	3800972044258	Ø 125 mm	P100
180758	3800972044265	Ø 125 mm	P120
180759	3800972044272	Ø 125 mm	P180
180760	3800972044289	Ø 125 mm	P220
180761	3800972044296	Ø 125 mm	P320
180762	3800972044302	Ø 125 mm	P400

PAPER SANDING DISCS FOR RANDOM ORBIT SANDER WITH 6 HOLES 10 PCS.

RD

• [BG] Шкурка VELCRO с 6 отвора • [RO] Set 10 discuri smirghel perforat Velcro



ART.NO.	BARCODE	SIZE
180713	3800123165412	Ø 150 mm K60
180714	3800123165429	Ø 150 mm K80
180715	3800123165436	Ø 150 mm K100
180716	3800123165443	Ø 150 mm K120
180717	3800123165450	Ø 150 mm K150
180718	3800123165467	Ø 150 mm K180
180719	3800123165474	Ø 150 mm P220
180720	3800123165481	Ø 150 mm P240

ABRASIVE FLAP WHEEL FOR POWER DRILL

RD

• [BG] Шкурка за бормашина ламелна • [RO] Perie segmentata smirghel



ART.NO.	BARCODE	SIZE
183501	3800123135712	Ø50 mm K60
183502	3800123135729	Ø50 mm K120
183503	3800123135736	Ø60 mm K60
183504	3800123135743	Ø60 mm K120
183505	3800123135750	Ø80 mm K60
183506	3800123135767	Ø80 mm K120

SANDING SHEETS LATEX PAPER WATERPROOF 50 PCS.

RD

• [BG] Шкурка водна латексова • [RO] Foi abrazive din latex, impermeabile

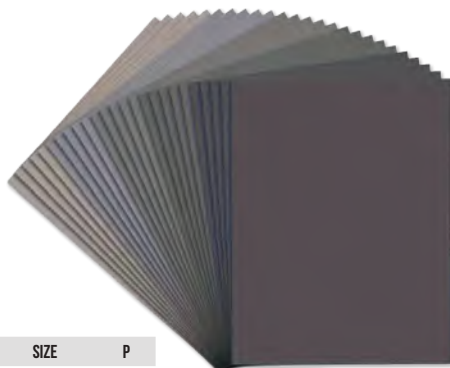
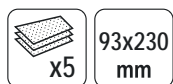

ART.NO.	BARCODE	SIZE	P
180763	3800972048362	230x280 mm	P2000
180764	3800972048379	230x280 mm	P2500
180765	3800972048386	230x280 mm	P3000
180766	3800972048393	230x280 mm	P4000
180767	3800972048416	230x280 mm	P5000

DRYWALL PLASTER SANDING SCREEN 5 PCS.

RD

• [BG] Шкурка мрежа от силициев карбид
• [RO] Set 5 coli tip plasa slefuit smirghel

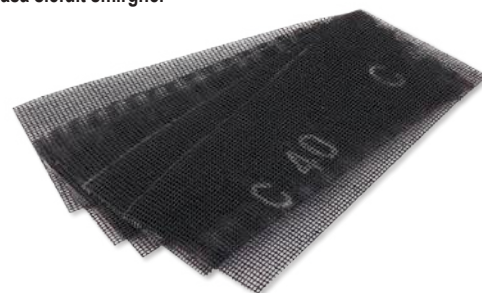
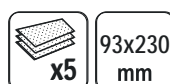

ART.NO.	BARCODE	SIZE	P
184101	3800123150609	93x230 mm	P40
184102	3800123150616	93x230 mm	P60
184103	3800123150623	93x230 mm	P80
184104	3800123150630	93x230 mm	P100
184105	3800123150647	93x230 mm	P120
184106	3800123150654	93x230 mm	P150

SANDING SPONGE

RD

• [BG] Гъба абразивна • [RO] Burete smirghel



ART.NO.	BARCODE	SIZE	P
189101	3800123136269	100x70x25 mm	P40
189102	3800123136276	100x70x25 mm	P60
189103	3800123136283	100x70x25 mm	P80
189104	3800123136290	100x70x25 mm	P100
189105	3800123136306	100x70x25 mm	P120
189106	3800123136313	100x70x25 mm	P150

SANDING SPONGE DIAMOND

RD

• [BG] Гъба абразивна Diamond • [RO] Burete abraziv



ART.NO.	BARCODE	SIZE	P
189107	3800972040199	95x60x32 mm	P60
189108	3800972040205	95x60x32 mm	P120
189109	3800972040212	95x60x32 mm	P200
189110	3800972040229	95x60x32 mm	P400

ADAPTER 2 IN 1 FOR SCREWDRIVER BITS AND SOCKETS

RD

• [BG] Адаптер 2 в 1 за битове и вложки
• [RO]



ART.NO.	BARCODE	SIZE
157807	3800972049345	2 IN 1 1/4" HEX

ADAPTERS SET

RD

• [BG] Адаптери К-кт • [RO] Set 3 adaptori patrati



ART.NO.	BARCODE	SIZE
158904	3800123173486	1/4" HEX TO 1/4", 3/8", 1/2" SQUARE

ADAPTER IMPACT SQUARE

RD

• [BG] Адаптер ударен квадрат • [RO] Adaptor Impact patrat



ART.NO.	BARCODE	SIZE
158905	3800972038028	1/2" F TO HEX 1/4" F
158906	3800972038035	3/8" F TO HEX 1/4" F

SCREWDRIVER BITS 15 PCS. SET

RD

• [BG] Накрайници и магнитен държач бърз захват
• [RO] Set biti si suport magnetic



- pcs Sizing
25mm(L) BIT
- 14
- 3PC SLOTTED: 4, 5, 6
 - ⊕ 2PC PHILLIPS: PH1, PH2
 - ⊗ 2PC POZI: PZ1, PZ2
 - ⊙ 3PC HEX: 3, 4, 5
 - ⊛ 4PC T10, T15, T20, T30
- 1 ADAPTOR MAGNET QUICK RELEASE

ART.NO.	BARCODE	SIZE
158903	3800123171703	1/4"



SCREWDRIVER BITS 32 PCS. SET

RD

• [BG] Накрайници и магнитен държач бърз захват • [RO] Set biti si suport magnetic



- pcs Sizing
25mm(L) BIT
- 30
- 4PCS SLOTTED: 3, 4, 5, 6
 - ⊕ 4PCS PHILLIPS: PH1, PH2, PH3, PH4
 - ⊗ 4PCS POZI: PZ1, PZ2, PZ2, PZ3
 - ⊙ 4PCS HEX: 3, 4, 5, 6mm
 - ⊛ 7PCS T10, T15, T20, T25, T27, T30, T40
 - ⊛ 7PCS: T10, T15, T20, T25, T27, T30, T40
- 1 ADAPTOR 25MM FROM 1/4" TO 1/4 SQR.
- 1 ADAPTOR MAGNET QUICK RELEASE

ART.NO.	BARCODE
158901	3800123171680



SCREWDRIVER BITS 42 PCS. SET

RD

• [BG] Накрайници и магнитен държач бърз захват • [RO] Set biti si suport magnetic

- pcs Sizing
- 25mm(L) BIT
 - 36 SLOTTED: 4 X 2PCS, 5, 6
 - PHILLIPS: PH1, PH2, PH3 X 3PCS
 - POZI: PZ1, PZ2, PZ3 X 4PCS
 - 3PCS HEX: 3, 4, 5
 - 7PCS T10, T15, T20, T25, T27, T30, T40
 - 7PCS: T10, T15, T20, T25, T27, T30, T40
 - 4 75mm BIT: Sl: 6, PH2, Pozl: PZ2, Torx: T25
 - 1 ADAPTOR 25MM FROM 1/4" TO 1/4 SQR.
 - 1 ADAPTOR MAGNET QUICK RELEASE

42 pcs 1/4"



ART.NO. 158902
BARCODE 3800123171697

SCREWDRIVER BITS 1/4" 29 PCS. SET

RD

• [BG] Накрайници комплект • [RO] Set biti si suport magnetic

- pcs Sizing
- 24 5PC SLOTTED: 3, 4, 5, 6, 7 mm
 - 3PC PHILLIPS: PH1, PH2, PH3
 - 3PC POZI: PZ1, PZ2, PZ3
 - 4PC METRIC HEX: H3, H4, H5, H6
 - 3PC SQUARE: #1, #2, #3
 - 6PC STAR: T10, T15, T20, T25, T27, T30
 - 2 50 mm SCREWDRIVER BIT
 - 1 80 mm Long COMPACT SCREW GUIDE
 - 2 6.8 mm MAGNETIC NUT SETTER:

29 pcs 1/4"



ART.NO. 157792
BARCODE 3800123169571

SCREWDRIVER BITS 37 PCS. SET

RD

• [BG] Накрайници комплект • [RO] Set biti si suport magnetic

- pcs Sizing
- 8 2PC SLOTTED: 5.5, 8 mm
 - 3PC PHILLIPS: PH1, PH2, PH3
 - 3PC POZI: PZ1, PZ2, PZ3
 - 5PC SLOTTED: 3, 4, 5, 6, 7mm
 - 3PC PHILLIPS: PH1, PH2, PH3
 - 3PC POZI: PZ1, PZ2, PZ3
 - 24 4PC METRIC HEX: H3, H4, H5, H6
 - 3PC SQUARE: #1, #2, #3
 - 6PC STAR: T10, T15, T20, T25, T27, T30
 - 4 NUT DRIVER 5, 6, 8, 10 mm
 - 1 BIT HOLDER

37 pcs 1/4"



ART.NO. 157793
BARCODE 3800123169588

SCREWDRIVER BITS & DRILL BITS HEX 1/4" 15 PCS. SET

RD

• [BG] Накрайници и свредла • [RO] Set biti si burghie pt. surubelnita 15 pcs

- pcs Sizing
- 7 Ø1.5, 2.0, 3.0, 4.0, 4.5, 5.0, 6.0 mm HSS DRILL BITS WITH HEX SHANK 50mm (L) BIT
 - 7 2PC SLOTTED: 4, 5 mm
 - 2PC PHILLIPS: PH2 x 2
 - 2PC POZI: PZ2 x 2
 - 1PC SQUARE: #2
 - 1 58 mm MAGNETIC HOLDER

15 pcs 1/4" HEX



ART.NO. 157795
BARCODE 3800123169601

SCREWDRIVER BITS & DRILL BITS HEX 1/4" 20 PCS. SET

RD

• [BG] Накрайници и свредла • [RO] Set biti si burghie pt. surubelnita 20 pcs

20 pcs 1/4" HEX

- pcs Sizing
- 7 Ø1.5, 2.0, 3.0, 4.0, 4.5, 5.0, 6.0 mm HSS DRILL BITS WITH HEX SHANK 50mm (L) BIT
 - 9 3PC SLOTTED: 4, 5, 6 mm
 - 3PC PHILLIPS: PH1, PH2, PH3
 - 3PC POZI: PZ1, PZ2, PZ3
 - 3 6, 8, 10 mm NUT DRIVER
 - 1 QUICK CHANGER



ART.NO. 157797
BARCODE 3800123169625

SCREWDRIVER BITS & DRILL BITS S2 HEX 1/4" 42 PCS. SET

RD

• [BG] Накрайници и свредла • [RO] Set 42 biti si burghie S2 HEX

42 pcs 1/4" HEX



ART.NO. 157806
BARCODE 3800972049338
SIZE S2 HEX 1/4"

DRILL STAND

RD

• [BG] Стойка за бормашина • [RO] Suport bormasina

300
mm



ART.NO. BARCODE
139201 3800972004054

ANGLE GRINDER STAND

RD

• [BG] Стойка за ъглошлайф • [RO] Stand cu masa pentru polizor unghiular

115
mm



ART.NO. BARCODE
139912 3800123126208

ANGLE GRINDER STAND

RD

• [BG] Стойка за ъглошлайф • [RO] Stand cu masa pentru polizor unghiular

115
mm

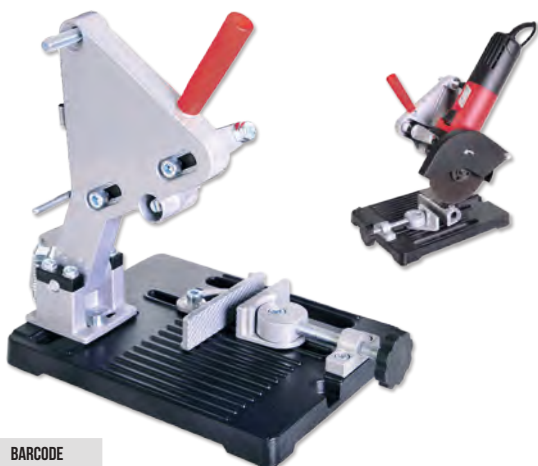

ART.NO. BARCODE
139501 3800972004061

STAND FOR 2 ANGLE GRINDERS

RD

• [BG] Стойка за 2 ъглошлайфа за стена
• [RO] Stand pentru doua polizoare unghiulare



ART.NO. BARCODE
139505 3800972036208

ANGLE GRINDER STAND

RD

• [BG] Стойка за ъглошлайф • [RO] Stand cu masa pt. flex

230
mm



ART.NO. BARCODE
139913 3800123126215

UNIVERSAL CLAMPING WORKBENCH

RD

• [BG] Маса работна-менгеме • [RO] Banc de lucru



ART.NO. BARCODE
139905 3800123119170

HEIGHT ADJUSTABLE UNIVERSAL CLAMPING WORKBENCH

RD

• [BG] Маса работна-менгеме • [RO] Banc de lucru reglabil



ART.NO.	BARCODE
139970	3800123171758

DRILL STAND VICE

RD

• [BG] Менгеме машинно • [RO] Mengina ptr bormasina

75 mm	100 mm
----------	-----------



ART.NO.	BARCODE	SIZE
139914	3800123119132	75 mm
139915	3800123119149	100 mm

QUICK RELEASE BIT HOLDER HEX

RD

• [BG] Държач за битове HEX Quick-Release
• [RO] Suport pentru biți HEX Quick-Release



ART.NO.	BARCODE	SIZE
159955	3800972049598	HEX 1/4" x 60 mm

ANGLE ADAPTER HEX 1/4"

RD

• [BG] Приставка за винтоверт ъглова
• [RO] Adaptor la unghi hexagonal de impact



ART.NO.	BARCODE	SIZE
159917	3800972029200	HEX 1/4"

ANGLE ADAPTER HEX 1/4" LONG

RD

• [BG] Приставка за винтоверт ъглова
• [RO] Adaptor la unghi hexagonal de impact



ART.NO.	BARCODE	SIZE
159918	3800972038011	HEX 1/4" LONG

ANGLE ADAPTER HEX 1/4" IMPACT

RD

• [BG] Приставка за винтоверт ъглова
• [RO] Adaptor la unghi hexagonal de impact



ART.NO.	BARCODE	SIZE
159919	3800972039537	HEX 1/4" IMPACT

ADAPTER SDS-PLUS TO CHUCK 1/2"

RD

• [BG] Адаптер SDS-plus за патронник • [RO] Adaptor mandrina



ART.NO.	BARCODE	SIZE
159901	3800123125607	1/2" 13 mm

METAL KEYLESS CHUCK HEX SHANK 1/4" 8 MM

RD

• [BG] Патронник за винтоверт • [RO] Mandrina pentru surubelnita

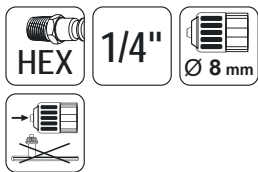

ART.NO.	BARCODE	SIZE
139973	3800972029217	HEX 1/4" 8 mm

DRILL CHUCK

RD

• [BG] Патронник за бормашина • [RO] Mandrina

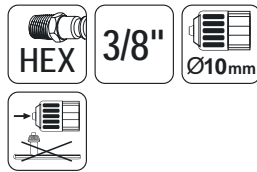

KEYLESS

ART.NO.	BARCODE	SIZE
139003	3800123163814	3/8" 10 mm WITH 1/4" ADAPTER

DRILL CHUCK WITH CHUCK KEY & SDS-PLUS CHUCK ADAPTER KIT

RD

• [BG] Патронник за бормашина • [RO] Mandrina

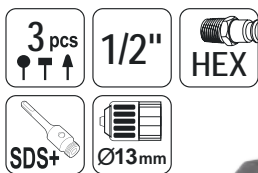

ART.NO.	BARCODE	SIZE
999902	3800123123627	1/2" 13 mm

DRILL CHUCK KEYLESS 2 METAL SLEEVE SDS-PLUS HEX-1/4" M SQUARE 1/2" F

RD

• [BG] Патронник за бормашина • [RO] Mandrina



KEYLESS

ART.NO.	BARCODE	SIZE
999903	3800972038042	1/2" 13 mm HEX 1/4" M SQUARE 1/2" F

DRILL CHUCK

RD-KC01

• [BG] Патронник за бормашина • [RO] Mandrina

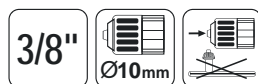

KEYLESS



ART.NO.	BARCODE	SIZE
139906	3800123123931	3/8" 10 mm

DRILL CHUCK

RD-KC02

• [BG] Патронник за бормашина • [RO] Mandrina



KEYLESS



ART.NO.	BARCODE	SIZE
139908	3800123123948	1/2" 13 mm

DRILL CHUCK WITH KEY

RD-KC14

• [BG] Патронник за бормашина • [RO] Mandrina



ART.NO.	BARCODE	SIZE
139002	3800123162862	1/2" 13 mm

DRILL CHUCK WITH KEY

RD-KC03

• [BG] Патронник за бормашина • [RO] Mandrina



ART.NO.	BARCODE	SIZE
139907	3800123126253	1/2" 13 mm

DRILL CHUCK WITH KEY

RD-KC13

• [BG] Патронник за бормашина • [RO] Mandrina cu cheie



ART.NO.	BARCODE	SIZE
139001	3800123162138	1/2" 16 mm

DRILL CHUCK KEYLESS FRONT SLEEVE PLASTIC, REAR SLEEVE METAL

RD-KC12

• [BG] Патронник за бормашина • [RO] Mandrina



KEYLESS



ART.NO.	BARCODE	SIZE
139943	3800123150203	1/2" 13 mm

DRILL CHUCK KEYLESS 2 METAL SLEEVE WITH CLICK

RD-KC11

• [BG] Патронник за бормашина • [RO] Mandrina



KEYLESS



ART.NO.	BARCODE	SIZE
139942	3800123149870	1/2" 13 mm

DRILL CHUCK KEYLESS METAL SLEEVE

RD-MKC12

• [BG] Патронник за бормашина • [RO] Mandrina



KEYLESS



ART.NO.	BARCODE	SIZE
999904	3800972038059	3/8" 10 mm

DRILL CHUCK KEYLESS METAL SLEEVE

RD-MKC13

• [BG] Патронник за бормашина • [RO] Mandrina



KEYLESS



ART.NO.	BARCODE	SIZE
999908	3800972038066	1/2" 13 mm

DRILL CHUCK CONE WITH KEY

RD-KC04

• [BG] Патронник за бормашина конус с ключ • [RO] Mandrina cu cheie



ART.NO.	BARCODE	SIZE
139921	3800123124792	Ø16 mm, 13 mm

DRILL CHUCK CONE WITH KEY

RD-KC05

• [BG] Патронник за бормашина конус с ключ • [RO] Mandrina cu cheie



ART.NO.	BARCODE	SIZE
139922	3800123124808	Ø16 mm, 16 mm

DRILL CHUCK CONE WITH KEY

RD-KC06

• [BG] Патронник за бормашина конус с ключ • [RO] Mandrina cu cheie

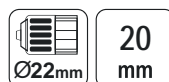

ART.NO.	BARCODE	SIZE
139925	3800123124730	Ø22 mm, 20 mm

CHUCK KEY FOR DRILL CHUCK

RD-KC08

• [BG] Ключ за патронник на бормашина • [RO] Cheie mandrina



ART.NO.	BARCODE	SIZE
139903	3800123126260	13 mm

CHUCK KEY FOR DRILL CHUCK

RD-KC15

• [BG] Ключ за патронник на бормашина • [RO] Cheie mandrina



ART.NO.	BARCODE	SIZE
139004	3800972014329	16 mm

PAINT MIXING PADDLE

RD

• [BG] Бъркалка за боя • [RO] Mixer vopsea

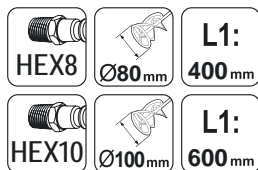

ART.NO.	BARCODE	SIZE
329901	3800123126239	Ø80x400xHEX 8 mm
329902	3800123126246	Ø100x600xHEX 10 mm

MIXING PADDLE

RD

• [BG] Бъркалка • [RO] Mixer vopsea

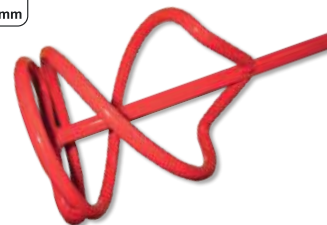
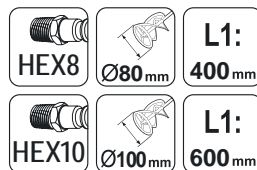

ART.NO.	BARCODE	SIZE
329925	3800123127793	Ø80x400xHEX 8 mm
329926	3800123127809	Ø100x600xHEX 10 mm

MIXING PADDLE WITH FLAT SPIRAL

RD

• [BG] Бъркалка с плоска спирала • [RO] Mixer vopsea

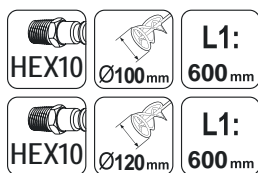

ART.NO.	BARCODE	SIZE
329927	3800123127816	Ø100x600xHEX 10 mm
329928	3800123127823	Ø120x600xHEX 10 mm

MIXING PADDLE SDS-PLUS

RD

• [BG] Бъркалка SDS-plus • [RO] Mixer vopsea

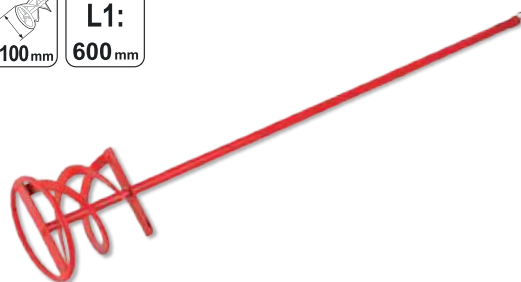
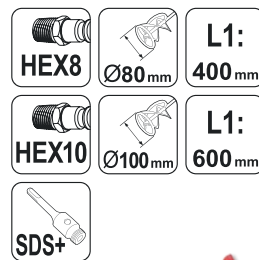

ART.NO.	BARCODE	SIZE
329935	3800123151224	Ø80x400 mm
329936	3800123151231	Ø100x600 mm

MIXING PADDLE FOR POWER MIXER

RD

• [BG] Бъркалка за електрически миксер • [RO] Mixer vopsea



ART.NO.	BARCODE	SIZE
329924	3800123127786	Ø120x600xM14

PAINT MIXING PADDLE HEX

RD

• [BG] Бъркалка поцинкована • [RO] Mixer vopsea

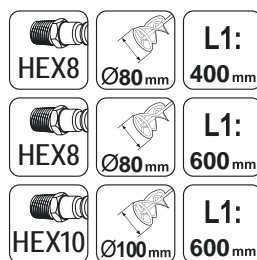

ART.NO.	BARCODE	SIZE
138501	3800123166297	Ø80x400xHEX 8 mm
138502	3800123166303	Ø80x400xHEX 8 mm
138503	3800123166310	Ø100x600xHEX 10 mm

MIXING PADDLE ZINC PLATED SDS-PLUS

RD

• [BG] Бъркалка поцинкована SDS-plus • [RO] Mixer vopsea SDS-plus

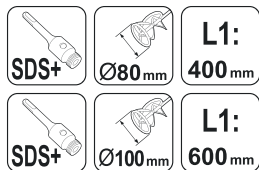

ART.NO.	BARCODE	SIZE
138504	3800123166327	Ø80x400 mm
138505	3800123166334	Ø100x600 mm



MIXING PADDLE ZINC PLATED FOR POWER MIXER

RD

• [BG] Бъркалка поцинкована за електрически миксер
• [RO] Mixer material ZINCAT



ART.NO.	BARCODE	SIZE
138506	3800123166341	Ø120x600xM14

MIXING PADDLE 2 PGS. SET

RD

• [BG] Бъркалки поцинковани комплект • [RO] SET 2 buc Mixer vopsea

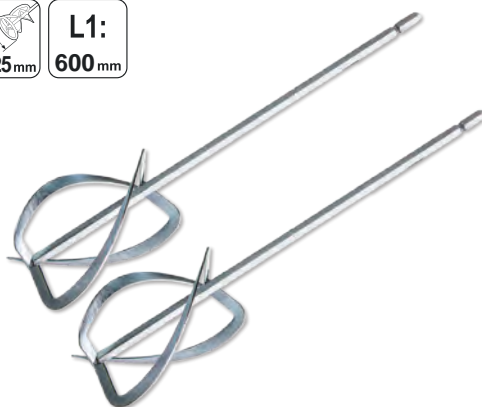

ART.NO.	BARCODE	SIZE
138507	3800972012615	Ø125x600xHEX 13 mm

RUBBER BACKING DISK VELCRO UNIVERSAL

RD

• [BG] Диск Velcro универсален • [RO] Suport cauciuc

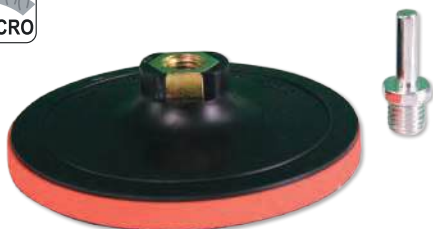
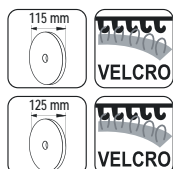

ART.NO.	BARCODE	SIZE
139971	3800972002241	Ø115 mm
139972	3800972002258	Ø125 mm

RUBBER BACKING DISK

RD

• [BG] Диск гумен за ъглошлайф • [RO] Suport circular cauciuc



ART.NO.	BARCODE	SIZE
139920	3800123135781	Ø180 mm

RUBBER BACKING DISK VELCRO FOR ANGLE GRINDER

RD

• [BG] Диск гумен за ъглошлайф • [RO] Suport circular cauciuc



ART.NO.	BARCODE	SIZE
139924	3800123126062	Ø180 mm

LAMBSWOOL POLISHING BONNET FOR POLISHER

RD

• [BG] Кече за полирмашина • [RO] Rezerva lana



ART.NO.	BARCODE	SIZE
209934	3800123150692	Ø125 mm
209935	3800123150708	Ø180 mm
209914	3800123107313	Ø240 mm

POLISHING SPONGE

RD

• [BG] Гъба за полиране • [RO] Burete polish



ART.NO.	BARCODE	SIZE
155801	3800972016620	Ø180 mm

POLISHING KIT

RD

• [BG] Комплект за пастиране
• [RO] Set 3 piese pentru polish



ART.NO.	BARCODE
499976	3800123150715

COMBINATION SHAPE STONE

RD

• [BG] Брус комбиниран • [RO] Piatra pentru ascutit cutite dreptunghiulara alba



ART.NO.	BARCODE	SIZE
499958	3800123136382	200x50x25 mm

COMBINATION SHAPE STONE

RD

• [BG] Брус комбиниран • [RO] Piatra pentru ascutit cutite dreptunghiulara alba



ART.NO.	BARCODE	SIZE
499959	3800123136399	200x50x25 mm

FLAT TAPERED SCYTHE STONE

RD

• [BG] Брус овален
• [RO] Piatra pentru ascutit coasa

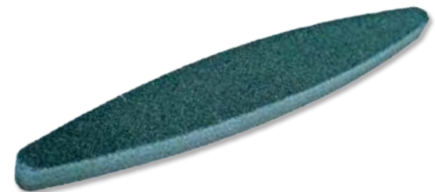

ART.NO.	BARCODE	SIZE
499961	3800123136412	225 mm

SANDING BLOCK

RD

• [BG] Шлайф ръчен • [RO] Suport smirghel



ART.NO.	BARCODE	SIZE
499986	3800123157059	164x80 mm
499902	3800123135095	210x100 mm

SANDING BLOCK WITH HANDLE

RD

• [BG] Шлайф ръчен с дръжка • [RO] Suport smirghel



ART.NO.	BARCODE	SIZE
499901	3800123135101	180x90 mm

TRIMMER LINE ROUND

RD

• [BG] Корда кръгла • [RO] Fir rotund pt trimmer



ART.NO.	BARCODE	SIZE	COLOR
110208	3800123151811	Ø1.3 mm x 15 m	WHITE
110210	3800123151859	Ø1.65 mm x 15 m	YELLOW
110204	3800123141706	Ø2.40 mm x 15 m	ORANGE
110227	3800123166372	Ø3.0 mm x 15 m	DARK RED

TRIMMER LINE SQUARE

RD

• [BG] Корда квадратна • [RO] Fir patrat pt trimmer



ART.NO.	BARCODE	SIZE	COLOR
110209	3800123151828	1.3 mm x 15 m	WHITE
110211	3800123151835	1.65 mm x 15 m	YELLOW
110212	3800123151842	2.40 mm x 15 m	ORANGE
110226	3800123166365	3.0 mm x 15 m	DARK RED

FORCE STRING TRIMMER LINE SQUARE TRANSPARENT

RD

• [BG] Корда квадратна усиlena • [RO] Fir patrat pt trimmer



ART.NO.	BARCODE	SIZE
110280	3800972003880	1.65 mm x 15 m
110281	3800972003897	2.00 mm x 15 m
110235	3800123167409	2.40 mm x 15 m
110237	3800972029606	2.70 mm x 15 m
110282	3800972003903	3.0 mm x 15 m
110283	3800972003910	3.50 mm x 15 m
110285	3800972004269	4.0 mm x 15 m
110286	3800972004276	4.5 mm x 15 m

FORCE STRING TRIMMER LINE SQUARE TWISTED TRANSPARENT

RD

• [BG] Корда квадратна усиlena усукана • [RO] Fir patrat rasucit pt trimmer



ART.NO.	BARCODE	SIZE
110309	3800972029613	2.00 mm x 15 m
110310	3800972029620	2.40 mm x 15 m
110311	3800972029637	2.70 mm x 15 m
110312	3800972029644	3.00 mm x 15 m
110313	3800972029651	3.50 mm x 15 m
110314	3800972029668	4.00 mm x 15 m

FORCE STRING TRIMMER LINE SQUARE TWISTED TRANSPARENT

RD

• [BG] Корда квадратна усиlena усукана • [RO] Fir patrat rasucit pt trimmer



ART.NO.	BARCODE	SIZE
110236	3800123167416	2.40 mm x 260 m

FORCE STRING TRIMMER LINE SQUARE PLATIN-SILVER

RD

• [BG] Корда квадратна усиlena Platin-silver • [RO] Fir patrat rasucit pt trimmer



ART.NO.	BARCODE	SIZE
110290	3800972015807	2.70 mm x 15 m
110291	3800972015814	3.00 mm x 12 m

STRING TRIMMER LINE STAR RED

RD

• [BG] Корда звезда • [RO] Fir stea pentru motocoasa



ART.NO.	BARCODE	SIZE
110315	3800972029675	2.00 mm x 15 m
110316	3800972029682	2.40 mm x 15 m
110317	3800972029699	2.70 mm x 15 m
110318	3800972029705	3.00 mm x 15 m
110319	3800972029712	3.50 mm x 15 m
110320	3800972029729	4.00 mm x 15 m

STRING TRIMMER LINE SAW TEETH BLACK

RD

• [BG] Корда двоен трион • [RO] Fir zimtat pentru motocoasa



ART.NO.	BARCODE	SIZE
110321	3800972029736	3.00 mm x 15 m
110322	3800972029743	3.50 mm x 15 m
110323	3800972029750	4.00 mm x 15 m

TRIMMER LINE TWISTED BLACK

RD

• [BG] Корда безшумна • [RO] Trimmer Line Twisted



ART.NO.	BARCODE	SIZE
110248	3800123172090	Ø3.00 mm x 28 m
110249	3800123172106	Ø3.30 mm x 46 m
110250	3800123172113	Ø4.00 mm x 32 m
110251	3800123172120	Ø4.50 mm x 25 m
110363	3800972031562	Ø4.80 mm x 20 m

TRIMMER HEAD

RD

• [BG] Корда с тримерна глава • [RO] Trimmer Head



ART.NO.	BARCODE	SIZE
110207	3800123143526	Ø2.40 mm x 3 m M10x1.25LH

EASY LOAD TAP & GO TRIMMER HEAD

RD

• [BG] Корда с тримерна глава с лесно навиване • [RO] Mosor cu fir pentru motocoasa

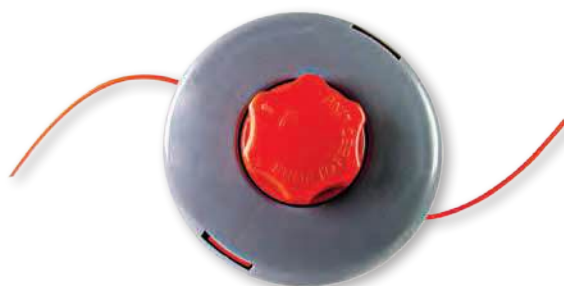

ART.NO.	BARCODE	SIZE
110333	3800972030466	Ø2.40 mm x 3 m M10x1.25LH

EASY LOAD TAP & GO TRIMMER HEAD

RD

• [BG] Корда с глава лесно навиване • [RO] Mosor cu fir pentru motocoasa



ART.NO.	BARCODE	SIZE
110334	3800972030473	Ø2.40 mm x 3 m M10x1.25LH

EASY LOAD TAP & GO TRIMMER HEAD

RD

- [BG] Корда с глава с лесно навиване за моторна коса
- [RO] Mosor cu fir pentru motocoasa



ART.NO.	BARCODE	SIZE
110234	3800123167638	M10x1.25LH

TRIMMER HEAD

RD

- [BG] Корда с тримерна глава универсална за моторна коса
- [RO] Mosor cu fir pentru motocoasa



ART.NO.	BARCODE	SIZE
110228	3800123166389	Ø2.40 mm x 3 m

EASY LOAD TAP & GO TRIMMER HEAD

RD

- [BG] Корда с глава лесно навиване • [RO] Mosor cu fir pentru motocoasa



ART.NO.	BARCODE	SIZE
110335	3800972030480	Ø2.40 mm M10x1.25LH

EASY LOAD TAP & GO TRIMMER HEAD

RD

- [BG] Корда с глава лесно навиване • [RO] Mosor cu fir pentru motocoasa



ART.NO.	BARCODE	SIZE
110336	3800972030497	2.40 mm x 10 m

EASY LOAD TAP & GO TRIMMER HEAD

RD

- [BG] Корда с глава лесно навиване • [RO] Mosor cu fir pentru motocoasa



ART.NO.	BARCODE	SIZE
110337	3800972030503	M10x1.25LH

EASY LOAD TAP & GO TRIMMER HEAD

RD

- [BG] Корда с глава лесно навиване • [RO] Mosor cu fir pentru motocoasa



ART.NO.	BARCODE	SIZE
110338	3800972030510	M10x1.25LH

EASY LOAD TAP & GO TRIMMER HEAD

RD

• [BG] Корда с глава лесно навиване • [RO] Mosor cu fir pentru motocoasa



ART.NO.	BARCODE	SIZE
110346	3800972031159	M10x1.25LH

EASY LOAD TAP & GO TRIMMER HEAD

RD

• [BG] Корда с глава лесно навиване • [RO] Mosor cu fir pentru motocoasa



ART.NO.	BARCODE	SIZE
110347	3800972031166	4 M10x1.25LH

TRIMMER HEAD

RD

• [BG] Корда с глава лесно навиване • [RO] Cap de motocoasa



ART.NO.	BARCODE	SIZE
110348	3800972031173	Ø2.40 mm M10x1.25LH PA

EASY LOAD TAP & GO TRIMMER HEAD

RD

• [BG] Корда с глава лесно навиване • [RO] Mosor cu fir pentru motocoasa



ART.NO.	BARCODE	SIZE
110349	3800972031180	Ø1.25 mm M10x1.25LH PA

EASY LOAD TAP & GO TRIMMER HEAD

RD

• [BG] Корда с глава лесно навиване • [RO] Mosor cu fir pentru motocoasa



AL



ART.NO.	BARCODE
110340	3800972030534

EASY LOAD TAP & GO TRIMMER HEAD

RD

• [BG] Корда с глава лесно навиване • [RO] Mosor cu fir pentru motocoasa



AL

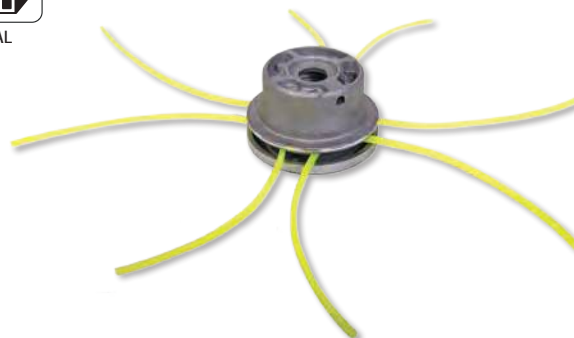

ART.NO.	BARCODE
110262	3800123174667

BLADE FOR BRUSH CUTTER 3 TEETH

RD

• [BG] Нож за коса • [RO] Lama motocoasa tip triunghi



3
teeth



ART.NO.	BARCODE	SIZE
142101	3800123158629	Ø255x25.4 mm

BLADE FOR BRUSH CUTTER 4 TEETH

RD

• [BG] Нож за коса • [RO] Lama motocoasa tip triunghi



4
teeth



ART.NO.	BARCODE	SIZE
110229	3800123166396	Ø255x25.4 mm

BLADE FOR BRUSH CUTTER TCT 40 TEETH

RD

• [BG] Диск за коса • [RO] Lama motocoasa tip triunghi



40
teeth



ART.NO.	BARCODE	SIZE
110230	3800123166402	Ø255x25.4 mm

BLADE FOR BRUSH CUTTER 80 TEETH

RD

• [BG] Диск за коса • [RO] Lama motocoasa tip triunghi



80
teeth



ART.NO.	BARCODE	SIZE
110240	3800972024335	Ø255x25.4 mm

BLADE FOR BRUSH CUTTER DOUBLE TCT 40 TEETH

RD

• [BG] Диск за коса • [RO] Lama motocoasa tip triunghi



40
teeth



ART.NO.	BARCODE	SIZE
110343	3800972030565	Ø255x25.4 mm

BLADE FOR BRUSH CUTTER

RD

• [BG] Диск за коса • [RO] Lama motocoasa tip triunghi



20
teeth



ART.NO.	BARCODE
110344	3800972030572

TWIST KNOT WIRE BEVEL BRUSH FOR BRUSH CUTTER

RD

• [BG] Четка за коса конусна плетена • [RO] Lama motocoasa tip perie de sarma

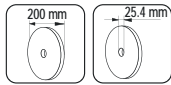

ART.NO.	BARCODE	SIZE
110241	3800972026315	Ø200x25.4 mm

BLADE FOR BRUSH CUTTER 40TCT & WEEDER 3T

RD

• [BG] Диск за коса • [RO] Lama motocoasa disc



ART.NO.	BARCODE	SIZE
110364	3800972032101	Ø255x25.4 mm

WEEDER PLATE

RD

• [BG] Диск за плевели • [RO] Lama motocoasa tip freza de buruieni



ART.NO.	BARCODE	SIZE
110341	3800972030541	Ø150 mm

PADDY HARVESTER FOR BRUSH CUTTERS

RD

• [BG] Приставка за косене на висока коса
• [RO] Dispozitiv recoltare cereale pentru motocoasa



ART.NO.	BARCODE
110342	3800972030558

HARNESS SOFT PADDING SINGLE BELT

RD

• [BG] Самар за коса единичен
• [RO] Ham barete pt motocoasa cu protectie la umar



ART.NO.	BARCODE
110326	3800972030398

HARNESS WITH SHOULDER STRAPS & SOFT PADDING

RD

• [BG] Самар за коса с меки презраменни колани червен
• [RO] Ham barete pt motocoasa cu protectie la umar



ART.NO.	BARCODE
110284	3800972003927

HARNESS WITH SHOULDER STRAPS & SOFT PADDING RED

RD

- [BG] Самар за коса с меки презраменни колани червен
- [RO] Ham barete pt motocoasa cu protectie la umar



ART.NO.	BARCODE
110327	3800972030404

HARNESS WITH SHOULDER STRAPS & SOFT PADDING BLACK

RD

- [BG] Самар за коса с меки колани черен
- [RO] Ham barete pt motocoasa cu protectie la umar



ART.NO.	BARCODE
110328	3800972030411

HARNESS WIDE SHOULDER STRAPS & SOFT PADDING BLACK

RD

- [BG] Самар за коса с широки и меки колани черен
- [RO] Ham barete pt motocoasa cu protectie la umar



ART.NO.	BARCODE
110329	3800972030428

HARNESS WIDE SHOULDER STRAPS & SOFT PADDING RED

RD

- [BG] Самар за коса с широки и меки колани червен
- [RO] Ham barete pt motocoasa cu protectie la umar



ART.NO.	BARCODE
110330	3800972030435

HARNESS WIDE SHOULDER STRAPS & SOFT PADDING

RD

- [BG] Самар за коса с широки и меки колани черен с червен кант
- [RO] Ham barete pt motocoasa cu protectie la umar



ART.NO.	BARCODE
110331	3800972030442

HARNESS WIDE SHOULDER STRAPS & SOFT PADDING ANTIVIBRATION

RD

- [BG] Самар за коса с широки и меки колани антивибрационен
- [RO] Ham barete pt motocoasa cu protectie la umar



ART.NO.	BARCODE
110332	3800972030459

PETROL AND OIL HAND SUCTION PUMP

RD

• [BG] Помпа ръчна за масло и гориво • [RO] Pompa manuala

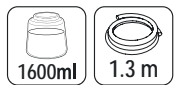

1600ml

1.3 m



Ø 6 mm

Ø 8 mm



ART.NO.	BARCODE
075907	3800972024618

ENGINE OIL SAE30 1L RAIDER

RD

• [BG] Масло SAE30 • [RO] Ulei RAIDER SAE30 pentru motoare in 4 timpi 1L



1000ml



ART.NO.	BARCODE
075906	3800972005105

GEAR OIL EP90 1L RAIDER

RD

• [BG] Масло трансмисионно EP90 • [RO] Ulei transmisie 80W90 1L



1000ml



ART.NO.	BARCODE
075902	3800123172069

TWO STROKE OIL 1L RAIDER

RD

• [BG] Масло за двутактови двигатели
• [RO] Ulei pentru motoare in doi timpi 1L RAIDER



1000ml



ART.NO.	BARCODE
075903	3800123172076

TWO STROKE SEMI SYNTHETIC LOW SMOKE OIL 1L RAIDER

RD

• [BG] Масло за двутактови двигатели полусинтетично бездимно
• [RO] Ulei pentru motoare in doi timpi semisintetic 1L RAIDER



1000ml



ART.NO.	BARCODE
075905	3800972002487



ROLLING TOOL BOX WITH COLLAPSIBLE HANDLE

RDP-MSS1

• [BG] Куфар за инструменти с колела сгъваема дръжка • [RO] Cutie scule

IP65



ART.NO.	BARCODE	SIZE
139605	3800972037854	560x480x380(645) mm

ROLLING TOOL BOX

RDP-MSS2

• [BG] Куфар • [RO] Cutie scule

IP65



ART.NO.	BARCODE	SIZE
139606	3800972037861	556x424x251 mm

TOOL BOX

RDP-MSS3

• [BG] Куфар • [RO] Cutie scule

IP65



ART.NO.	BARCODE	SIZE
139607	3800972037878	556x424x131 mm

TOOL BOX

RDP-MSS4

• [BG] Куфар • [RO] Cutie scule

IP65



ART.NO.	BARCODE	SIZE
139608	3800972037885	420x278x231 mm

TOOL BOX TRANSPARENT LID

RDP-MSS5

• [BG] Куфар прозрачен капак • [RO] Cutie scule

IP65



ART.NO.	BARCODE	SIZE
139609	3800972037892	420x278x131 mm

TOOL BOX

RDP-MSS6

• [BG] Куфар • [RO] Cutie scule

IP65



ART.NO.	BARCODE	SIZE
139616	3800972038349	420x278x131 mm

RAIDER®

MODULAR STORAGE SYSTEM

RDP-MSS7

- [BG] Модулна система с колела
- [RO] Sistem depozitare modula

ART.NO.	BARCODE
139615	3800972037908



TOOL BAG 18"

RD

• [BG] Чанта за инструменти • [RO] Geanta cu scule

18"



ART.NO.	BARCODE
499941	3800972012479

ROLLING RIGID TOOL

RDP

• [BG] Чанта за инструменти телескопична дръжка колела
• [RO] Cutie rigidă pe roți

20"



19
pockets

MAX LOAD
20kg



ART.NO.	BARCODE
139617	3800972042193

UNIVERSAL DRILL HOLSTER

RD

• [BG] Кобур за винтоверт и аксесоари
• [RO] Suport universal pentru bormasina



ART.NO.	BARCODE
499966	3800972035034



FILTERING HALF MASK FFP2

RD

• [BG] Маска предпазна FFP2 • [RO] Masca de praf FFP2

FFP2
NR



ART.NO.	BARCODE	PCS
561503	3800972048324	1
561504	3800972048331	3
561505	3800972048348	10

SAFETY GLASSES

RD

• [BG] Очила • [RO] Ochelari de protectie lentila intunecata



ART.NO.	BARCODE
561401	3800972016170

SAFETY HELMET WITH EARMUFFS AND STEEL MESH

RD

- [BG] Каска с антифони и щит с предпазна метална мрежа
- [RO] Set casca de protectie cu viziera si casti antifon

- a Acrylonitrilic butadiene styrene safety Helmet with adjustable six point harness for optimum fit and comfort
- b Adjustable plastic carrier with positive "click stop" flip-up facility
- c Mesh visor to protect face from flying debris
- d High performance ear muffs guard against the excessive noise
- e Spring steel mounting for improved stability whilst in use



ART.NO.	BARCODE
561301	3800972016163

HEARING PROTECTION WITH VISOR

RD

- [BG] Антифони с визьор • [RO] Set vizor si casti cu antifon RD



ART.NO.	BARCODE
561414	3800972026353

SAFETY KNEEPADS

RD

- [BG] Наколенки • [RO] Genunchiere protectie



ART.NO.	BARCODE
560501	3800972025547

IMPACT & CUT RESISTANT GLOVES SIZE 10

RD

- [BG] Ръкавици противоударни противосрезни
- [RO] Manusi rezistente la impact si taiere



ART.NO.	BARCODE
561415	3800972035416

IMPACT & CUT RESISTANT GLOVES VELCRO SIZE 10

RD

- [BG] Ръкавици противоударни противосрезни
- [RO] Manusi rezistente la impact si taiere Velcro



ART.NO.	BARCODE
561416	3800972035423



GLOVES POLYESTER LATEX SIZE 10

RD

- [BG] Ръкавици полиестерни латекс 13G
- [RO] Manusi de protectie Polyester Latex



ART.NO.	BARCODE
561417	3800972045538

GLOVES SPANDEX LATEX SIZE 10

RD

- [BG] Ръкавици Spandex латекс 13G
- [RO] Manusi de protectie Polyester Latex



ART.NO.	BARCODE
561418	3800972045545

HIGH-VIS FUNCTIONAL T-SHIRT ORANGE

RD

- [BG] Тениска сигнална orange
- [RO] Tricou de lucru portocaliu cu benzi reflectorizante



ART.NO.	BARCODE	SIZE
557181	3800972049079	L
557182	3800972049086	XL
557183	3800972049093	XXL
557184	3800972049109	XXXL

HEAVY DUTY WORK SHORTS

RD

- [BG] Работен панталон къс • [RO] Pantaloni scurti de lucru



ART.NO.	BARCODE	SIZE
561419	3800972047839	M
561420	3800972047846	L
561421	3800972047853	XL
561422	3800972047860	XXL
561423	3800972047877	XXXL

POLAR FLEECE JACKET

RD

- [BG] Яке поларено • [RO] Geaca de lucru polar



ART.NO.	BARCODE	SIZE
561429	3800972047938	M
561430	3800972047945	L
561431	3800972047952	XL
561432	3800972047969	XXL
561433	3800972047976	XXXL

SOFTSHELL HOODED JACKET

RD

- [BG] Яке с качулка Softshell • [RO] Geaca soft shell de lucru bleumarin gluga



ART.NO.	BARCODE	SIZE
561424	3800972047884	M
561425	3800972047891	L
561426	3800972047907	XL
561427	3800972047914	XXL
561428	3800972047921	XXXL

WATERPROOF JACKET HIGH-VIS ORANGE

RD

• [BG] Яке водозащитно • [RO] Jacheta impermeabila cu banda reflectiva



ART.NO.	BARCODE	SIZE
561434	3800972047983	XL
561435	3800972047990	XXL

WATERPROOF TROUSERS

RD

• [BG] Панталон водозащитен • [RO] Pantaloni impermeabili



ART.NO.	BARCODE	SIZE
561436	3800972048003	XL
561437	3800972048010	XXL



SAFETY SHOES S1P KEVLAR COMPOSITE

RD

• [BG] Работни обувки • [RO] Gheata cu protectie



ART.NO.	BARCODE	SIZE	561443	3800972048065	43
561439	3800972048027	39	561444	3800972048072	44
561440	3800972048034	40	561445	3800972048089	45
561441	3800972048041	41	561446	3800972048096	46
561442	3800972048058	42	561447	3800972048102	47





































S1P KEVLAR COMPOSITE MID



























RD

































• [BG] Работни обувки • [RO] Gheata cu protectie











































































ART.NO.	BARCODE	SIZE	561452	3800972048157	43
561448	3800972048119	39	561453	3800972048164	44
561449	3800972048126	40	561454	3800972048171	45
561450	3800972048133	41	561455	3800972048188	46
561451	3800972048140	42	561456	3800972048195	47





































 <p>230V~50Hz</p>	<p>Power supply • Захранване • Tensione intrare • Napajanje • Напон • Источник питания • Napetost • Τροφοδοσία • Napajanje • Source de courant • Alimentazione elettrica • Fonte de nutrado • Fonte de energia</p>	 <p>1500 mAh</p>	 <p>LASER</p> <p>Device is equipped with laser indicator • Машината е снабдена с лазерен индикатор • Echipat cu indicator laser • Mašina poseduje laserski indikator • Уредот е опремен со ласерски индикатор • Устройство оснащено индикатором лазерный • Vsebuje laser • Η συσκευή είναι εξοπλισμένη με δείκτη λέιζερ • Laser • L'appareil est équipé d'un indicateur laser • Il dispositivo è dotato di indicatore laser • Aparato estas ekipita per lasera indikilo • O dispositivo está equipado com indicador de laser</p>
 <p>950W</p>	<p>Power • Мощност • Putere • Snaga • Моќност • Питание • Моќ • Εξουσία • Snaga • Puissance • Energia • Potenco • Poder</p>	 <p>LCD DISPLAY</p>	 <p>DUST CAPTURE ΠΡΑΧΟ-ΥΛΙΑΣΗ</p> <p>Dust Capture • Прахуоулавње • Praf de extracție • Усаванье • Прав φακье • Очистка воздуха от пыли • Odsavanje • Αναρρόφηση σκόνης • Za prašinu • Capture de poussière • Cattura della polvere • Kovilo de Polvo • Captura de poeira</p>
 <p>0-1000 min⁻¹</p>	<p>Maximum rotations • Обороти • Nr. maxim rotatii • Maksimalni broj obrtaja • Максимальни вртежи • Максимальные вращения • Στέλινο vrtljajev • Μέγιστος περφορές • Revolucije • Rotations maximales • Rotazioni massime • Maksimumaj rotacijo • Rotações máximas</p>	 <p>0.58 m</p>	 <p>45°</p> <p>Cutting angle adjustment • Рязане под ъгъл • Ajustare unghi laiere • Себенение под углом • Сеенье от агол • Ρεγυλιровка угла резания • Nastavljiv kot rezanja • Κοπή ρύθμιση γωνίας • Kut rezanja • Réglage de l'angle de coupe • Regolazione dell'angolo di taglio • Anglesluga angulo • Ajuste do ângulo de corte</p>
 <p>3.5 kg</p>	<p>Weight • Тегно • Greutate • Težina • Тежина • Масса • Teža • Βάρος • Težina • Poids • Il peso • Peso • Carga</p>	 <p>13mm</p>	 <p>185x20x18T</p> <p>Circular disc dimensions • Размери на диска за циркуляр • Dimensiuni disc • Dimenzije diska • Размер на дискот • Диск размери • Velikosti diska • Διαστάσεις δίσκου • Velčina kružnog diska • Dimensions du disque circulaire • Dimensiuni del disco circular • Cirkularj diskodimensioj • Dimensões do disco circular</p>
 <p>VARIABLE SPEED</p>	<p>Variable speed • Ρεγυλιруеми обороти • Viteza variabila • Ροδεύавание броя обртажа • Варијација на вртежи • Ρεγυλιруема скорост • Nastavljiva hitrost • Ρυθμιζόμενη ταχύτητα • Podesivi brzine • Vitesse variable • Velocität variable • Varia rapido</p>	 <p>26mm</p>	 <p>63 mm (max)</p> <p>Cutting depth in wood • Дълбочина на рязане в дрво • Adancime taiere in lemn • Dubina sečenja kroz drvo • Длабочина на сеченье во дрво • Глубина пропила в дресовине • Globina reza • Βόθος κοπής σε ξύλο • Dubina rezanja u drvu • Profondeur de coupe dans le bois • Profundità di taglio in legno • Tranča profundo em ligno • Profundidade de corte em madeira</p>
 <p>L R</p>	<p>Left - right rotations • Ρεверс • Rotatie stanga-dreapta • Rotacija u oba smjera • Реверс • Реверс • Leva – desna rotacija • Αντίστροφη • Revertzna Rotations gauche - droite • Rotazioni sinistra-destra • Maldekstre-dekstre rotacio • Rotações esquerda-direita</p>	 <p>30mm</p>	 <p>0-3 mm</p> <p>Planning depth • Дълбочина на рендосване • Adancime maxima prelucrare • Dubina renđanja • Длабочина на струганье • Глубина строгания • Настављива глобина утора • Πλάτος πλάνισης • Širina blanjanja • Planifier la largeur maximum • Pianificazione della larghezza massima • Planante maksimuman laržon • Largura máxima de planejamento</p>
 <p>1-16mm</p>	<p>Chuck diameter • Размер патронник • Diametru interior mandrina • Dimenzije glave bušilice • Дијаметар на футер • Диаметр патрона • Velikost glave • Τροφοδοσία • Stezna glava veličina • Diamètre du mandrin • Diametro del mandrino • Chuck-diameter • Diâmetro do mandril</p>	 <p>2.8J</p>	 <p>82 mm</p> <p>Planning maximum width • Макс. ширина на рендосване • Latime maxima prelucrare • Maksimalna širina renđanja • Макс. ширина на струганье • Ширина строгания • Настављива širina • Πλάτος πλάνισης • Širina blanjanja • Planifier la largeur maximum • Pianificazione della larghezza massima • Planante maksimuman laržon • Largura máxima de planejamento</p>
	<p>Impact function • Ударна функција • Functie impact • Udarna funkcija • Ударна функција • Импакт функција • Udarna funkcija • Αετιουργία των επιπτώσεων • Udarce funkcija • Fonction d'impact • Funzione d'impatto • Trafo funkcio • Função de impacto</p>		 <p>8 mm</p> <p>Collet sleeves diameter • Дијаметр на цангата • Diametru mandrina freza electrica • Прећник stezne çaurе • Дијаметар на футер • Цанговий дијаметар • Premer stročnik • Διјаметрос τοοκ • Promjer slezne çahure • Diamètre des manchons • Diametro delle maniche delle pinze • Pinça mankoj diámetro • Diâmetro de mangas</p>
	<p>Keyless chuck • Брзозатаегац патронник • Mandrina rapida • Brzozataezajci dodatak • Брзо затенувачки футер • Быстрозахимный патрон • Hitrovenjalna vrtalna glava • Ταχυτόοκ • Brzostezna glava • Mandrin sans clé • Mandrino senza chiave • Chuck sen šlosilo • Chuck sem chave</p>	 <p>2650 min⁻¹</p>	 <p>0-40 mm</p> <p>Plunge depth • Ход на фрезоващата глава • Afundare maxima • Улаз за glavu frezera • Од на главата на фрезата • Окунитеся глубины • Stroke rezkalna glava • Βόθος βουτίσ • Potezom mljevenja glave • Profondeur de plongée • Profundità di immersione • Profundigu • Profundidade de mergulho</p>
 <p>COLOR BOX</p>	<p>Wrap in color box • Опаковано в цветна кутия • Ambalaj colorat • Ураковано u kutiji u boji • Снакувано во кутия • Обверните в коробе цвета • Zavijte ga u polju barva • Тулите се кути хриџаτος • Pakiranja u kutiji u boji • Enveloppe dans la boîte de couleur • Avvolgi nella scatola dei colori • Envolvijo en kolora skatolo • Embrulham em caixa de cor</p>	 <p>LOCK</p>	 <p>120-380 m/min</p> <p>Belt transport speed • Скорост на лентата • Viteza curea transmisie • Brzina trake • Издржливост на ременот • Скорост протививањия ленти • Hitrost krozelna brusilica • Ταχύτητα ταυίος • Brzina trake • Courroie de transport • Velocität di trasporto della cinghia • Rapido de transporte de zono • Velocidade de transporte da correia</p>
	<p>Case packing • Куфар • Cutie • Ураковано u koferu • Куфер • Чемодан • Zadeva pakiranje • Υπόβαση Συσκευασια • U kofer • Emballage de cas • Imballaggio della cassa • Skatola pakado • Embalagem da caixa</p>	 <p>125 mm</p>	 <p>76x533 mm</p> <p>Belt dimensions • Размери на шкурката за лентос шлайф • Dimensuni curea transmisie • Dimenzija smrgle za trakasto slajfovanje • Големина на шмурплата • Размери ленти • Dimenzija brusnega traku • Зυήση διαστάσεις • Velčina paprom za Tracna brusilica • Dimensions de la ceinture • Dimensiuni della cinghia • Zonoj • Dimensões da correia</p>
 <p>2x GEARS</p>	<p>Gears • Скорости • Pinioane • Zupčanci • Запчаницы • Передачи • Zobniki • Γρανάζια • Brzine • Engrenages • Ingranaggi • Ilaro • Engrenagem</p>	 <p>22.2 mm</p>	 <p>0.58 m</p> <p>Mixing paddle length • Дължина на бъркалката • Lungime paleta mixare • Dužina mešalice • Должина на мешалката • Дължина мешавинице весло • Dolžina mešanje veslo • Ανάμικτη μήκος κούτι • Duljina mješalcom • Longueur de la palette de mélange • Lunghezza della paletta di miscelazione • Miskado de padeloko • Comprimento da pá de mistura</p>





















 <p>CHARGING TIME 1h</p>	<p>Charging time • Време за зареждане на батеријата • Timp de încărcare a bateriei • Vreme punjenja baterije • Време на попуњење на батеријата • Време зарјадки акумулатора • Cas polnjenja baterije • Ο χρόνος φόρτισης της μπαταρίας • Vrijeme punjenja baterija • Temps de charge • Tempo di carica • Tempo de şarjă • O tempo de carga</p>	 <p>115 mm</p> <p>Cutting depth in wood • Дълбочина на рязане в дрво • Adâncime tăiere în lemn • Dubina sečenja kroz drvo • Длабочина на сечење во дрво • Глубина пропила в дрвесини • Globina reza • Βόθος κοπής σε ξύλο • Dubina rezanja u drvu • Profondeur de coupe dans le bois • Profondità di taglio in legno • Trancha profundo en ligno • Profundidade de corte em madeira</p>	 <p>Ø120/140 mm</p> <p>Mixing paddle diameter • Диаметър на бъркалката • Diametru paleta mixare • Пребрник мешалце • Дијаметар на мешалката • Диаметром смешивания вестел • Mešanje veslo premera • Αντιβλήθ διαμέτρο κολλίτ • Promjer mješalicom • Diamètre de la palette de mélange • Diametro della paletta di miscelazione • Miksante diametron • Diâmetro da pá de mistura</p>
 <p>18 V</p>	<p>Voltage • Волтаж • Voltaj • Voltaža • Напон • Напряжение • Napetost • Δυνάμικό • Napon • L'voltage • Voltaggio • Tensio • Voltagem</p>	 <p>90 mm</p> <p>Max cutting depth in metal • Макс. дълбочина на рязане в метал • Adâncime maximă de tăiere în metal • Maksimalna dubina sečenja kroz metal • Максимальна длабочина на сечење во метал • Максимальна глубина резания металов • Največja globina reza v kovino • Μέγιστο βάθος κοπής μετάλλων • Maks. dubina rezanja u metalu • Profondeur de coupe max en métal • Massima profondità di taglio in metallo • Maksimuma trancha profundo en metalo • Profundidade máxima de corte em metal</p>	 <p>0.30 L/min</p> <p>Maximum capacity • Максимален капацитет • Capacitate maxima • Максимальный капацитет • Максимальная емкость • Največji pretok • Η μέγιστη χωρητικότητα • Maksimalni kapacitet • Capacità maximale • Capacità massima • Maksimuma kapacito • Capacidade máxima</p>
 <p>42 Nm</p>	<p>Torque • Въртящ момент • Cuplu maxim • Obrtni moment • Вртежен момент • Крутящий момент • Моќ в Nm • Potnj • Zakretnog momenta • Couple • Momento torcente • Paro • Esforço de torção</p>	 <p>90 mm</p> <p>Max cutting depth in PE / PP • Макс дълбочина на рязане в PE / PP • Adâncime maximă de tăiere în PE / PP • Maks. dubina sečenja kroz PE / PP • Максимальна длабочина на сечење во PE / PP • Максимальна глубина резания PE / PP • Največja globina reza v PE / PP • Μέγιστο βάθος κοπής PE / PP • Maks. dubina rezanja u PE / PP • Profondeur de coupe max en PE / PP • Profondità di taglio massima in PE / PP • Maksimuma trancha profundo en PE / PP • Profundidade máxima de corte em PE / PP</p>	 <p>800ml</p> <p>Container capacity • Обем на контейнера • Capacitate recipient • Каркацитет контејнера • Капацитет на контејнерот • Объем контейнера • Prostornina posode • Όγκος δοχείου • Volumen spremnika • Capacité du conteneur • Capacità del contenitore • Kapacit • Capacidade do recipiente</p>
 <p>16 + 1</p>	<p>Torque control range • Степени на регулиране на въртящия момент • Control putere-cuplu • Степен regulacije unutrašnjeg momenta • Степен на регулација на вртежниот момент • Диапазон управленија моментом • Navora območje • Ροπή εύρος ελέγχου • Stupanj kontrole momenta • Plage de contrôle de couple • Campo di controllo della coppia • Paro kontrolo gamo • Faixa de controle de torque</p>	 <p>24 mm</p> <p>Move of the knife • Ход на ножа • Accident vascular cerebral lama • Hod noža • Потер на мечот • Ход лезвия • Hod rezila • Ευκταρόλη ή λείψο • Pomiscanje nož • Mouvement du couteau • Spostamento del coltello • Movó de la trancilo • Mover da faca</p>	 <p>Ø0.8mm</p> <p>Paint nozzle diameter • Диаметър на лозата за боя • Diametru duza • Пребрник mlaznice за боју • Дијаметар на лозата • Диаметр сопла для краски • Premer šobe za barve • Διαμέτρος πτεκ για βαφή • Promjer mlaznice boja • Diamètre de la buse de peinture • Dipingiti diameter dell'ugello • Pentras cigaredon diameter • Diâmetro do bico de pintura</p>
 <p>Ø125mm</p>	<p>Diameter of abrasive disc • Диаметър на шлифовъчния диск • Diametru disc abraziv • Пребрник diska za šljafovanje • Дијаметар на абразивниот диск • Дијаметр шлифовалног диска • Premer brusilnega diska • Διαμέτρος δίσκου τυχ λειαντικού • Promjer brusa • Diamètre du disque abrasif • Diametro del disco abrasivo • Diametro de abrasia disko • Diâmetro do disco abrasivo</p>	 <p>12.7 mm</p> <p>Disc dimensions • Размери на диска • Dimensiuni disc • Dimenzije diska • Размер на дискот • Диск размери • Velikosti diska • Διαστάσεις δίσκου • Veličina diska • Dimensions du disque • Dimensioni del disco • Dimensioj diskoj • Dimensões do disco</p>	 <p>150 mm</p> <p>Base dimensions of finishing sander • Размери на шкурката • Dimensiunile bazei de slefuire • Dimenzije šmirgle • Дијаметар на базата на шпалферката • Базови размери отделочных шлифовальных • Основна dimenzija brusnega papirja • Διαστάσεις βάσης τριβής φινιρίσματος • Veličina brusni papirni • Dimensions de base de la ponceuse de finition • Dimensioni di base della levigatrice di finitura • Bazo-dimensioj de finado de polvo • Dimensões da base da lixadeira de acabamento</p>
<p>230V~50Hz</p>	<p>Power supply • Зархранване • Tensiune intrare • Napajanje • Напон • Источник питания • Napetost • Тројфазноста • Napajanje • Source de courant • Alimentazione elettrica • Fonte de nutrado • Fonte de energia</p>	<p>10 MPa</p> <p>Maximum pressure • Максимално налягане • Presiune maximă • Максимальный притиск • Максимальное давление • Maksimalni pritisk • Μέγιστη πίεση • Maksimalni pritisk • Pression maximale • Pressione massima • Maksimuma premo • Pressão máxima</p>	 <p>0-45°</p> <p>Cutting angle adjustment • Рязане под ъгъл • Ajustare unghi tăiere • Sečenjenje pod uglom • Сечење под агол • Регулировка угла резания • Nastavljiv kot rezanja • Κοπή ρύθμιση γωνίας • Kut rezanja • Réglage de l'angle de coupe • Regolare l'angolo di taglio • Angleustiga angulo • Ajuste do ângulo de corte</p>
<p>760 W</p>	<p>Bolt thread dimensions • Размер на рязаната на болта • Dimensiunea de fire suruburi • Veličina zafatovske nit • Големина на завоите на завртката • Размер резьбы болтов • Velikost vijakov nit • Μέγεθος σπειρώσεως της βίδας • Iznos vijak nit • Dimensions du filetage du boulon • Dimensioni della filettatura del bullone • Dimensio de rigillo • Dimensões da rosca</p>	 <p>Ø [mm] 210x30mm</p> <p>Circular disc dimensions • Размери на диска за циркулар • Dimensiuni disc • Dimenzije diska • Размер на дискот • Диск размери • Velikosti diska • Διαστάσεις δίσκου • Veličina kružnog diska • Dimensions du disque circulaire • Dimensions du disque circulaire • Dimensioj do disko circular • Dimensões do disco circular</p>	
<p>0-2600 min⁻¹</p>	 <p>115 mm</p> <p>Maximum diameter of grinding disc • Макс. диаметър на шлифовъчния диск • Diametru maxim disc slefuire • Maksimalni prečnik diska za šljafovanje • Макс. дијаметар на дискот за брусење • Максимальный диаметр шлифовального диска • Največji premer brusilnega diska • Μέγιστο διάμετρος δίσκου λείαντικού • Max. Promjer brusa • Diamètre maximum du disque de meulage • Diametro massimo del disco di levigatura • Maksimuma diametero de muelanta disko • Diâmetro máximo do disco de moagem</p>	 <p>0-3 mm</p> <p>Planning depth • Дълбочина на рендосване • Adâncime maximă prelucrare • Dubina renđanja • Длабочина на струганье • Глубина строгания • Nastavljiva globina ulora • Βόθος πλάνωσης • Dubina planiranja • Profondeur de planification • Profondità di pianificazione • Planado de profundo • Profundidade de planeamento</p>	
<p>2 kg</p>	 <p>22.2 mm</p> <p>Inner diameter of the disc • Втрешен дијаметър на диска • Diametru interior disc • Unutrašnji prečnik diska • Налон • Внутренний диаметр дисков • Внатрешен дијаметар на дискот • Егстерниј дијаметрос του δίσκου • Unutarnji promjer diska • Diamètre intérieur du disque • Diametro interno del disco • Interna diametero de la disko • Diâmetro interno do disco</p>	 <p>82 mm</p> <p>Planning maximum width • Макс. ширина на рендосване • Latime maximă prelucrare • Maksimalna širina renđanja • Макс. ширина на струганье • Ширина строгания • Nastavljiva širina • Πλάτος πλάνωσης • Širina blanjanja • Planifier la largeur maximale • Pianificazione della larghezza massima • Planante maksimuman larçon • Largura máxima de planeamento</p>	
	<p>Variable speed • Регулируеми обороти • Viteza variabila • Podešavanje broja obrtaja • Варијација на вртежи • Регулируемая скорость • Nastavljiva hitrost • Ρυθμιζόμενη ταχύτητα • Podestvi brzine • Vitesse variable • Velocità variabile • Varia rapido</p>	 <p>Spindle lock • Блокаторка на вала • Buton blocare ax • Blokator talasa • Блокада на вратилото • Блокаторка шпинделя • Snemalni gumb • Το κλειδίωμα του άξονα • Zaključavanje osovine • Blocage de la broche • Blocco del mandrino • Spinita seruro • Bloqueio do eixo</p>	
	<p>Left - right rotations • Реверс • Rotatie stanga-dreapta • Rotacija u oba smera • Реверс • Реверс • Leva - desna rotacija • Αντίστροφον • Reverzna Rotations gauche - droite • Rotazioni sinistra-destra • Maldekstre-dekstraj rotacioj • Rotações esquerda-direita</p>	 <p>Ø max 13 mm</p> <p>Maximum diameter of equipment • Максимален дијаметър • Diametru maxim accesorii • Maksimalni prečnik • Максимален дијаметар на опремата • Максимальный диаметр оборудования • Maksimalni premer orodja • Μέγιστο διάμετρος του εξοπλισμού • Maksimalni promjer • Diamètre maximum de l'équipement • Diametro massimo dell'attrezzatura • Maksimuma diametero de ekipajo • Diâmetro máximo do equipamento</p>	
 <p>1.5-13 mm</p>	<p>Chuck diameter • Размер патронник • Diametru interior mandrina • Dimenzije glave bušilice • Дијаметар на футер • Дијаметр патрона • Velikost glave • Тројфазноста • Stezna glava veličina • Diamètre du mandrin • Diametro del mandrino • Chuck-diametero • Diâmetro do mandril</p>	<p>1200 mAh</p> <p>Battery type and capacity • Тип батерија и капацитет • Tip si capacitate baterie • Tip baterije i kapacitet • Тип на батерија и капацитет • Акумулатор и моќност • Моќ батерије • Τύπος μπαταρίας και χωρητικότητα • Vrsta baterije i kapacitet • Type de batterie et capacité • Tipo di batteria e capacità • Tipo de batería kaj kapacito • Tipo de batería e capacidade</p>	 <p>LCD DISPLAY</p> <p>LCD Display • LCD Экран • Display LCD • LCD Ekran • LCD Ekran • LCD екран • LCD дисплеј • LCD Display • Όθονη LCD • LCD zaslón • Affichage LCD Display • Ekranu LCD • Ekranu LCD</p>

	<p>Impact function • Ударна функција • Functie impact • Udarana funkcija • Ударна функција • Импакт функција • Udarana funkcija • Λειτουργία των επιπτώσεων • Udarace funkcija • Fonction d'impact • Funzione d'impatto • Trafo funkcio • Função de impacto</p>	 <p>Max. drilling diameter in metal • Макс. дијаметр на пробиване во метал • Diametru maxim gaurire metal • Maks. prešnik probijanja kroz metal • Макс. дијаметар на дупчење во метал • Макс. дијаметр сверления в металле • Maks. premer vrtnanja v kovino • Μέγιστη διάμετρος τρυπήματος σε μέταλλο • Maks. promjer bušenja u metalu • Max. diamètre de perçage en métal • Max. diametro di foratura in metallo • Maks. boranta diametro em metalo • Max. diâmetro de perfuração em metal</p>	 <p>Device is equipped with bulb or LED • Машината е снабдена со LED диод • Echipat cu bec sau LED • Mašina poseduje LED sijalicu • Уредот е опремен со LED Сижалица • Устройството осначено лампи или светодиоди • Vsebuje žarnico ali LED žarnico • Η συσκευή είναι εξοπλισμένη με λάμπα ή LED • Stroj sa LED diodom L'appareil est équipé d'une ampoule ou d'une LED • Il dispositivo è dotato di lampadina o LED • Aparato estas ekipita per ampolo aŭ LED • Il dispositivo è dotato di lampadina o LED • O dispositivo está equipado com lâmpada ou LED</p>
	<p>Chuck thread • Резба на патронника • Mandrina tip • Navoj glave bušilice • Обем на арлатиното • Tema Чак • Chuck temo • Τροχ θέμα • Stezna glava proizvucte • Fil de mandrin • Filo di Chuck • Chuck-fadeno • Rosca de mandril</p>	 <p>Max. drilling diameter in wood • Макс. дијаметр на пробиване во дрво • Diametru maxim gaurire in lemn • Maks. prešnik probijanja kroz drvo • Макс. дијаметар на дупчење во дрво • Макс. дијаметр сверления в дрвене • Maks. premer vrtnanja v les • Μέγιστη διάμετρος τρυπήματος σε ξύλο • Maksimalni promjer bušenja u drvu • Max. diamètre de perçage dans le bois • Max. diametro di foratura in legno • Maks. boranta diametro em ligno • Max. diâmetro de perfuração em madeira • Energia do martelo por curso</p>	 <p>Working temperature • Работна температура • Temperatura de lucru • Radna temperatura • Работна температура • Рабочая температура • Temperatura • Βερμοκρασία λειτουργίας • Radna temperatura • Temperatura de fonctionnement • Temperatura di lavoro • Laboranta temperatura • Temperatura de trabalho</p>
	<p>Chuck diameter • Размер патронник • Diametru interior mandrina • Dimenzije glave bušilice • Дијаметар на футер • Дијаметр патрона • Velikost glave • Τροφοδοσία • Veličina stezna glava • Diamètre du mandrin • Diametro del mandrino • Chuck-diameter • Diâmetro do mandril</p>	 <p>Max. drilling diameter in concrete • Макс. дијаметр на пробиване во бетон • Diametru maxim gaurire in beton • Maks. prešnik probijanja kroz beton • Макс. дијаметар на дупчење во бетон • Макс. дијаметр сверления в бетоне • Maks. premer vrtnanja v beton • Μέγιστη διάμετρος τρυπήματος σε σπυτό • Maks. promjer bušenja u beton • Max. diamètre de perçage dans le béton • Max. boranta diametro em betono • Max. diâmetro de perfuração concreto</p>	 <p>Flow capacity • Дебит на вдушка • Capacitate de evacuare • Karacitet struje • Капацитет на струјата • Производителност потока • Pretočnost • Ικανότητα ροής • Protok zraka • Capacité de débit • Portata • Flua kapacito • Capacidade de fluxo</p>
	<p>Maximum pump height • Максимална височина на испумпване • Inaltime maxima • Maksimalna visina ispravnjenja • Максимална височина на испумпување • Максимална височина на испумпување • Максимальная высота насоса • Najvišja potisna visina • Μέγιστο ύψος της αντλίας • Maksimalna visina crpljenja • Hauteur maximale de la pompe • Altezza massima della pompa • Maksimuma pumpila alteco • Altura máxima da bomba</p>	 <p>Maximum pump depth • Максимална длабочина на потапане • Adancime maxima • Maksimalna dubina ispravnjenja • Максимална длабочина на испумпување • Максимальная глубина насоса • Največja sesalna visina • Μέγιστο βάθος αντλίας • Maksimalna dubina uranjanja • Profondeur maximale de la pompe • Massima profondità della pompa • Maksimuma pumpila profundo • Profundidade máxima da bomba</p>	 <p>Working temperature • Работна температура • Temperatura de lucru • Radna temperatura • Работна температура • Рабочая температура • Temperatura • Βερμοκρασία λειτουργίας • Radna temperatura • Temperatura de fonctionnement • Temperatura di lavoro • Laboranta temperatura • Laboranta temperatura • Temperatura de trabalho</p>
	<p>Diameter of abrasive disc • Дијаметр на шлифовачниот диск • Diametru disc abraziv • Prešnik diska za šljajovanje • Дијаметар на абразивниот диск • Дијаметр шлифовалног диска • Premer brusilnega diska • Διάμετρος δίσκου των λειαντικών • Promjer brusiva • Diamètre du disque abrasif • Diametro del disco abrasivo • Diametro de abrasiva disko • Diâmetro do disco abrasivo</p>	 <p>Maximum pump depth • Максимална длабочина на потапане • Adancime maxima • Maksimalna dubina ispravnjenja • Максимална длабочина на испумпување • Максимальная глубина насоса • Največja sesalna visina • Μέγιστο βάθος αντλίας • Maksimalna dubina uranjanja • Profondeur maximale de la pompe • Massima profondità della pompa • Maksimuma pumpila profundo • Profundidade máxima da bomba</p>	 <p>Blade length • Дължина на режачната лента • Lungime lama • Dužina trake za sečenje • Должина на сечило • Дина клинка • Dožina rezanja traku • Μήκος λάμας • Duljina rezanja trake • Longueur de la lame • Lunghézza della lama • Klingo longeco • Comprimento da lâmina</p>
	<p>Base dimensions of finishing sander • Размери на шкурката • Dimensiunile bazei de slefuire • Dimenzije šmirgle • Дијаметар на базата на шлајферката • Базовые размеры отделочных шлифовальной • Основна dimenzija brusnega papirja • Διαστάσεις βάσης της τριβείας φινιρίσματος • Veličina brusnini papirnom • Dimensions de base de la ponceuse de finition • Dimensioni di base della levigatrice di finitura • Bazo-dimensioj de finado de polvo • Dimensões de base da lixadeira de acabamento</p>	 <p>Maximum capacity • Максимален дебит • Capacitate maxima • Maksimalni kapacitet • Максимален капацитет • Максимальная мощность • Največji pretok • Η μέγιστη χωρητικότητα • Maksimalni protok • Capacité maximale • Capacità massima • Maksimuma kapacito • Capacidade máxima</p>	 <p>Teeth per inch • Број зъби на инч • Dinti per 1 Inch • Broj zuba po inču • Број на забци на инч • Зуби на дюйм • Številco zob na palec • Δόντια ανά ίντσα • Broj zubi po inču • Dents par pouce • Denti per pollice • Dentoi po colo • Dentes por polegada</p>
	<p>Belt transport speed • Скорост на лентата • Viteza curea transmisie • Brzina trake • Издржливост на ременот • Скорост протегивања ленти • Hitrost krožnega brusilca • Ταχύτητα ταινίας • Brzina trake • Courroie de transport • Velocità di trasporto della cinghia • Rapido de transporte de zono • Velocidade de transporte da correia</p>	 <p>Connector diameter • Дијаметр на конектора • Diametru conector • Prešnik konektora • Дијаметар на конекторот • Конектор дијаметра • Priključek premera • Διαμέτρος σύνδεσης • Promjer priključka • Diamètre du connecteur • Diametro del connettore • Diametro de konektilo • Diâmetro do conector</p>	 <p>Pendulum movement position • Позицији на маховидното движење • Pozitie reglabila • Pozicije klatnastog pomeranja • Позиција на нишане • Положение маятника движење • Nihalnega pretok položaj • Εκκρεμές θέση κίνησης • Položaj kretanja klatna • Pendolo movo pozicio • Posizione del movimento del pendolo • Pendolo movo pozicio • Posição do movimento pendular</p>
	<p>Belt dimensions • Размери на шкурката за лентов шлајф • Dimensiuni curea transmisie • Dimenzija šmirgle za trakasto šljajovanje • Големина на шмирглата • Размери ленти • Dimenzija brusnega traku • Ζώνη διαστάσεις • Veličina papirnom za tračna brusilca • Dimensions de la ceinture • Dimensioni della cinghia • Zonoi • Dimensões da correia</p>	 <p>Device is equipped with laser indicator • Машината е снабдена со лазерен индикатор • Echipat cu indicator laser • Mašina poseduje laserski indikator • Уредот е опремен со ласерски индикатор • Устройството осначено индикатором лазерный • Vsebuje laser • Η συσκευή είναι εξοπλισμένη με δείκτη λέιζερ • Laser • L'appareil est équipé d'un indicateur laser • Il dispositivo è dotato di indicatore laser • Aparato estas ekipita per lasera indikilo • O dispositivo está equipado com indicador de laser</p>	 <p>Blade size • Размер на ножа • Marime lama • Dimenzije noža • Големина на ножот • Размер лезвия • Velikost rezila • Μέγεθος Αστρίδος • Veličina nožem • Taille de la lame • Dimensione della lama • Klingo grandeco • Tamanho da lâmina</p>
	<p>SDS Plus chuck • Патронник SDS+ • Mandrina SDS Plus • Burgija SDS Plus • Футер SDS Plus • SDS plus Чак • Vpetje SDS+ • Τροχ SDS+ • Stezna glava SDS+ • Mandrin SDS Plus • SDS+ chuck • Chuck SDS+ • Mandril SDS Plus</p>	 <p>Disc dimensions • Размери на диска • Dimensiuni disc • Dimenzije diska • Размер на дискот • Диск размери • Velikost diska • Διαστάσεις δίσκου • Veličina diska • Dimensions du disque • Dimensioni del disco • Dimensioj diskoj • Dimensões do disco</p>	 <p>Maximum width of the workpiece • Максимална ширина на обработаниот детал • Dimensiune maxima de prelucrat • Maksimalna širina obradovog predmeta • Максимална ширина на работното парче • Максимальная ширина заготовки • Največja širina obdelovanca • Μέγιστο πλάτος του τεμαχίου • Maksimalna širina kotada • Largeur maximale de la pièce • Larghezza massima del pezzo • Maksimuma largo de la peço • Largura máxima da peça de trabalho</p>
	<p>Score of moment • Въртящ момент • Cuplu maxim • Obrtni momenat • Вртежен момент • Крутящий момент • Моќ в Nm • Potni • Zakretnog momenta • Couple • Momento torcente • Paro • Esforço de torção</p>	 <p>Cutting depth in wood • Дълбочина на рязане во дрво • Adancime taierei in lemn • Dubina seceanja kroz drvo • Длабочина на сечење во дрво • Глубина пропила в дрвесине • Globina reza • Βάθος κοπής σε ξύλο • Dubina rezanja u drvu • Profondeur de coupe dans le bois • Profundità di taglio in legno • Trañca profundo em ligno • Profundidade de corte em madeira</p>	 <p>Cutting angle adjustment • Рязане под ъгъл • Ajustare unghi taiere • Sečenje pod uglom • Сечење под агол • Регулировка угла резания • Nastavljiv kot rezanja • Κοπή ρύθμιση γωνίας • Kut rezanja • Réglage de l'angle de coupe • Regolazione dell'angolo di taglio • Angleustigta angulo • Ajuste do ângulo de corte</p>
	<p>Sockets dimensions • Размер вложки • Dimensiuni adaptori • Dimenzije utičnice • Дијаметар на продолжотокот • Сокетими размери • Višćine dimenzije • Πρίζες διαστάσεις • Veličina umeci • Dimensions des douilles • Dimensiuni prese • Kovrondimensioj • Dimensões dos soquetes</p>	 <p>Planning depth • Дълбочина на рендосване • Adancime maxima prelucrare • Dubina genđanja • Длабочина на стругане • Глубина строгания • Nastavljiva globina utora • Βάθος πλάνοιζησης • Dubina planiranja • Profondeur de planification • Profundità di pianificazione • Planado de profundo • Profundidade de planejamento</p>	 <p>Max load • Максимален товар • Încărcătură maximă • Maksimalno opterećenje • Максимальный товар • Максимальная нагрузка • Največja obremenitev • Μέγιστο φορτίο • Maksimalni opterećenje • Charge maximale • Carico massimo • Maksimuma Sargjo • Carregamento máximo</p>

 <p>196 cm³</p>	<p>Cylinder displacement • Работен обем на двигателя • Dislocare cilindrica • Radna zapremina motora • Работна зафатнина на цилиндричето • Рабочий объем цилиндра • Valja • Κυβισμός • Capacitet motora • Déplacement de cylindre • Cilindrata • Cilindra movo • Deslocamento do cilindro</p>	 <p>HANGER</p>	<p>Hanger packing • Опаковка държач • Agatatore • Pakovanje za držače • Држач пакување • Вешалка упаковане • Obešalnik pakiranje • Крејдстер пакување • Nositelj Pakiranje • Cintre d'emballage • Imballaggio del gancio • Enzepzanta pakumo • Embalagem do gancho</p>	 <p>1/2" inch</p>	<p>Wrench size • За вложки • Dimensiune cliket • За уложке • Големина на вложката • Размер ключа • Velikost ključa • Μέγεθος κλειδού • Za uredelca • Taille de la clé • Misura della chiave • Slosica grandeco • Tamanho da chave</p>
 <p>min H 180 mm</p>	<p>Minimum Jack height • Минимална височина на крика • Inaltime minima cric • Minimalna visina dizalice • Минимална височина на дигалката • Минимална висота гидравлическа буталка • Minimalna visina na hidraulična dvigalka • Ελάχιστο ύψος του υρμού • Minimalna visina utičnica Hauteur minimale du cric • Altezza minima della presa • Mininuma Jack-alteco • Altura minima do macaco</p>	 <p>CASE</p>	<p>Case packing • Купаф • Cutie • Upakovano u koferu • Купфер • Чемодан • Zadeva pakiranje • Υπόβαση του κουφώματος • U koferu Emballage de cas • Imballaggio della cassa • Skatola pakado • Embalagem da caixa</p>	 <p>P max 0.7 MPa</p>	<p>Maximum pressure • Максимално работно налягане • Maxima presiune de lucru • Maksimalni radni pritisk • Максимален работен притисок • Максимальное рабочее давление • Najveća delovni tlak • Μέγιστη πίεση εργασίας • Maksimalni radni tlak • Pression maximale • Pressione massima • Maksimuma premo • Pressão máxima</p>
 <p>max H 340 mm</p>	<p>Maximum Jack height • Максимална височина на крика • Inaltime maxima cric • Maksimalna visina dizalice • Максимална височина на дигалката • Максимална висота гидравлическа буталка • Najveća visina na hidraulična dvigalka • Εύχριστο ύψος του υρμού • Maksimalna visina utičnica • Hauteur maximale du cric • Altezza massima della presa • Maksimuma Jack-alteco • Altura máxima Jack</p>	 <p>BLISTER</p>	<p>Blister packing • Опаковка блистер • Blister • Upakovano u kesi • Блистер пакување • Блистерной упаковки • Pretisni pakiranje • Συσκευασία Κυψέλη • Emballage blister • Imballaggio in blister • Blister-pakado • Embalagem blister</p>	 <p>P 0.5 MPa</p>	<p>Working pressure • Работно налягане • Presiune de lucru • Radni pritisk • Работен притисок • Рабочее давление • Delovni tlak • Πίεση λειτουργίας • Radni tlak • Pression de travail • Pressione lavorativa • Laboranta premo • Pressão no trabalho</p>
 <p>max H 110 mm</p>	<p>Maximum piston stroke • Максимален ход на буталото • Deplasare maxima piston • Maksimalni hod potiskivača • Максимален ход на осовината • Максимальный ход • Najveći gib • Μέγιστη εμβύσμη από το έμβολο • Maksimalni hod • Course maximale du piston • Corsa massima del pistone • Maksimuma streketo • Curso máximo do pistão</p>	 <p>220V-50Hz</p>	<p>Output power • Изходящ ток • Putere iesire • Izlazna struja • Излезна мощност • Выходная мощность • Izhodna moč • Işıkç • Izlazna struja • Puisseance de sortie • Potenza di uscita • Eliga potenco • Potência de saída</p>	 <p>16-40mm</p>	<p>Staples width • Височина на скобите • Latime capse • Širina municije za heftanje • Ширина на муницијата • Ширина скобках • Širina objemke • Πλάτος του σφιγκτήρα • Visina zagradi • Largeur des agrafes • Larghezza delle graffette • Bukjok largo</p>
 <p>max H 50 mm</p>	<p>Maximum movement of the screw • Максимален ход на винта • Miscare maxima a surubului • Maksimalni hod šrafa • Максимален ход на вратилото • Максимальный ход • Najveći hod vijaka • Μέγιστη διότρηση του κοχλία • Maksimalni hod vijak • Mouvement maximal de la vis • Massimo movimento della vite • Maksimuma movado de la ŝraŭbo • Movimento máximo do parafuso</p>	 <p>EN</p>	<p>Manual start the engine • Ръчно стартиране на двигателя • Pomire manuala • Ručno strtaranje motora • Ръчно стартување на моторот • Ручной запуск двигателя • Ručni zagon motorja • Χειροκίνητη εκκίνηση του κινητήρα • Ručno pokretanje motora • Démarrage manuel du moteur • Manuale avvia il motore • Manlirto startigas la motoron • Manual de arranque do motor</p>	 <p>5.7mm 1.2mm</p>	<p>Staples dimensions • Размер на скобите • Dimensiuni capse • Dimenzije municije za heftanje • Големини на муницијата • Размер скобках • Širina objemke • Πλάτος του σφιγκτήρα • Visina zagradi • Largeur des agrafes • Largura dos grampos torpénesh • Velicina zagradi • Largura dos grampos</p>
 <p>3m</p>	<p>Chain length • Дължина на веригата • Lungime lant • Dužina lanca • Должина на ланецот • Длина цепи • Dolžina verige • Μήκος αλυσίδας • Dužina lanca • Longueur de la chaîne • Lunghezza della catena • Cena longo • Comprimento da corrente</p>	 <p>1.6-4mm</p>	<p>Usable electrodes diameter • Диаметър на Електродите • Diametri electrozi acceptati • Прецибн електрода • Диаметар на електродите • Диаметр анектрода • Premier elektrode • Διάμετρος ηλεκτροδίων • Promjer elektrode • Diamètre utilisable des électrodes • Diametro degli elettrodi utilizzabili • Uzebla diametro de elektrodoj • Diámetro de electrodos utilizável</p>	 <p>100 pcs</p>	<p>Number of nails in the magazine • Број пириони в пълнителя • Numărul de cuie în revista • Број екскера у магазину • Број на клинци во пълнителя • Количество гвоздей в магазине • Število žebljev v reviji • Αριθμός κορφιά στο τηροβόιο • Broj noktiju u magazini • Nombre de clous dans la cartouche • Numero di chiodi nella cartuccia • Nombro da ungoj en la kartoto • Número de pregos no cartucho</p>
 <p>500gr</p>	<p>Hydraulic oil capacity • Обем на хидравличното масло • Capacitate ulei hidraulic • Zapremina hidrauličnog ulja • Капацитет на хидравлично масло • Объем гидравлического масла • Hidrauličnega olja zmogljivosti • Υπόρμηκή ικανότητα του πετρελαίου • Capacité d'huile hydraulique • Capacitate olio idraulico • Hidraulička olekapacito • Capacidade de óleo hidráulico</p>	 <p>Ø120 mm</p>	<p>Mixing paddle diameter • Диаметър на бъркалката • Diametru paleta mixare • Прецибн мешалце • Диаметар на мешалката • Диаметром смешивание веслом • Mešanje veslo premera • Ανάμιξη διάμετρο κοππί • Promjer mješalicom • Diamètre de la palette de mélange • Diametro della paletta di miscelazione • Miksante diametron • Diámetro da pá de mistura</p>	 <p>30 pcs/min</p>	<p>Nails per minute • Број пириони в минута • Cuie pe minut • Ekersi in minuti • Клинци во минута • Гвозди в минуту • Željni za minuto • Κορφιά ανά λεπτό • Broj noktiju minuti • Ongles par minute • Unghie al minuto • Najloj por minuto • Unhas por minuto</p>
 <p>500mm</p>	<p>Tile cutting machine workspace length • Дължина на работния плот • Lungime masa de lucru • Dimenzije radne površine • Dimenzi na работна плоча • Dimenzije radne površine • Должина на работната плоча • Длина рабочего стола • Dolžina namizje • Μήκος επιρρεϊκής εργοστασίας • Dužina radna površina • Longueur de l'espace de travail de la machine à couper les carreaux • Lunghezza dell'area di lavoro della troncatrice • Kahela mašino laborspaco longo • Comprimento do espaço de trabalho da máquina de corte da telha</p>	 <p>6-12 m</p>	<p>Rope length • Дължина на въжето • Lungime funie • Dužina užeta • Должина на жакето • Длина троса • Dolžina vrvi • Μήκος σχοινιού • Dužina užeta • Longueur de corde • Lunghezza della corda • Longa šnuro • Comprimento da corda</p>	 <p>15-50mm</p>	<p>Nails length • Дължина на пироните • Lungime cuie • Dužina eksera • Должина на клинците • Гвозди длинои • Željni dolžina • Κορφιά μήκος • Dužina noktiju • Longueur des ongles • Lunghezza dei chiodi • Longa ungoj • Comprimento de unhas</p>
 <p>max 5 mm</p>	<p>Maximum screw diameter • Максимален диаметър на винта • Diametru maxim surub • Maksimalni prečnik šrafa • Максимален диаматар на навојот • Максимальный диаметр винта • Najveći premer vijaka • Μέγιστη διάμετρος του κοχλία • Maksimalni premer vijak • Diamètre maximum de la vis • Diametro massimo della vite • Maksimuma diametro de ŝraŭbo • Diámetro máximo do parafuso</p>	 <p>Ø5.7mm</p>	<p>Diameter of rope • Диаметър на въжето • Diametru de frânghie • Прецибн жакето • Пречник на жакето • Диаметар веревку • Premier vrvi • Διάμετρος του σχοινιού • Promjer užeta</p>	 <p>H D</p>	<p>Nails dimensions • Размер на пироните • Dimensiune cuie • Dimenzije eksera • Големина на клинцот • Гвозди размери • Željni dimenzije • Κορφιά διαστάσεις • Velicina noktiju • Dimensions des ongles • Dimensioni dei chiodi • Dimensijaj ungoj • Dimensões de unhas</p>
 <p>560 mm</p>	<p>Table dimensions • Размери на работния плот • Dimensiuni masa de lucru • Dimenzije radne površine • Dimenzi na работна плоча • Dimenzije radne površine • Dimenzije radna površina • Dimensions de la table • Dimensioni della tabella • Tabla-dimenzioj • Dimensões da mesa</p>	 <p>22 + 1</p>	<p>Torque control range • Степени на регулиране на въртящия момент • Control putere-cupru • Степен regulacije unutrašnjeg momenta • Степен на регулация на въртящия момент • Диапазон управления моментом • Navora območje • Ροπή εύρος ελέγχου • Stupanaj kontrole momenta • Plage de contrôle de couple • Campo di controllo della coppia • Paro kontrolo gamo • Faixa de controle de torque</p>	 <p>0.058"(1.5mm)</p>	<p>Thickness of units of the chain leading • Дебелина на водещите звена • Grosime zale lant • Debljina zubaca • Дебелина на водичата на забецот • Толщина единич цепи ведущих • Debelina vodilnih enot • Πάχος των μονάδων της αλυσίδας οδηγών • Debljina od vodjeć jedinica • Epaisseur des unités de la chaîne en tête • Spessore delle unità della catena che porta • Dikeco de unuoj de la čeno kondukanta • Espessura das unidades da cadeia principal</p>
 <p>DUST CAPTURE ПРАХО-УЛАВЯНЕ</p>	<p>Dust Capture • Прахоулавяне • Prof de extractie • Усисаване • Прав фаќане • Очистка воздуха от пыли • Odseavanje • Ανοροφήση σκόνης • За праšину • Capture de poussière • Cattura della polvere • Kovrilo de Polvo • Captura de poeira</p>	 <p>0-40 000 min⁻¹</p>	<p>Impact rate at no-load speed • Честота на ударите • Rata de impact si viteza in afara sarcinii • Убестлост удараса Брзина на ударот во празен од • Честота ударов на холостом ходу • Скорост • Število udarcev • Αριθμός κρούσεων στο ρελαντί • Убестлост можданог удара • Taux d'impact à la vitesse à vide • Velocità d'impatto a velocità a vuoto • Tráfico-rápidoo senbese • Taxa de impacto na velocidade sem carga</p>	 <p>X 72</p>	<p>Number of units of the chain leading • Број на водещите звена на верига • Capacitate rezervor combustibil • Број zubaca u lancu • Број на занци на ланецот • Число единич цепи ведущих • Število enot v verigi • ki vodijo • Αριθμός μονάδων της αλυσίδας που οδηγεί • Број jedinica vodjeć lanca • Nombre d'unités de la chaîne en tête • Numero di unità della catena che porta • Nombro da unuoj de la čeno kondukanta • Número de unidades da cadeia principal</p>
 <p>3/4"</p>	<p>Threading die diameter • Диаметър на резбата • Tip filet • Прецибн уређајанја • Диаматар на пресекој • Диаметр резбы • Premier navoja • Θέμα διάμετρο • Promjer navoja • Diamètre de filière • Diametro del dado di filettatura • Fadenan diametron • Rosqueamento die diámetro</p>	 <p>CONCRETE</p>	<p>Drilling in concrete • Пробиване в бетони • Gaurire in beton • Пробивање кроз бетон • Дупчење во бетон • Сверления в бетоне • Vrtanje v betonu • Διότρηση σε υμετόν • Бушење в бетон • Max. diamètre de perçage dans le béton • Maks. boranta diámetro en betono • Max. diámetro de perforação concreto</p>	 <p>0.325"</p>	<p>Chain pitch • Стълка на веригата • Pas pentru lant • Korak lanca • Вредност на веригата • Шар цепи • Ρογωνος κορακ • Βήμα αλυσίδας • Koraci lanca • Pas de la chaîne • Passo della catena • Cēmpafo • Passo em cadeia</p>

 <p>2.8 cfm 79.2L/min</p>	 <p>Ø 1.4 mm</p>	 <p>0.8, 3.2 Ø mm</p>
 <p>52 cm</p>	 <p>600ml</p>	 <p>1/4"</p>
 <p>50-250cm</p>	 <p>180 220mm</p>	 <p>DUST BAG 80L</p>
 <p>7500min⁻¹</p>	 <p>210 Ah</p>	 <p>102mm</p>
 <p>5000min⁻¹</p>	 <p>3 A</p>	 <p>x50</p>
 <p>255mm</p>	 <p>18 V</p>	 <p>METAL</p>
 <p>4 tons</p>	 <p>COLOR BOX</p>	
 <p>3functions</p>	 <p>impeller x6</p>	 <p>60 mm</p>
 <p>3.5 J</p>	 <p>Smax 8 m</p>	 <p>750 mm 520 mm</p>
 <p>610mm (max)</p>	 <p>2xGEARS</p>	 <p>500m³/h</p>
 <p>65 mm</p>	 <p>6 mm</p>	 <p>460mm</p>
 <p>8 mm</p>	 <p>2.4 mm</p>	 <p>max 11 mm</p>

 <p>Maximum drilling diameter with holesaw arbor • Макс. диаметър на пробиване с боркорона • Diametru maxim gaurire carota • Maks. prečnik probijanja s krunsa glava • Макс. дијаметар на дупчење с круна • Макс. дијаметр сверления с коронка • Максимални premer vranja kruna • Διаметρος τριτημότητος σε κορυφή • Bušenje s Kruna • Diamètre de perçage maximum avec arbre de sciage • Diametro massimo di foratura con albero a sega • Maksimuma borado diametro kun holeaw arbor • Diâmetro máximo de furação com mandril de furos</p>	 <p>Power settings • Степени на мощност • Setările de putere • Postavke napajanja • Степени на моќност • Настройби лпитания • Nastavivne porabe • Ρυθμίσεις ενέργειας • Postavke napajanja • Paramètres de puissance • Impostazioni di potenza • Potencaj ardoj • Configurações de energia</p>	 <p>Maximum width of the workpiece • Максимална ширина на обработаниа детал • Dimensiune maxima de prelucrat • Maksimalna širina obradivog predmeta • Максимална широчина на работното парче • Максимална ширина заготовки • Najveća širina obdelovanca • Μέγιστο πλάτος του τεμάχιου • Maksimalna širina komada • Largeur maximale de la pièce • Larghezza massima del pezzo • Maksimuma largo de la peco • Largura máxima da peça de trabalho</p>
 <p>10 000-18 500 Oscillations • Осцилации • Oscilație • Oscilacije • Oscilazioni • Осцилляция • Oscilacija • Ταλάντωσις • Osciliranja • Oscillations • Oscillazioni • Osciljo • Oscilações</p>	 <p>20m³ Heated area • Отопляема площ • Zona încălzită • Grejana površina stambenih • Загрева површина • Отапливаемое помещение • Ogrrevani prostor • Огриваемый периметр • Grijnuta prostori • Zone chauffée • Area riscaldata • Varmigita areo • Area aquecida</p>	 <p>160mm Planning depth • Дълбочина на рендосване • Adancime maxima prelucrare • Dubina gendanja • Длабочина на струганье • Глубина строгания • Nastavljiva globina utora • Βάθος πλάνωσης • Dubina planiranja • Profondeur de planification • Profundità di planificazione • Planado de profundo • Profundidade de planejamento</p>
 <p>3.2° Oscillations angle • Ъгъл на осцилациите • Unghiul Oscilație • Oscilacije uga • Осцилации под агол • Угол Осцилляция • Kot Oscilacija • Γωνία Ταλάντωσις • Kut Osciliranja • Angle des oscillations • Angulo delle oscillazioni • Osciljo-angulo • Angulo de oscilação</p>	 <p>L: 23cm W: 22cm H: 31.5cm Length, width and height • Дължина, ширина и височина • Lungimea, lățimea și înălțimea • Dužina, širina i visina • Должина, ширина и висина • Дина, ширина и висота • Dožina, širina i visina • Μήκος, το πλάτος και το ύψος • Dužina, širina i visina • Longueur, largeur et hauteur • Longeur, largeur et hauteur • Longueur, largeur et hauteur • Comprimento, largura e altura</p>	 <p>45 mm (max) Maximum cutting depth • Максимална дълбочина на рязане • Adancime maxima de taiere • Maksimalna dubina sečenja • Максимальная глубина пропила • Najveća globina reza • Μέγιστο βάθος κοπής • Najveća dubina rezanja • Profondeur de coupe maximale • Massima profondità di taglio • Maksimuma tranča profundo • Profundidade máxima de corte</p>
 <p>4-5min Warm-up time • Време за загревање • Timp de încălzire • Vreme zagrevanja • Време за загревање • Време прогреева • Cas toplo • Χρόνος προθέρμανσης • Toplo - vrijeme • Temps de préchauffage • Tempo di riscaldamento • Varmiga tempo • Hora de aquecimento</p>	 <p>370L Ingoing amount air • Входящо количество въздух • Intrări aer • Uazaj vazduha • Додовен количество въздух • Входящий воздух • Vhod zraka • Εισροδο αέρα • Uleza zraka • Quantité d'air entrant • Quantidade d'aria in entrata • Enirado de aero • Quantidade de entrada de ar</p>	 <p>610 mm (max) Cutting length • Дължина на рязане • Lungime taiere • Dužina sečenja • Должина на сечење • Дина реза • Dožina rezanja • Κοπή μήκος • Duljina rezanja • La longueur de coupe • Lunghezza di taglio • Tranča longo • Comprimento de corte</p>
 <p>LIQUID 4.5 gr/min Liquid volume • Капацитет • Volum • Capacitet • Капацитет • Емкость • Zmogljivost • Χωρητικότητα • Capacitet • Volume de liquide • Volume liquido • Likva volumen • Volume liquido</p>	 <p>OUT 310L Outgoing air quantity • Изходящо количество въздух • Cantitate de aer de iesire • Odlazni količina vazduha • Појдовен количество въздух • Изходящее количество воздуха • Odhodni količina zraka • Εξέρχόμενη ποσότητα αέρα • Odlazni količina zraka • Quantite d'air sortant • Quantita d'aria in uscita • Kvanto de ekstera aeron • Quantidade de ar de saída</p>	 <p>SPEED 270 km/h Flow rate • Скорост на струята • Debitul • Protok • Брзина на млазот • Скорост потока • Pretok • Ένας ρυθμός ροής • Protok • Débit • Portata • Fluo-rapidece • Quociente de vazão</p>
 <p>Ø1.3 mm Nozzle diameter • Диаметър на дюзата • Diametru duza • Prečnik mlaznice • Диаметар на дианата • Диаметр сопла • Premer šobe • Διаметρος ιπτεκ • Promjer mlaznice • Diamètre de la buse • Diametro dell'ugello • Nozzle diameter • Diâmetro do bico</p>	 <p>LEAVES BAG 45 L Capacity bag leaves • Капацитет на торбата за листа • Frunze sac Capacitate • Capacitet jastuk lišće • Капацитет на торбата за листови • Вместимость мешка листвя • Zmogljivost torba lista • Φύλλα σακούλα χωρητικότητας • Kapacitet jastuka lišće • Capacité sac feuilles • Foglie di capacità • Folio de sako • Folhas de saco de capacidade</p>	 <p>14 m³/min Capacity • Капацитет • Volum • Capacitet • Капацитет • Емкость • Zmogljivost • Χωρητικότητα • Capacitet • Capacità • Capacita • Kapabilo • Capacidade</p>
 <p>max 300mm Maximum piston stroke • Максимален ход на буталото • Deplasare maxima piston • Maksimalni hod poiskivača • Максимален од на осовината • Максималний ход • Najveći gib • Μέγιστο εκκευράλο εκτελεστικό • Maksimalni hod • Course maximale du piston • Corsa massima del pistone • Maksimuma strekoto • Curso máximo do pistão</p>	 <p>300mm Width of milling • Ширина на фрезование • Lățime de frezare • Širina mletvenja • Ширина на глодање • Ширина фрезирования • Širina rezkanje • Πλάτος αλεση • Širina glodanje • Largeur de fraisage • Larghezza della fresatura • Largeco de moľigo • Largura da moagem</p>	 <p>Ø220mm Blade Diameter • Диаметър на ножа • Diametru lamă • Prečnik oštrica • Диаметар на ножот • Диаметр лезвия • Premer rezila • Διаметρος λεπίδας • Promjer noza • Diamètre De La Lame • Diametro lama • Klingo Diameter • Diâmetro da Lâmina</p>
 <p>200mm Milling depth • Дълбочина на фрезование • Adâncime de rutare • Dubina rutiranje • Длабочина на мелене • Глубина фрезирования • Globine rezkanja • Βάθος βροχολόνησης • Dubine glodanja • Profondeur de fraisage • Profondità di fresatura • Muelanta profundo • Profundidade de moagem</p>	 <p>3x1.5mm² Type of cable • Вид на кабела • Tipul de cablu • Tip kabela • Вид на кабелот • Тип кабела • Vrsta kabela • Τύπος καλωδίου • Vrsta kabela • Type de cable • Tipo di cavo • Tipo de kablo • Tipo de cabo</p>	 <p>max 35mm Maximum size of solids • Максимален размер на твърдите частици • Dimensiunea maximă a solidelor • Maksimalna velčina čvrstih materija • Максимална големина на цврсти материји • Макс. размер твърдых частиц • Maksimalna velikost trdnih delcev • Μέγιστο μέγεθος των στερεών • Maksimalna veličina krutih tjelesa • Taille maximale des solides • Dimensione massima dei solidi • Maksimuma grandeco de solidoj • Tamanho máximo de sólidos</p>
 <p>65mm Cutting depth in wood • Дълбочина на рязане в дрво • Adancime taiere in lemn • Dubina sečenja na drvo • Длабочина на сечење во дрво • Глубина пропила в дрвесине • Globina reza • Βάθος κοπής σε ξύλο • Dubina rezanja u drvu • Profondeur de coupe dans le bois • Profondità di taglio in legno • Tranča profundo in ligno • Profundidade de corte em madeira</p>	 <p>6 mm Hose inner diameter • Втрешен дијаметър на маркува • Diametru interior furtun • Unutrašnji prečnik creva • Дијаметр стожки крева • Втрешен и надворешен дијаметар на црево • Внутренний диаметр шланга • Notranji premer cevi • Σωλήνας εσωτερικής διαμέτρου • Unutarnji promjer cijeva • Diamètre intérieur du tuyau • Diametro interno del tubo • Diâmetro interno da mangueira</p>	 <p>460mm Blade length of hedge trimmer • Дължина на ножа на рязачка за храсти • Lungime lama trimmer • Dužina noža za sečenje živina • Должина на ножот на тримерот за трева • Дина клинка хедж-тример • Dožina gromje nož • Μήκος λίκας του κλαδευτήρι • Duljina noža trimera • Longueur de lame du taille-haie • Lunghezza della lama del tagliapieti • Klingo longeco de hego trimmer • Comprimento da lâmina do aparador de cerca viva</p>
 <p>8 mm Maximum cutting depth in metal • Макс. дълбочина на рязане в метал • Adancime maxima de taiere in metal • Maksimalna dubina sečenja kroz metal • Максимална длабочина на сечење во метал • Максимална глубина резания металлов • Najveća globina reza u kovino • Μέγιστο βάθος κοπής μετάλλων • Maks. dubina rezanja u metalu • Profondeur de coupe max en métal • Massima profondità di taglio in metallo • Maksimuma tranča profundo en metalo • Profundidade máxima de corte em metal</p>	 <p>2.4 mm Cord diameter • Диаметър на кордата • Diametru cablu • Prečnik strune • Диаметар на кабелот • Шнур диаметро • Niz premer • Διаметρος καλωδίου • Promjer viti • Diamètre du cordon • Diametro del cavo • Korda diameter • Diâmetro do cabo</p>	 <p>max 11 mm Cutting capacity (max) • Рязане капацитет (max) • Capacitate maxima taiere • Capacitet sečenja (max) • Макс. Капацитет на сечење • Режущая способность (макс) • Rezanje (max) • Δυνατότητα κοπής (макс) • Rezanje kapaciteta (max) • Capacité de coupe (max) • Capacità di taglio (max) • Trančanta kapacito (maksimumo) • Capacidade de corte (max)</p>
 <p>8m 5.9 FT Cable cord length • Дължина на кабела • Lungime cablu alimentare • Dužina kabela • Должина на кабелот • Дина кабела • Dožina kabela • Καλώδιο μήκος • Duljina kabela • Longueur du cordon • Lunghezza del cavo • Longa šnuro de kablo • Comprimento do cabo</p>	 <p>280mm Grass cutting diameter • Диаметър на косене • Diametru taiere iarba • Prečnik košenja • Диаметар на косење • Диаметро стрижки травы • Premer pri rezanju • Διаметρος κοπής χόρτου • Promjer košnju • Diamètre de coupe de l'herbe • Diametro di taglio dell'erba • Herbo de diametro • Diâmetro de corte de grama</p>	 <p>11 25-70mm Liquid range vertical • Височина на пръскане • Înălțimea pulverizare • Visina sprej • Висина на пръсканье • Высота распыления • Visina Sprej • Ύψος ψεκασμού • Visina prskanje • Gamme de liquide verticale • Gamma di liquidi verticale • Likva gamo vertikala • Vertical liquido</p>
 <p>6.5x9.5mm 1.45mm L (max) Hose inner & outer diameter • Втрешен и външен дијаметър на маркува • Diametru interior-exterior furtun • Unutrašnji i srojašnji prečnik creva • Втрешен и надворешен дијаметар на црево • Шланг внутренний и внешний диаметр • Notranji in zunanji premer cevi • Σωλήνας εσωτερική & εξωτερική διαμέτρου • Unutarnji i vanjski promjer cijeva • Diamètre intérieur et extérieur du tuyau • Diametro interno ed esterno del tubo • Hoso ena kaj kšistera diameter • Diâmetro interno e externo da mangueira</p>	 <p>60L Oil tank capacity • Обем на резервоара за масло • Capacitate rezervor ulei • Zapremina rezervnoara za ulje • Капацитет на резервоарот за масло • Емкость масляного бака • Prostornina rezervoarja olja • Χωρητικότητα δευξίου λαδίου • Objem spremnika ulja • Capacité du réservoir d'huile • Capacité del serbatoio dell'olio • Kapacito de nafto-tanko • Capacidade do tanque de óleo</p>	 <p>1.2m Liquid range horizontal • Дължина на хоризонтално пръскане • Evacuare lichid la orizontala • Dužina horizontalnog prskanja • Должина на пръсканье хоризонтално • Дина хоризонтално распыление • Dožina horizontalne razpršila • Μήκος των οριζόντιων ψεκασμού • Duljina horizontalne prskanje • Gamme de liquide horizontale • Gamma di liquidi orizzontale • Likva gamo horizontala • Intervalo liquido horizontal</p>

 <p>Accessory quantity • Брой в комплекта • Nr. Accesorii • Број комада у комплекту • Број на додатци • Аксесуари количество • Dodatna količina • Ποσότητα Αξεσουαρί • Број испорукује • Quantită d'accessoire • Quantită di accessori • Аксесора кванто • Quantidade acessória</p>	 <p>Collet sleeves diameter • Диаметр на цагата • Diametru mandrina freza electrica • Прећник stezne čaure • Диаметар на футер • Цанговий диаметра • Premier stročnic • Διάμετρος τσοκ • Promjer stezne čahure • Diamètre des manchons • Diametro delle maniche delle pinze • Pinča manikoј diametro • Diámetro de mangas</p>	 <p>Fuel tank capacity • Обем на резервоара за гориво • Capacitate rezervor combustibil • Zapremina rezervoara za gorivo • Капацитет на резервоарот за гориво • Емкост топливног бака • Prostornina rezervoarja za gorivo • Χωρητικότητα ρεζερβοαρί • Obujam spremnika goriva • Capacité du réservoir de carburant • Capacità della tanica di benzina • Kapacito de benzinujo • Capacidade do tanque de combustivel</p>
 <p>Hose length • Дължина на маркуча • Lungime furtun • Dužina creva • Должина на црево • Дљина шланга • Dolžina cevi • Μήκος σωλήνα • Duljina crijeva • Longueur du tuyau • Lunghezza del tubo • Longitud de tuboj • Comprimento da mangueira</p>	 <p>Length • Дължина • Lungime • Dužina • Должина • Дљина • Dolžina • Μήκος • Duljina • Longueur • Lunghezza • Dauro • Comprimento</p>	 <p>Guide bar length • Дължина на водечката шина • Lungime lama ghidaj • Dužina vodilice • Должина на водечката шина • Дљина наводљивејаше • Dolžina vodnik meča • Μήκος του οδηγού σιδηροδρομικών • Duljina vodilicom • Longueur du guide • Lunghezza della barra di guida • Longitud de gvidilbro • Comprimento da barra de guia</p>
 <p>Always wear protective mask • Винаги носете предпазна маска • Purtați masca de protecție • Uvek nosite zaštitnu masku • Задолжително користете заштитна маска • Всегда надевайте заштитну маску • Vedno nosite zaščitno masko • Πάντα να φοράτε προστατευτική μάσκα • Uvijek nosite zaštitnu masku • Toujours porter un masque de protection • Indossare sempre una maschera protettiva • Ciam surhavas protektan maskon • Sempre use máscara de proteção</p>	 <p>Sanding sheet dimensions • Размери на шкурката • Dimensiune scula sletuire • Dimenzije šmirgle • Димензија на шмиглата • Шлифовални лист размерами • Vrsilini list dimenzije • Λείανση διαστάσεις φύλλου • Velčina brusnih papirnov • Sempre use máscara de proteção • Dimensões da folha de lixamento</p>	 <p>Fuel consumption • Разход на гориво • Consum combustibil • Potrošnja goriva • Резервоар за гориво • Расход топлива • Poraba goriva • Κατανάλωση καυσίμου • Potrošnja goriva • Consumption de carburant • Consumo de carburante • Konsumo de brulajo • Consumo de combustivel</p>
 <p>Always wear protective earmuffs • Винаги носете антифони • Purtați casti de protecție pentru urechi • Uvek nosite zaštitu za uši • Задолжително користете заштитни наушници • Всегда надевайте заштитные наушники • Vedno nosite zaščitna muffi uho • На φορέςτα πάντα προστατευτικά ακουστικά • Uvijek nosite zaštitne štítkice za uši • Toujours porter des cache-oreilles protecteurs • Indossare sempre cuffie antirumore • Ciam surhavas protektajn orelingojn • Use sempre protetores de ouvido protetores</p>	 <p>Consumption of liquid detergent • Разход на течен препарат • Consum detergent lichid • Potrošnja praškastog preparata • Потрошувачка на течен detergent • Потребление жидкого моющего средства • Poraba tekočega detergenta • Κατανάλωση υγρού απορρυπαντικού • Potrošnja tekući deterđent • Consumption de detergent liquide • Consumo de detergente líquido • Konsumo de likva detergendo • Consumo de detergente líquido</p>	 <p>Auto lubrication • Автоматично смазване на веригата • Auto ungere • Automatsko podmazivanje lanca • Автоматско подмазивање • Автоматическа смазка цепи • Samodejno mazanje verige • Αυτόματη λίπανση • Automatsko podmazivanje lanca • Lubrification automatique • Lubrificazione automatica • Auto lubrikado • Lubrificação automática</p>
 <p>Always wear protective glasses • Винаги носете предпазни очила • Purtați manusi de protecție • Uvek nosite zaštitne naočare • Задолжително користете заштитни наочари • Всегда надевайте защитные очки • Vedno nosite zaščitna očala • На φορέςτα πάντα προστατευτικά γυαλιά • Uvijek nosite zaštitne naočale • Toujours porter des lunettes de protection • Indossare sempre occhiali protettivi • Ciam surhavas protektajn okulvitrojn • Use sempre óculos de proteção</p>	 <p>Consumption of powder detergent • Разход на прахов препарат • Consum detergent pudra • Potrošnja praškastog preparata • Потрошувачка на прахаст detergent • Потребление стирального порошка • Poraba pralnega praška • Η κατανάλωση του απορρυπαντικού σε σκόνη • Potrošnja pripreme praħa • Consumption de detergent en poudre • Consumo de detergente em pó • Konsumo de pulvoro lavita • Consumo de detergente em pó</p>	 <p>Response time of the brake • Време за реагиране на спирачката • Timp raspuns frana • Vreme aktiviranja kočnice • Време на реагирање на спирачката • Време сработивања тормозной • Odzivni čas zavore • Ο χρόνος απόκρισης του φρένου • Vrijeme odziva kočnice • Temps de réponse du frein • Tempo di risposta del freno • Tempo de resposta de la bremsa • Tempo de resposta do freio</p>
 <p>SDS-plus Tip • Захват SDS-plus • Tip SDS Plus • SDS-plus Tip • SDS Plus Тип • Пика SDS-Plus • SDS-plus Tip • Корупиј SDS-plus • Nositelj SDS-plus • Conseil SDS-plus • Suggestimento SDS-plus • SDS-plus Tip • Dica SDS-plus</p>	 <p>Knapsack mist dust tank capacity • Обем на контейнера на моторна прскачка • Capacitate rezervor atomizor • Capacitet rezervoara motorne prskalice • Капацитет на резервоарот на моторната прскалка • Топливни баќ для двигателя распылитель • Prostornina posode motorno škropilnico • Ρεζερвоар καυσίμου για τον κεντρο σπασκιστή • Obujam spremnika motornih prskalica • Capacité du réservoir de dépollueur à dos • Capacità del serbatoio dello sprinero a zaino • Retumilo nebulujo tanko kapablo • Capacidade do tanque do espanador da névoa</p>	 <p>Air hose (ID) • Пневматичен Маркуч (вътрешен диаметър) • Furtun aer (ID) • Crevo (ID) • Воздушни дрво (ID) • Воздушний шланг (ID) • Cev za zrak (ID) • Σωλήνας αέρα (ID) • Pneumatske cijevi (unutarni promjer) • Tuyau d'air (ID) • Tubo dell'aria (ID) • Aera hose (ID) • Mangueira de ar (id)</p>
 <p>SDS-plus adapter • SDS-plus адаптер • Adaptor SDS plus • SDS-plus adapter • SDS Plus Адаптер • SDS-plus adapter • SDS-plus adapter • Προσρορηυαίο • SDS-plus adapter • Adaptateur SDS-plus • Adattatore SDS-plus • SDS-plus adaptilo • Adaptador SDS-plus</p>	 <p>Compressor tank capacity • Обем на контейнера на компресор • Capacitate rezervor compresor • Capacitet rezervoara compresora • Капацитет на резервоарот на компресорот • Компресорска баќа • Prostornina posode kompresorja • Συζητεοτής χωρητικότητα της δεξαμενής • Obujam spremnika kompresorov • Capacité du réservoir du compresseur • Capacità del serbatoio del compressore • Kapacito de la kompresoro • Capacidade do tanque do compressor</p>	 <p>Air inlet (NTP) • Вход (NTP) • Conector furtun aer (NTP) • Ulaz (NTP) • Влез на воздухот • Вход для воздуха (NTP) • Dvovod zraka (NTP) • Εισόδος αέρα (NTP) • Ulaz (NTP) • Entrée d'air (NTP) • Air inlet (NTP) • Aera emrejo (NTP) • Entrada de ar (NTP)</p>

ЕВРОМАСТЕР Импорт-Експорт ООД

Р. България, 1231 София,
бул. "Ломско шосе" 246
тел.: 0700 44 155 за цялата страна
e-mail: info@euromasterbg.com
www.euromasterbg.com

EUROMASTER Import Export Ltd.

Bulgaria, 1231 Sofia,
246 Lomsko Chaussee Blvd.
tel.: (00 359) 87 530 0101
e-mail: info@euromasterbg.com
www.euromasterbg.com

EUROMASTER SRL Romania

Str. Drumul Garii Otopeni,
Nr. 6, Otopeni, Ilfov
Tel.: +4 021 3510106
e-mail: info@euromasters.ro
www.euromasters.ro

"Евромастер Импорт - Експорт" ООД, информира, че авторските права на този каталог, включващи неговия текст, поместените фотографии, пиктограми, схеми, чертежи и дизайн, принадлежат изключително на "Евромастер Импорт - Експорт" ООД и подлежат на правна защита съгласно „Закона за авторското право и сродните му права“ влязъл в сила на 01.08.1993 г. и последните изменения публикувани в „Държавен вестник“ р. 32 от 28 Април 2009 г. Копирането, публикуването, модифицирането с комерсиална цел на каталога, както и на отделни елементи от него без съгласието на "Евромастер Импорт - Експорт" ООД, изразено в писмена форма, е строго забранено и може да доведе до подвеждане под отговорност.

All rights reserved. Euromaster Import - Export Ltd informs that the copyright of this catalog, including its text, photographs, pictograms, diagrams, drawings and designs belong exclusively to Euromaster Import - Export Ltd and are subject to legal protection. Copying, publishing, modifying the catalog with commercial purposes, as well as individual elements thereof without the consent of Euromaster Import - Export Ltd expressed in written form is strictly prohibited and may result in liability.



 070044155

 info@euromasterbg.com

 www.raider.bg

Art. № 108028



Euromaster Import-Export Ltd
Bulgaria
1231 Sofia
246, "Lomsko shaussee" blvd
www.raider.bg
www.euromasterbg.com

